

**S9597-AE-RPT-010**

0910-LP-105-6058

# **U.S. NAVY SALVAGE REPORT F/V EHIME MARU**



**“Distribution Statement A:** This document has been approved for public release and sale; its distribution is unlimited.”





S9597-AE-RPT-010

0910-LP-105-6058

# U.S. NAVY SALVAGE REPORT F/V EHIME MARU



**“Distribution Statement A:** This document has been approved for public release and sale; its distribution is unlimited.”





# Forward

The relocation of EHIME MARU from 2,000 feet to 115 feet, successful search and recovery of the internal spaces and the ultimate relocation to the deep water final resting place was one of the most complex and challenging operations in the history of U.S. Navy salvage. As is always the case in major salvage operations, there are many things that contributed to the successful outcome. Without question, the single most important factor was the dedication and professionalism of every individual involved. The team that came together developed a successful strategy that covered multiple contingencies. When faced with unforeseen impacts of the Ehime Maru's severely damaged keel and the devastating impact of the 9/11 attacks on the World Trade Center and Pentagon, they succeeded by improvising and sheer persistence of will.

Throughout each phase of the operation, salvors, engineers, divers and multiple other talented peoples' skill and sheer determination conquered every obstacle. The innovative planning and attention to detail by SMIT, CROWLEY and multiple Naval Sea Systems Command personnel cannot be overstated. Using all the technologies available, they developed a plan that was flexible enough to ensure success, anticipating environmental and operational challenges including overcoming wave snap loading, developing a means of measuring deflection of the hull at 2,000 FSW and coordinating multiple ROVs to perform a multitude of difficult and unrehearsed operations. The principal support contractors, Oceaneering, Phoenix, and GPC provided outstanding support during the initial planning and survey, and throughout the operation. The subcontractors provided expertise and equipment that made the impossible seem easy. Everyone was prepared and dedicated to complete the mission successfully.

The detailed victim recovery plan developed by Mobile Diving and Salvage Unit One and executed by multiple U.S. Navy and Japanese divers covered every possible contingency. This resulted in the conduct of a painstaking search under hazardous conditions, involving a large staff of divers, with no significant accidents or injuries. MDSU proved the naysayers wrong by "planning the dive, and diving the plan".

The Command Staff under the direction of Rear Admiral Bill Klemm consisted of specialists from a variety of fields. Many of them had never been associated with a salvage operation but they all played significant roles, providing expertise that the salvors needed to complete the mission. By including these specialists in the team, the Fleet was fully prepared to address all issues as they came up.

Despite all of the difficulties presented during this operation, the combined effort of the entire team made history. The full impact of the success of the operation will probably never be known. Some of the innovative techniques tried will help salvors in the future, others may not. All of them taught us to open our minds and look outside of the box when planning operations.

The dedicated effort of all participants of this historic operation led to the successful recovery of all but one of the missing victims. This is an accomplishment that each

## F/V EHIME MARU Recovery and Relocation Report

individual can take pride in, as it was truly a team effort. The memorial pictured below, which includes one of the anchors recovered from Ehime Maru, is a fitting tribute to the victims of this tragedy and should remind all those involved in the recovery of the significance of their efforts to bring a small measure of peace and closure to the families of those lost.



Figure 7-1. EHIME MARU Memorial in Honolulu, Hawaii.





## F/V EHIME MARU Recovery and Relocation Report

Section 5.7.1 – The Dive Team.....	5-39
Section 5.7.2 – The Dive Platform .....	5-41
Section 5.7.3 – Dive Systems and Equipment .....	5-43
Section 5.7.4 – Dive Operations .....	5-46
Section 5.8 – Phase VII: Preparation for Relocation and Release at Deep-water Site ..	5-48
Chapter 6 – Lessons Learned.....	6-1
Section 6.1 – Commitment of Platforms.....	6-1
Section 6.2 – Use of Foreign Flag Vessels .....	6-1
Section 6.3 – Environmental Assessment .....	6-2
Section 6.4 – Planning and Tracking Progress .....	6-2
Section 6.5 – Assessment of the EHIME MARU .....	6-3
Section 6.6 – Selecting The Team.....	6-3
Section 6.7 – Selecting The Equipment.....	6-4
Section 6.8 – International Visibility .....	6-5
Section 6.9 – Cultural Sensitivity Training .....	6-5
Section 6.10 – ROV Visualization Technology .....	6-5
Section 6.11 – ROV Multiple Screen Viewing Technology.....	6-6
Section 6.12 – Coiled Tube Directional Viewing Technology .....	6-6
Section 6.13 – Real-time Meteorology and Oceanography (METOC) and Motion, Stress, and Strain Sensors .....	6-6
Section 6.14 – Communications .....	6-7
Section 6.15 – Public Affairs .....	6-7
Section 6.16 – Tracking Funds.....	6-8
Section 6.17 – Support Platform Characteristics.....	6-8
Section 6.18 – Contingency Planning.....	6-9
Section 6.19 – Use of Reserve Support .....	6-9
Section 6.20 – Documentation.....	6-9
Section 6.21 – Lessons Learned by Contractors .....	6-10
Section 6.22 – Recommendations .....	6-11
Chapter 7 – Conclusion .....	7-1
Appendix A – Acronyms and Abbreviations .....	A-1
Appendix B – Mobilized Assets .....	B-1
Appendix C – Selected Press Releases.....	C-1
Appendix D – Significant Impact and Environmental Assessment Executive Summary ...	D-1
Section D.1 – Finding Of No Significant Impact .....	D-1
Section D.1.1 – Action .....	D-1
Section D.1.2 – Background.....	D-1
Section D.1.3 – Purpose.....	D-1
Section D.1.4 – Description of Proposed Action .....	D-2
Section D.1.5 – Alternatives Considered.....	D-3

Section D.1.6 – Environmental Effects .....	D-3
Section D.1.6.1 – Water Quality .....	D-4
Section D.1.6.2 – Marine Biological Resources.....	D-4
Section D.1.6.3 – Health and Safety .....	D-5
Section D.1.6.4 – Airspace .....	D-6
Section D.1.6.5 – Hazardous Materials and Hazardous Waste.....	D-6
Section D.1.6.6 – Recovery-not-possible Alternative.....	D-7
Section D.1.7 – Conclusion.....	D-8
Section D.2 – Environmental Assessment: Executive Summary.....	D-8
Section D.2.1 – Introduction .....	D-8
Section D.2.2 – Background .....	D-8
Section D.2.3 – Evaluation of Alternative Recovery Methods.....	D-9
Section D.2.4 – Proposed Action and Alternatives.....	D-10
Section D.2.5 – Potential Environmental Effects .....	D-11
Section D.2.5.1 – Current Location .....	D-11
Section D.2.5.2 – Transit to Shallow-water Recovery Site .....	D-12
Section D.2.5.3 – Recovery Plan (Anticipated Releases) .....	D-12
Section D.2.5.4 – Shallow-water Recovery .....	D-14
Section D.2.5.5 – Relocation to Deep-water Site.....	D-15
Section D.2.5.6 – Recovery-Not-Possible Alternative .....	D-15
Section D.2.6 – Conclusion.....	D-16
Appendix E - Correspondence .....	E-1
Appendix F – Contact Information .....	F-1
Appendix G – General Arrangements .....	G-1
Appendix H – Selected PowerPoint Presentations .....	H-1
Appendix I – Press Briefings.....	I-1

**This page was intentionally left blank.**



## **Introduction and Background**

### **1.1 Introduction**

Just before 2 p.m. on February 9, 2001, a Japanese fisheries training vessel, EHIME MARU, was accidentally struck by USS GREENEVILLE (SSN 772), off Oahu, Hawaii. GREENEVILLE was practicing an emergency main ballast tank blow when it struck EHIME MARU. GREENEVILLE experienced minor damages while EHIME MARU suffered catastrophic damages causing her to sink in 2,000 feet of water.

The GREENEVILLE immediately alerted search and rescue (SAR) authorities and U.S. Coast Guard SAR aircraft were on the scene within minutes. USS SALVOR (ARS 52), USS PORT ROYAL (CG 73) and USS LAKE ERIE (CG 70) sortied from Pearl Harbor to assist along with Coast Guard Patrol Boats: KITTIWAKE (WPB 87316), ISKA (WPB 1336), WASHINGTON (WPB 1331), and ASSATEAGUE (WPB 1337). Also on scene were two Navy torpedo retriever boats, HAWTHORN 5 and 8, a P-3 "Orion" with night vision capabilities and an SH-60 "Seahawk." Twenty-six of the thirty-five personnel aboard EHIME MARU were rescued from the water immediately following the collision. For three days subsequent to the collision SAR efforts led by the Coast Guard, and augmented by civilian and U.S. Naval vessels and aircraft, failed to locate the nine missing members of the ship's company.

While the SAR effort was ongoing Submarine Development Squadron Five (SUBDEVRON 5) in San Diego and Naval Sea Systems Command (NAVSEA) in Washington, DC mobilized search teams to perform a subsurface search and survey of the sunken fishing vessel. NAVSEA mobilized the Supervisor of Salvage (NAVSEA 00C) and SUBDEVRON 5 mobilized the DEEP SUBMERGENCE UNIT (DSU) to support the effort. The Supervisor of Salvage (SUPSALV) and DSU both deployed side-scanning sonar and remotely operated vehicle (ROV) teams to Hawaii. After the SAR effort concluded, the search and ROV teams conducted an extensive sonar search of the debris field and a visual survey of the vessel and the surrounding area. As a result of this effort, the Navy concluded that there was a high probability that the missing crewmembers were still inside the vessel.

There were very significant political and diplomatic issues surrounding this event. The Government of Japan requested the recovery of the missing crewmembers, their personal effects and certain unique characteristic components of the ship. Finding and returning the remains of the missing crewmembers became a national priority that would

evolve into one of the most challenging and technically advanced salvage undertakings in U.S. Naval history.

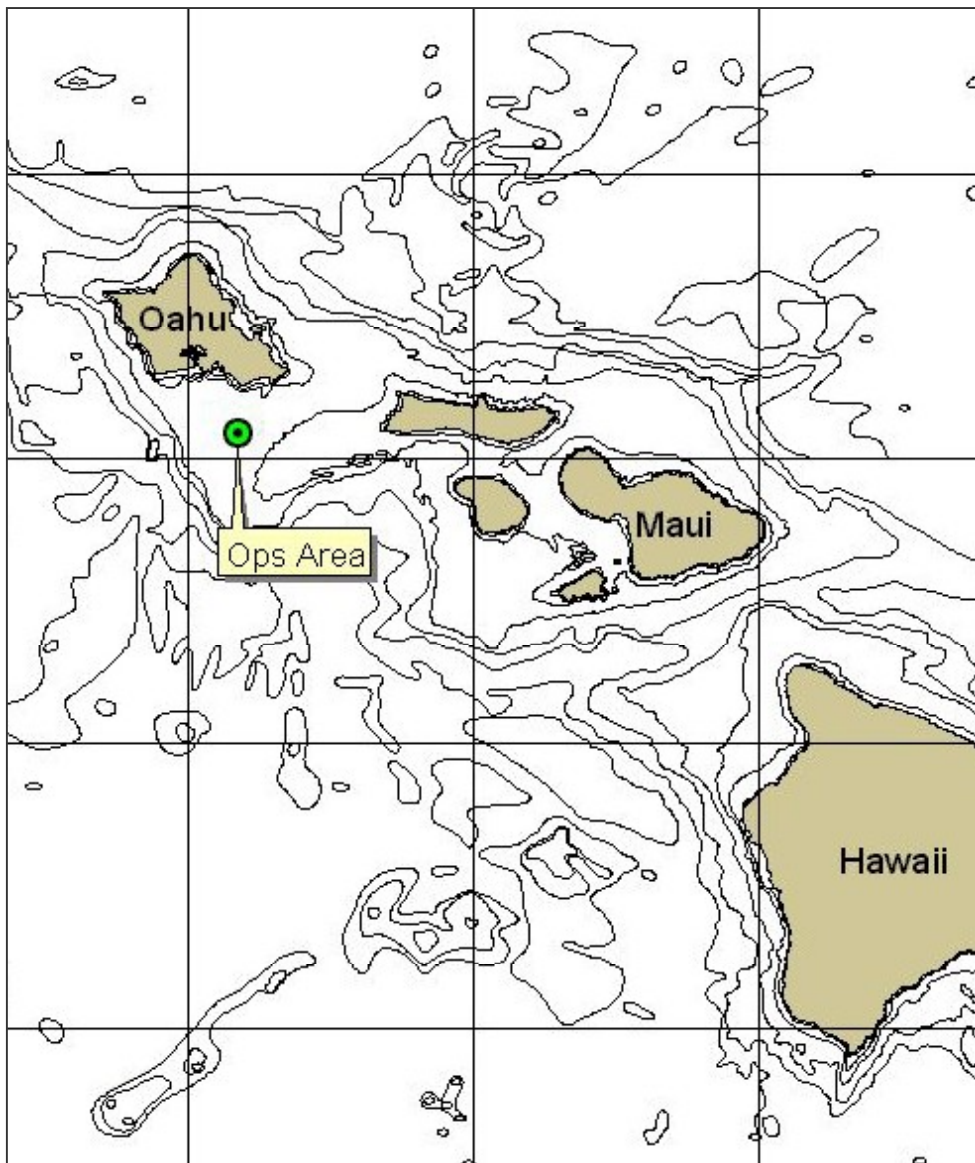

**Figure 1-1. USS GREENEVILLE Operational Area and Accident Location.**

The GREENEVILLE collided with EHIME MARU approximately 9 nautical miles south of Diamond Head, off the island of Oahu, Hawaii. (Figure 1-1) The initial search and survey operations to locate EHIME MARU and its debris on the seafloor were accomplished by DSU and SUPSALV. In an effort to identify the debris field and gather information about the disposition of EHIME MARU and the feasibility of her recovery, DSU provided the ROV Scorpio II, and SUPSALV provided the ROV Deep Drone and the Shallow Water Intermediate Search System (SWISS) side-scan sonar. Scorpio II was operated from M/V C-Commando under contract to the Navy. Both Deep Drone and

SWISS were operated from the SALVOR. As shown in Figure 1-2, all of the debris found on the seafloor was in very close proximity to the EHIME MARU hull.

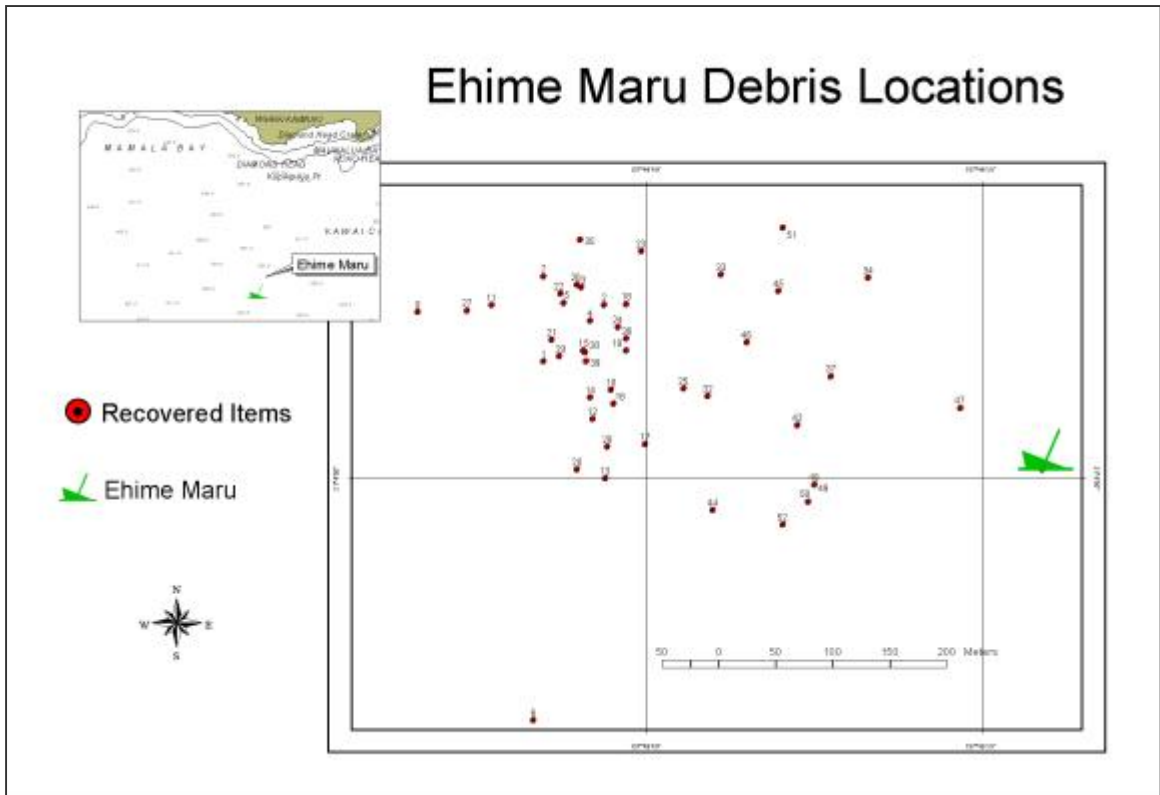

Figure 1-2. EHIME MARU Debris Locations.

The relocation operation involved moving EHIME MARU 14 nautical miles from its location in 2,000 feet of water to a site in 115 feet of water just off the Honolulu Airport. This would enable surface supplied divers to safely enter the hull to search for crewmembers. The initial salvage site was designated the Deep-Water Recovery Site (DWRS) and the shallow site was designated the Shallow Water Recovery Site (SWRS). Upon completion of the diving effort, the EHIME MARU was moved to the Final Relocation Site (FRS) in approximately 8,500 feet of water. Figure 1-3 shows the original location of the EHIME MARU at the DWRS (right), the SWRS (center) and the FRS (left).



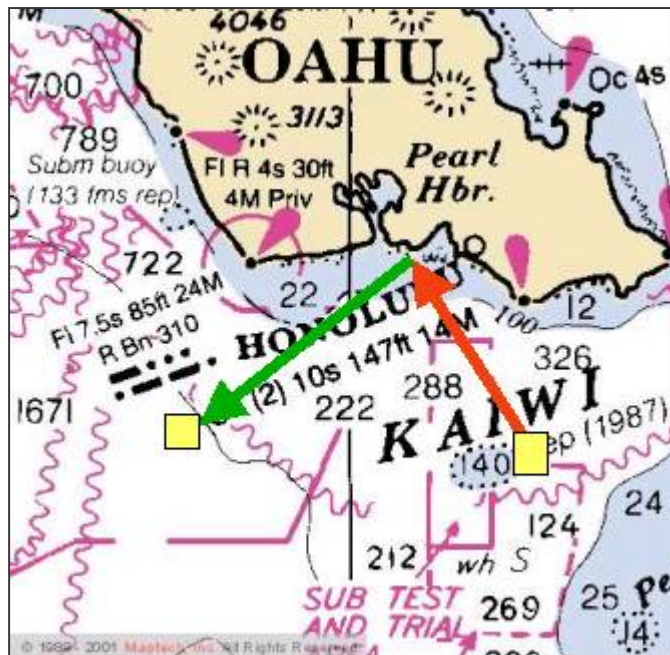

Figure 1-3. EHIME MARU Relocation Sites.

The SWRS is located within the Naval Defense Sea Area (NDSA). Established in 1942 for the protection of Naval assets located within a military installation, the NDSA extends 3 nautical miles south of the reef runway and continues 3.5 miles west to Iroquois Point. This site was chosen to ensure diver safety, protection from weather, environmental concerns, as well as for the safety of the entire recovery team. Only assets authorized by the Secretary of the Navy were allowed in this area during the recovery operation. The SWRS allowed U.S. Navy and Japanese divers to examine the vessel, look for and recover the crewmembers that were believed to be trapped inside and prepare EHIME MARU for its transfer to the deep water FRS.

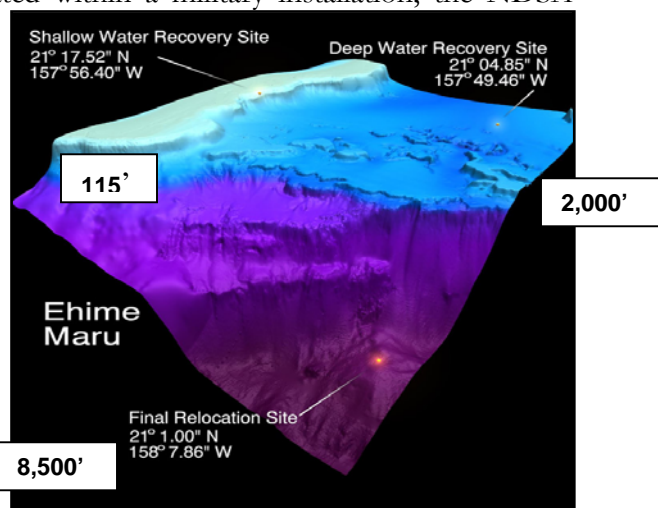

Figure 1-4. 3-D Graphic of EHIME MARU's Relocation.

Relocating EHIME MARU raised diplomatic issues as well as technical and environmental risks. The decision to move the vessel proved to be the right decision, as the remains of eight of the nine crewmembers were found onboard and recovered, without incident, during the diving phase of the salvage effort.

## 1.2 Tasking

Operational tasking of assets and organizations for the entire project was defined in a series of messages from Chief of Naval Operations (CNO), Commander Naval Surface Group, Middle Pacific (COMNAVSURFGRU MIDPAC) and CINCPACFLT (See Appendix E). These messages defined the role of all of the participants in the areas such as:

- Communications
- Salvage
- Diving
- Medical Care
- Meteorology and Oceanography Support
- Logistics
- CONOPS
- Public Affairs
- Environmental Protection

CINCPACFLT tasked Commander Third Fleet (COMTHIRDFLT) to develop an overall plan for the crewmember recovery and relocation. This plan included provisions for security, communications, diving, oil spill preparedness, and response. The plan included estimated force requirements, timeline, and cost of operations. COMTHIRDFLT designated COMNAVSURFGRU MIDPAC as the On Scene Commander reporting daily to CINCPACFLT N43 for direction in all phases of the EHIME MARU relocation and crewmember recovery. COMTHIRDFLT was tasked to provide forces and resources for the purposes of offshore recovery operation of EHIME MARU, location of missing crewmembers and recovery of personal effects. The tasking stated that the mission was not to extend beyond the date of 15 November 2001. Selected excerpts from some of the message traffic communications are provided in Appendix E: Correspondence.

CNO and CINCPACFLT tasked SUPSALV and SUBDEVRON 5 to mobilize their ROVs and side-scan sonars and accomplish a sub-surface search immediately following the accident. SUPSALV used ROV Deep Drone and the SWISS side-scan sonar system while SUBDEVRON 5 used the ROV Scorpio II, locating the vessel quickly and visually surveying the exterior of the hull and surrounding seafloor. The U.S. Navy made the commitment to the surviving family members that if it were technically feasible to raise the EHIME MARU and retrieve the crewmembers, the U.S. Navy would do so. Under the direction of CINCPACFLT, SUPSALV assembled a feasibility study team composed of SUPSALV personnel, NAVSEA 05 (Naval Architects and Engineers), Japanese technical advisors, and SUPSALV's prime salvage contractors in the Pacific, SMIT Salvage and Crowley Marine Corporation. The feasibility study team concluded that recovery of the vessel was feasible.

Naval Instructions that were employed for the tasking of Naval Commands and vessels included:

- Secretary of the Navy Instruction (SECNAVINST 5720.44A. Department of the Navy Public Affairs Policy and Regulations.)
- Chief of Naval Operations Instruction (OPNAVINST 5720.2L. Embarkation in the U.S. Naval Ships.)
- Chief of Naval Operations Instruction (OPNAVINST 4740.2F. Salvage and Recovery Program.)
- Pacific Fleet Instruction (CINCPACFLTINST 5720.2M. Embarkation in U.S. Naval Ships.)
- Pacific Fleet Operations Order (CINCPACFLT OPOD 201)

### **1.3 Scope of Mission**

The primary objective of this mission was to locate and recover the remains of the missing crewmembers of EHIME MARU. To accomplish this, a team of military, civilian and contractors was assembled to develop a recovery plan that encompassed the use of remotely operated vehicles and oil field technologies to relocate the EHIME MARU from 2,000 feet of water to a site where divers could safely enter it and then finally move it to a deep water final relocation place.

As with most major salvage operations, the scope of this mission included more than just completing the salvage. International relations, environmental issues, and media relations were all major elements that required significant attention.

The complexity and scope of the recovery and relocation operation was unparalleled and many expressed doubt that it could be accomplished.

### **1.4 Overview of the Operation**

Immediately following the accident, while the search and rescue effort was ongoing, CINCPACFLT asked SUPSALV if it would be feasible to successfully salvage the EHIME MARU. A detailed video survey was completed as soon as the vessel was located on the seafloor. This provided Navy and SMIT engineers with the data necessary to assess the structural integrity of the vessel and to develop a feasibility study that led to the conclusion that there was a high probability of successfully completing the operation.

Because of the close proximity of the operation to sensitive Hawaii beaches, and the potential of a fuel spill, an Environmental Assessment (EA) was required prior to granting final approval to conduct the operation. This represented a significant effort on the part of many organizations. Fortunately, all of the organizations recognized the importance of the mission and worked tenaciously to complete the EA, which ultimately allowed CINCPACFLT to issue a Finding of No Significant Impact (FONSI), clearing the way to proceed with the operation.

The salvage operation was a straightforward, brute force lift operation. Because of the extreme water depth, environmental concerns, size and weight of the EHIME MARU, public interest, and other issues, it was one of the most complex salvage efforts ever undertaken by the U.S. Navy. Resources from around the world were assembled, modified, manufactured, and mobilized to Hawaii for the operation. In some cases, technologies were adapted from commercial applications that had never been employed in salvage. Because of the heavy work requirements associated with remotely rigging the vessel for lift, the Navy salvage contractors utilized the services of offshore construction companies that specialized in heavy construction of offshore oil platforms in deep water. By combining a team of salvage engineers, salvage masters, offshore riggers, heavy duty Remotely Operated Vehicle (ROV) operators and a host of other specialists, SUPSALV was able to accomplish what some felt was impossible. EHIME MARU was relocated from 2,000 feet to 115 feet to allow divers to safely enter the vessel and search for the nine missing crewmembers.

Diving operations in 115 feet of water are not unusual for Navy divers. However, entering a severely damage ship presented significant challenges and danger. For safety reasons, all divers entering the hull must be surface supplied and tended by another diver outside the entry point. The significant damage and debris inside the hull compounded the risk of entanglement, an ever-present factor when diving inside wrecks. Because of this, Mobile Diving and Salvage Unit One (MDSU1), the command assigned responsibility for conducting the dives, developed a comprehensive and thorough plan. All of the participating divers were intimately familiar with the plan, and extensive training was undertaken prior to commencement of the actual operation. Because of the detail of the plan and the precise execution by MDSU1, the recovery operation was completed in a highly successful and safe manner.

To relocate the EHIME MARU to the final deep water-resting place, SUPSALV and Crowley developed a scheme that proved to be cost effective and successful. Rather than retaining the services of the heavy lift ship used during the initial relocation effort diving phase, the diver support barge was modified to facilitate lifting EHIME MARU using a ballast lift technique, clearing it from the bottom and then transporting it to deep water.

## 1.5 Operational Factors

This operation was complicated by a number of unusual and significant factors. The most important of these were:

- Critical and highly visible operation
- Inaccessible hull damage making assessment of structural integrity speculative
- Limited operational techniques for rigging and lifting the hull due to water depth
- The weight of the hull and dynamics of the lift
- Environmental issues
- Incorporation of non-salvage systems and techniques into a salvage environment
- Significant damage and debris inside the hull, impacting diving operations
- Coordination of mobilization efforts from three continents.

Figure 1-5 shows the depth comparison with two recent salvage operations.

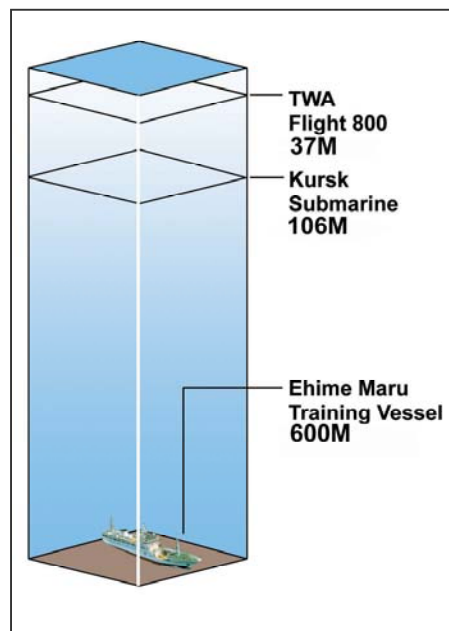

Figure 1-5. Salvage Depth Comparisons.

## 1.6 Purpose and Organization of the Report

This report discusses the technical and operational aspects of relocation of EHIME MARU, recovery of missing crewmembers, and final disposition of the hull. Its purpose is to record the significant accomplishments of those who made the operation a success and to help prepare others for the challenges of the future. With the exception of how they



impacted the operation, political and diplomatic issues surrounding the incident will not be addressed.

All significant salvage and diving operations present unique challenges. While it is impossible to identify them all ahead of time, by studying past operations and their lessons learned, salvors will be better prepared to tackle complex operations. The remainder of this report contains chapters that deal with specific challenges that were encountered. Chapter 2 records the way that the Navy established a command structure that brought together both military and civilian salvage organizations, and other independent agencies. Chapter 3 addresses public affairs and media relations. Chapter 4 addresses the planning and management of the operation. Chapter 5 addresses the eight phases of the operation (0 through VII). Chapter 6 provides lessons learned. Chapter 7 provides a brief conclusion.

**This page was intentionally left blank.**

## **Command and Organization**

### **2.1 Establishing Command**

One of the most important elements that contributed to the success of the recovery and relocation of the EHIME MARU was the timely establishment of an effective operational command structure. This project was a large, multi-disciplinary effort that required well-defined coordination and communication among numerous assets and organizations. In order to effectively control the initial search and rescue effort the U.S. Coast Guard's Incident Command System (ICS) was used to establish a unified command consisting of all of the agencies involved.

The coordination was international in scope and sensitive in nature. In addition to the Navy, several other governmental agencies, salvage and environmental contractors, Japanese governmental officials, salvors, scientists, and divers were integral members of the recovery and relocation team. During Phase 0 of the EHIME MARU project, CINCPACFLT named Rear Admiral William Klemm, as both the Recovery Operational Commander and the Incident Commander for the Unified Command that was established to monitor environmental issues.

The organization brought to the table decades of experience in salvage and environmental monitoring and assessment. This experienced team allowed Rear Admiral Klemm to provide the knowledge needed to respond to questions from the press and the international community pertaining to the environmental impact of the project. As soon as the SAR effort concluded, CINCPACFLT established a Navy command structure similar to the Coast Guard ICS, but more aligned with a military joint task force organization. Many of the individuals and organizations involved remained the same, providing their expertise as needed. This allowed Rear Admiral Klemm to view the project from a higher level overseeing the international relations, operations, planning, logistics and financial aspects of the project. The Unified Command (ICS) worked with the Navy command structure until they stood down after the Environmental Assessment was completed, but remained ready to stand back up if an incident occurred. Figure 2-1 is a diagram of the Unified Command ICS.

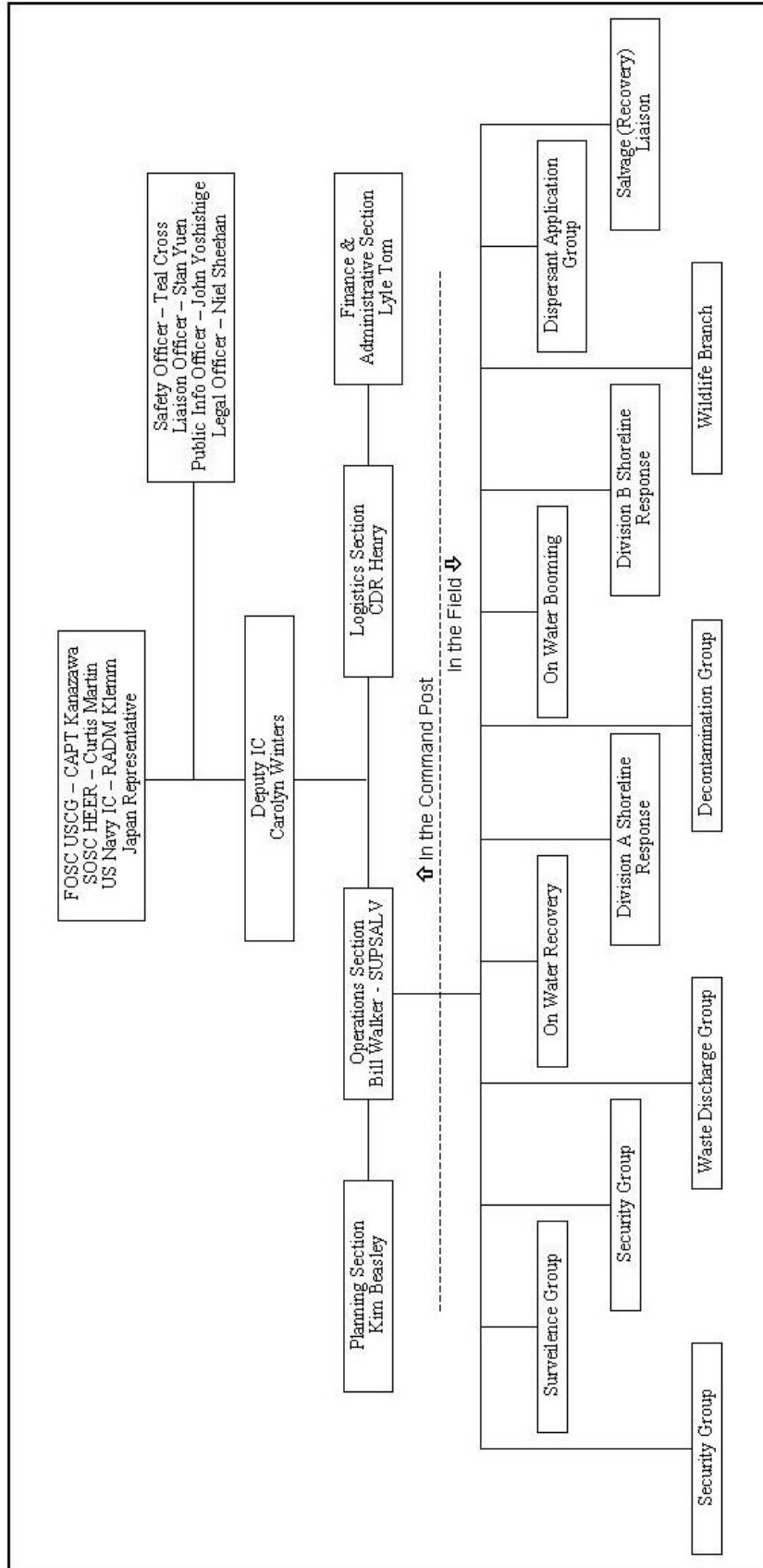

Figure 2-1. EHIME MARU Unified Command ICS Organization.

## 2.2 Participating U.S. Naval Components and Commands

The U.S. Navy organization divided into two operational establishments, the shore establishment and the operating forces. The Naval operational command structure for the EHIME MARU project was multi-faceted and involved both the shore establishment and operating forces. This organization is shown in Figure 2-2.

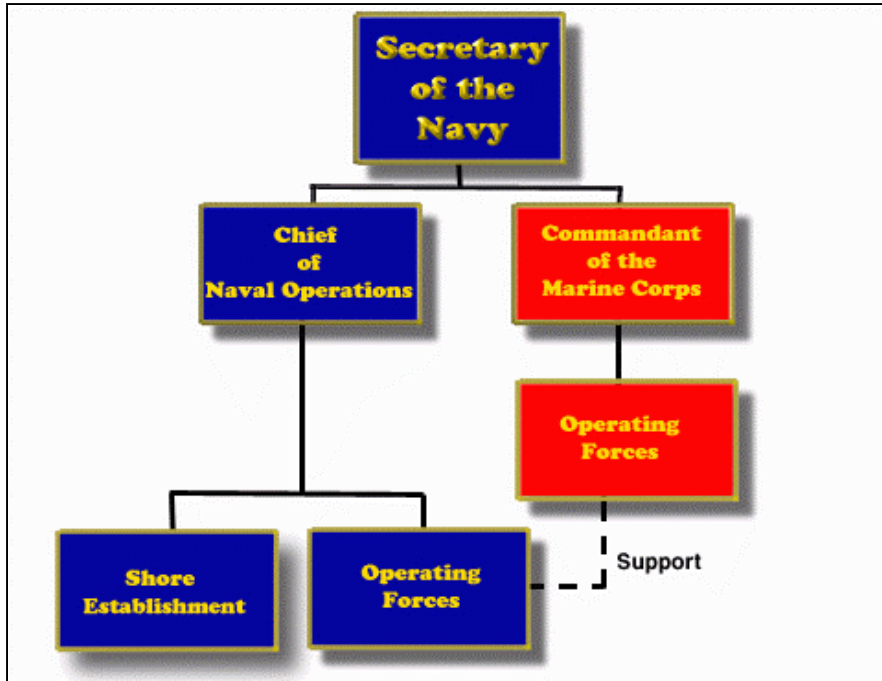

Figure 2-2. U.S. Navy Organization Showing the Navy Operational Organization.

An organization chart of the U.S. Navy Shore Establishment is shown in Figure 2-3. Naval Sea Systems Command and Naval Meteorology and Oceanography Command (METOC) are included in the Navy shore establishment and both participated in the EHIME MARU project. The EHIME MARU feasibility study team was composed of SUPSALV, NAVSEA 05, Japanese technical personnel and salvage engineers and personnel from Smit and Crowley. COMNAVSURFGRU MIDPAC was the On Scene Commander for the relocation effort, but technical direction was the responsibility of SUPSALV. Under the supervision and guidance of SUPSALV, Captain Bert Marsh, the survey, feasibility study, recovery, and relocation took place. The Emergency Ship Salvage Material System, (ESSM) which falls under the command of SUPSALV, provided various salvage and oil spill equipment and personnel. This equipment was supplemented by contractors' equipment throughout the operation. SUPSALV's Deep Drone, operated by Oceanering International during phase 0 and Phoenix International during latter phases, and DSU's Scorpio II, surveyed the seafloor looking for debris and personal effects surrounding the hull of the

EHIME MARU. METOC provided bathymetric surveys and real-time meteorology and oceanographic data collection efforts.

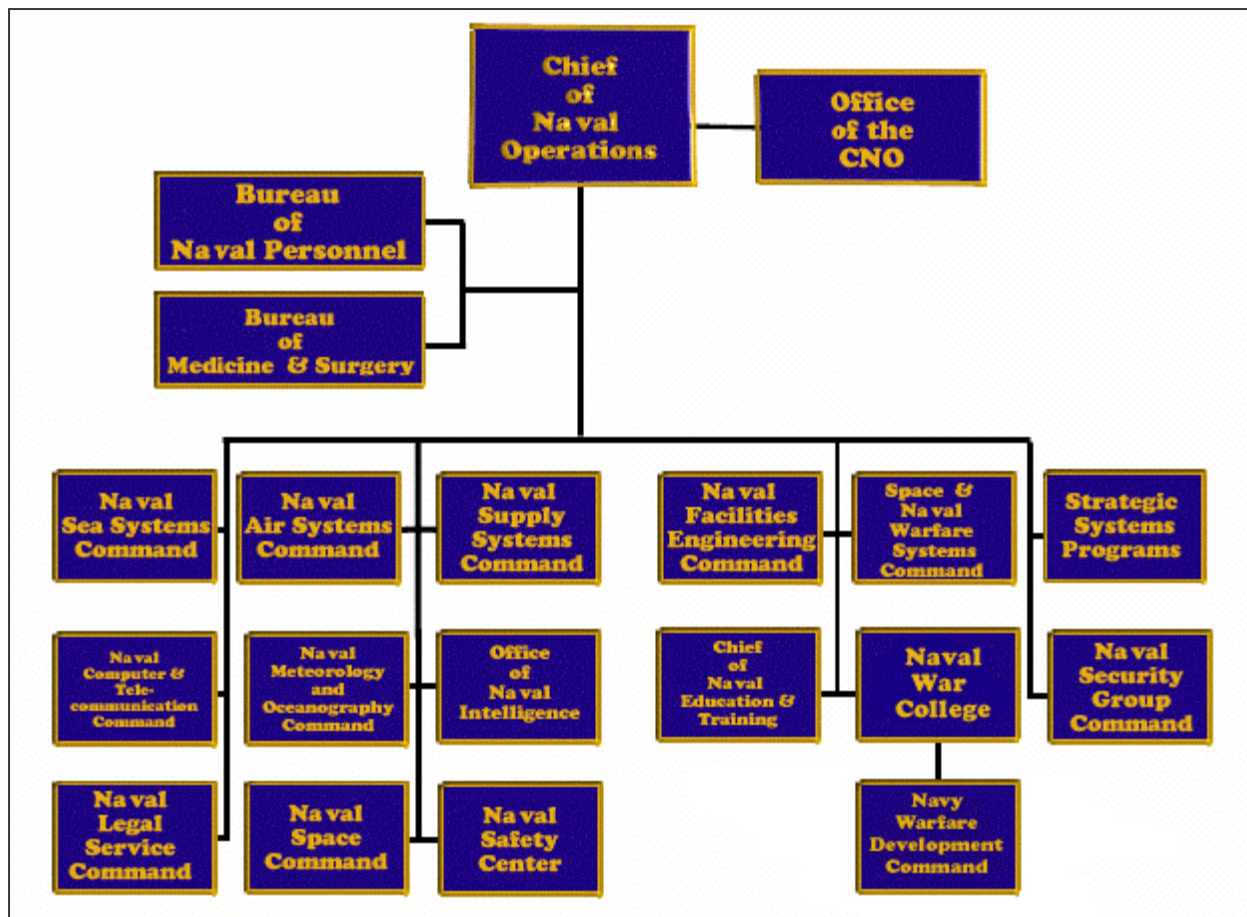

Figure 2-3. Organizational Chart of the U.S. Navy Shore Establishment.

The U.S. Naval Operating Forces organizational chart is shown in Figure 2-4. It includes Naval Reserve Forces, Military Sealift Command, and the Pacific Fleet and the Type Commands within the Pacific Fleet, the Naval Reserve force, and Fleet assets from air, sea, and submarine forces all of whom participated in the rescue and salvage operations. The Deep Submergence Unit from Submarine Development Squadron Five located the EHIME MARU in 2,000 feet of water with the Scorpia II. USS LAKE ERIE, USS SALVOR, USS PORT ROYAL, HAWTHORNE 5 & 8, USNS SUMNER, and SSV C-COMMANDO were involved in various aspects of the search and survey operation. Navy and Coast Guard aircraft were involved in the initial search and rescue operations. MDSU1, based in Hawaii, was responsible for the diving operations at the SWRS. Explosive Ordnance Disposal (EOD) Units Three and Eleven, and Ship Repair Facility (SRF) divers from Yokosuka, Japan, Naval Submarine Training Center Pacific, Dive School, Combat Camera Group, and divers from SALVOR participated in the dive operations.



Descriptions of these and other participating assets can be found in Appendix B: Mobilized Assets.

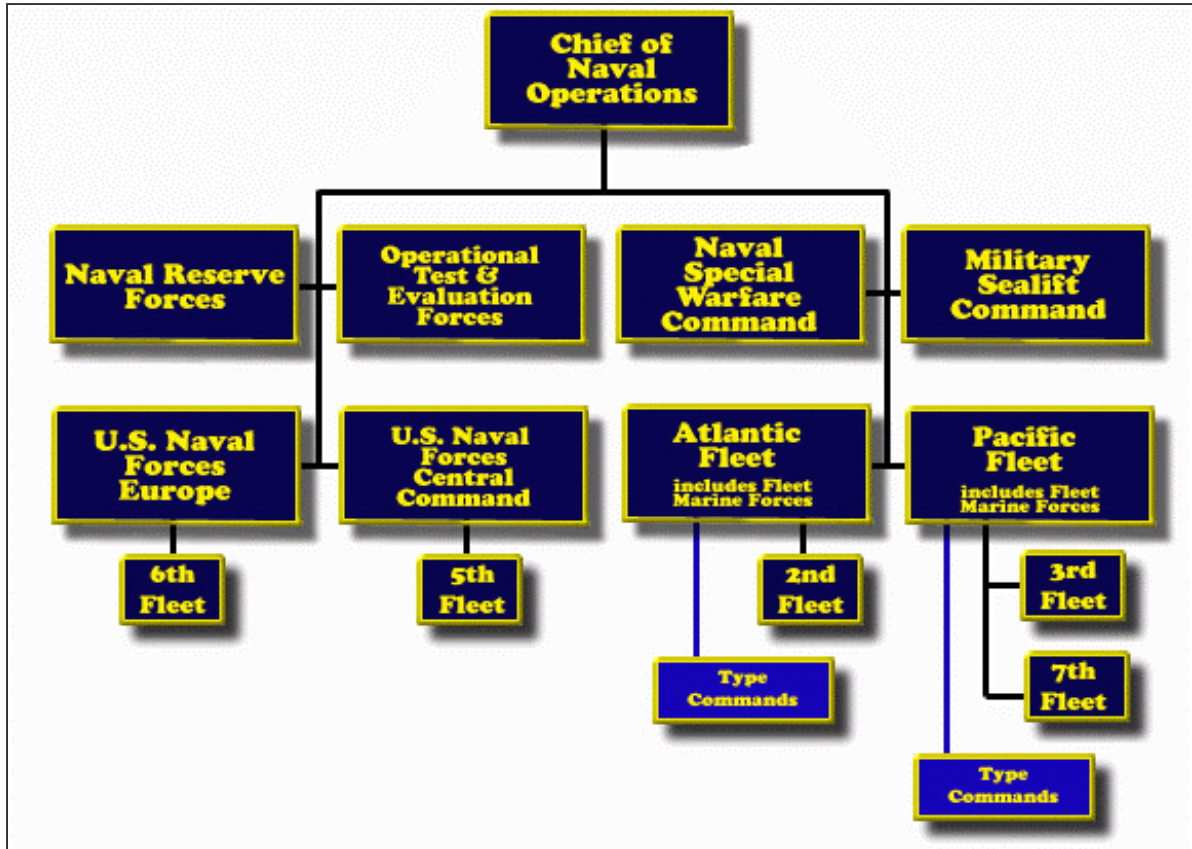

Figure 2-4. U.S. Naval Operating Forces Organization.

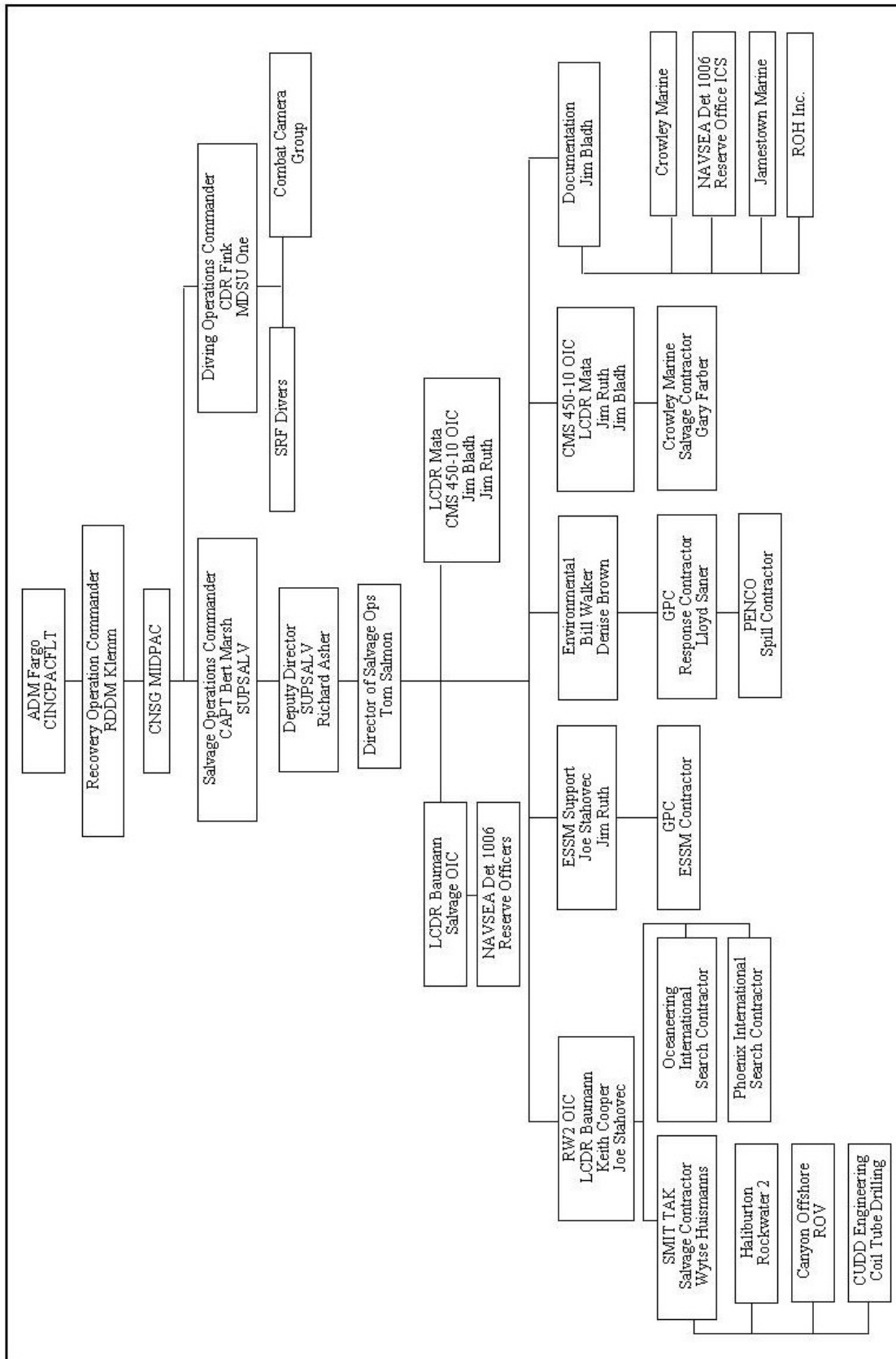

Figure 2-5. EHIME MARU U.S. Navy Command and Control.

## 2.3 Japanese Command and Organization

The Japanese Government, vessels, divers, and scientific community were integral to the planning and execution of the recovery and relocation of EHIME MARU. Despite the difficulty of the circumstances and the tremendous pressure both countries felt in making a timely decision about the recovery of the vessel, coordination and cooperation between the United States and Japan took place on multiple levels. Immediately following the accident, two Japanese training vessels, NIPPON MARU and HOKUHO MARU assisted with the search and rescue efforts.

There were repeated requests and understandable pressure from the Japanese government and relatives of those that were lost to raise the EHIME MARU and locate the nine missing personnel. The Chief Cabinet Secretary of Japan, Yasuo Fukuda, told U.S. officials that a technical and scientific committee was formed in Japan to help with any U.S. efforts to raise the ship. The committee consisted of hydrographers, oceanographers, and experts from Japanese shipbuilding and salvage companies. Beginning on February 16, 2001, the ROVs Scorpio II and Deep Drone and the SWISS Side Scan Sonar were on station gathering data and information in the area immediately surrounding the EHIME MARU. On February 20, 2001, relatives of the nine missing crewmembers were allowed to view video footage that showed all aspects of the ship and detected what appeared to be some of their relatives' belongings laying on the seabed around the vessel. These items included helmets, boots, bags, and other personal effects. All personal effects that were identified and located by the ROVs and side-scan sonar were recovered and returned to Japan, as requested.

On February 21, 2001 five Japanese salvage experts and scientists, and a representative from the Japanese Consulate met aboard USS SALVOR to discuss survey operations with the ROV Deep Drone. The group consisted of:

- Hiroshi Sato, Chief of Oceanography Office of Japan's Ministry of Foreign Affairs
- Keiichi Yokota, Office of the Secretary of the Cabinet
- Hiroyasu Monma, Ocean Science and Technology Center's Research Department
- Hiroyasu Takemoto, Ministry of Transportation's Laboratory of Shipping Technology
- Haruo Kawakami, Fukada Salvage Co. Ltd.
- Kouichi Shiota, Japanese Consulate Office, Honolulu

**F/V EHIME MARU Recovery and Relocation Report**

This group worked closely with SUPSALV in evaluating the feasibility assessment, providing valuable information on the construction of EHIME MARU and other technical data.

Throughout the remainder of the operation various Japanese vessels provided assistance in the survey and recovery of personal effects.

Figure 2-6 shows the multiple Japanese governmental and technical professionals involved in various aspects of the recovery effort.

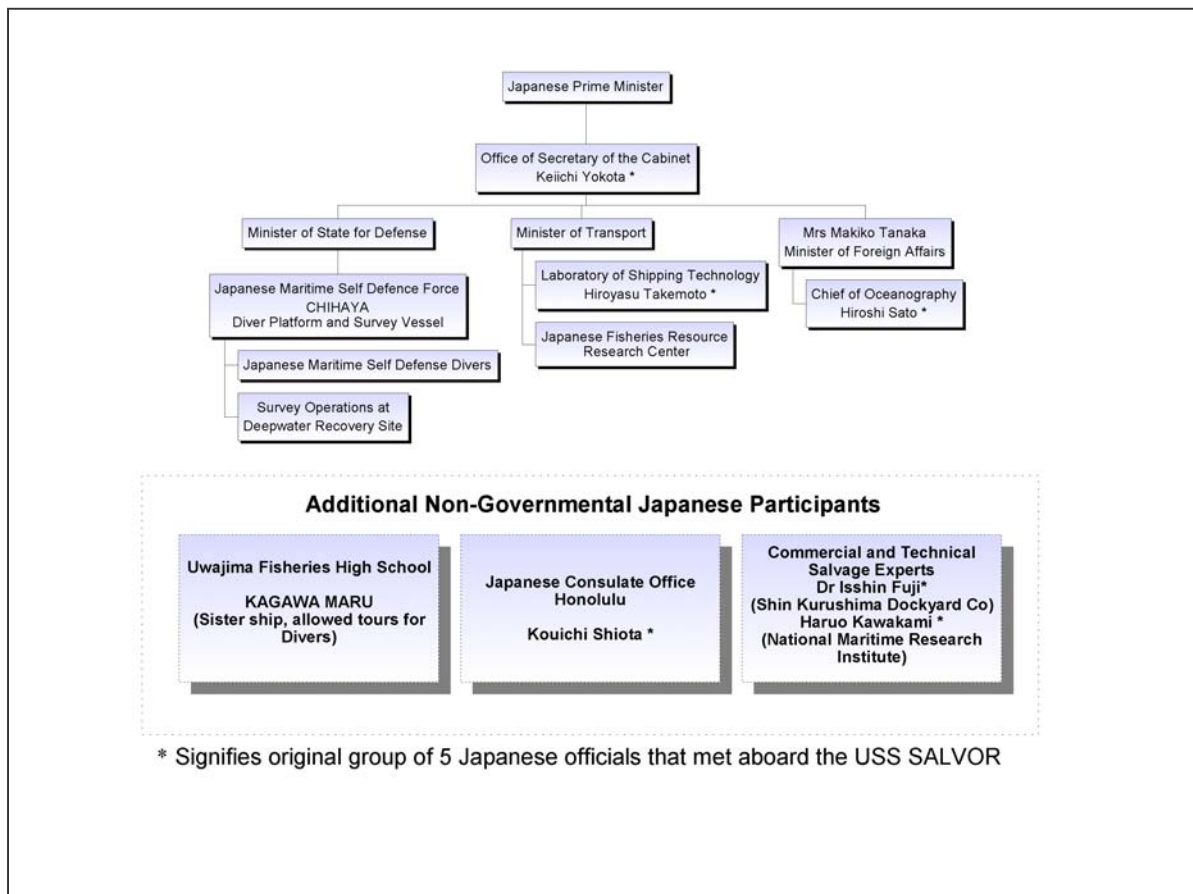

**Figure 2-6. Japanese Command and Organization.**

## *Chapter 3*

# **Public Affairs**

Immediately following the accident, CINCPACFLT assumed responsibility for public affairs. The CINCPACFLT Public Affairs office assembled a team that played a major role in every aspect of the operation. The number of personnel in the public affairs team fluctuated, but generally included six people. The team worked out of the EHIME MARU Command Center (EMCC) and CINCPACFLT Public Affairs Offices (PAO). Augmented by Navy Reserve personnel, the CINCPACFLT PAO team worked effectively with local, national, and international news organizations.

### **3.1 The Public Affairs Challenge**

It was clear from the onset that the recovery and relocation of the EHIME MARU would be highly visible and have political overtones. Sensitivities were high and relations between Japan and the United States were strained as a result of the accident. International media interest in the operation was high, especially in Japan and Europe. Public affairs challenges fell into three categories:

- The number of requests for information and the multiple time-zones of the requesting media
- Logistics concerning media space and accommodations
- Manpower shortages

During the EHIME MARU recovery operations the public affairs team responded to hundreds of local, regional, national, and international media requests, all with competing interests and deadlines. These requests come 24 hours a day from over 15 different time zones. This required dissemination of a large volume of information in a timely manner.

Logistical challenges arose in providing media workspaces, briefing areas, telephone lines, and parking areas to accommodate the satellite trucks and generators. Because of space limitations at Bishop Point, CINCPACFLT brought in a special barge that was set up with working spaces and a briefing room for the press. Access for the civilian media representatives to both Pearl Harbor Naval Base and Hickam Air Force Base presented additional challenges, particularly following the terrorist attacks on September 11, 2001. Although increased security made it difficult for the press to enter the military facilities, it was very important to the project to work with the security officers and resolve the problem.

Sufficient manpower to respond to the surge of media requests was an issue for the public affairs team. Naval reservists were called in to augment the active duty public affairs staff and provided invaluable assistance augmenting the CINCPACFLT PAO staff.

### 3.2 The EHIME MARU Recovery Website

CINCPACFLT set up two websites to facilitate distribution of information about the recovery and relocation of the vessel. The USS GREENEVILLE website was stood up February 11, 2001, two days after the accident. It covered the major events of the day with unrestricted access to the information. Local and international press organizations had access to the information and images posted on the website. The official EHIME MARU Recovery Effort website was stood up at the end of June 2001. It carried over from the USS GREENEVILLE website. The general public was provided updates on the operation via the website. They were also able to become familiar with the plans, environmental concerns, and operations in real-time. As an example, once the EHIME MARU was moved to the shallow water recovery site, airspace restrictions and marine safety zone information were provided on the website.

The U.S. Navy and Japanese participation in the recovery was highlighted in the event driven news articles. A total of 50 news events covering the period between February 16 and October 31, 2001 were included in the website. The website proved to be a very effective way of communicating and had a total of 6.7 million hits in its first year of existence. The website included:

- A chronology of past EHIME MARU news events
- Quick links to specific subjects
  - Airspace guidance
  - Safety zone reminder
  - Dive profile
  - USS GREENEVILLE news archive
  - USS GREENEVILLE image archive
  - Environmental assessment report
- Latest news
- Diver links
- USN images taken above and below water during the project
- Media event announcements
- Transcripts of interviews with RADM Klemm and CAPT Marsh
- Fact files
  - Alternate bow rigging
  - Recovery sites graphic
  - Rigging strategy presentation
  - ROCKWATER 2
  - Mobile Diving and Salvage Unit
  - JDS CHIHAYA



- ADM Fargo U.S. Pacific Fleet Commander
- RADM Klemm, Recovery Operational Commander

In addition to the CINCPACFLT EHIME MARU Recovery Effort website, detailed information about the search and rescue, recovery, and relocation of the EHIME MARU could be found on numerous other websites including websites from Japan, U.S. Coast Guard, participating organizations, academic, as well as local Honolulu newspapers. This report utilized information and graphics from the CINCPACFLT website and others previously mentioned. Some of the illustrations are courtesy of the Honolulu Advertiser.

### **3.3 News Briefings**

In order to better define the best way to provide coverage of the recovery operations the PAO team held several meetings with representatives from both the print and broadcast media from the United States and Japan. The meetings addressed various media needs and included a tour of the media barge prior to the media being brought onboard. The PAO team also anticipated a variety of media requirements that were defined during previous high visibility events. These requirements included:

- Frequent and timely news briefings
- Event driven news releases
- News conferences
- Media need for photos and video

There was no set schedule for media visits. They were done as the opportunity or need arose as events developed. One media event was scheduled aboard ROCKWATER 2. While the CMC 450 was being outfitted, there was a pier-side media event while the barge was pier-side. No media events were held aboard the dive barge during the dive operations. There was a media event scheduled aboard a contracted vessel that took media personnel out to the SWRS remaining a safe distance from the working barge.

Transcripts of five news briefings followed by questions and answers by RADM Klemm and CAPT Marsh occurred during the months of August, September, and October and were posted on the CINCPACFLT website. These news briefings were dictated by media needs and the events that unfolded. If the information to disseminate was particularly complex or there was an event that signified a major milestone, a press conference with one of the principals was scheduled. These transcripts helped the public and press to better understand the recovery operations.

## **F/V EHIME MARU Recovery and Relocation Report**

The photos and video were released through the EHIME MARU Recovery Operation Public Affairs Officer and distributed broadly. Fleet Imaging Command, Pacific combat camera divers provided the majority of the underwater photographs that came from the Shallow Water Recovery Site. The Remotely Operated Vehicles took all of the deep-water images.

## *Chapter 4*

# Planning and Management

The planning and management of the EHIME MARU operation was complex and multidisciplinary in nature. The planning team was an international, highly experienced mix of military, state and federal government, and private sector professionals. The U.S. Navy was in charge of the operation; however, the civilian and Japanese input was critical to its outcome. The success of the recovery operation was largely due to the ability of the planning team to accurately assess the situation, pull together the right assets and personnel to do the job, and communicate effectively. The Concept of Operations was shaped by four key reports and correspondence documents. These four documents reside in the appendices of this document. They include:

- EHIME MARU Salvage Feasibility Study (Correspondence from Commander, Naval Sea Systems Command to Commander and Chief Pacific Fleet dated: 21 March 2001)
- Engineering Analysis of the Feasibility of Salvaging the EHIME MARU (Correspondence from Commander, Naval Sea Systems Command to Commander and Chief Pacific Fleet dated: 21 March 2001)
- Plan for Recovery of the Remains of Crewmembers from the Japanese Fishing Vessel EHIME MARU (Correspondence from Commander, Naval Sea Systems Command to Commander in Chief, U.S. Pacific Fleet dated: 13 April 2001)
- EHIME MARU Environmental Assessment (15 June 2001) Executive Summary

Based on the Salvage Feasibility Study, Captain Marsh concluded it was technically feasible to raise EHIME MARU and estimated that there was an 80% chance of success. The Engineering Analysis defined the logic, calculations involved, and the steps required to raise the EHIME MARU. This study helped define an executable salvage plan based on a lift of the vessel, transit to the Shallow Water Recovery Site, and the recovery of crewmembers and their personal effects. The “Plan for Raising Fishing Vessel EHIME MARU to Allow Recovery of Crewmembers” was then written and laid the groundwork for the development of the Concept of Operations. The fourth report, the Environmental Assessment concluded that moving the vessel from its 2,000-foot depth to the 115-foot depth could be accomplished without significant risk to the environment. Based on that conclusion CINCPACFLT signed a “Finding of No Significant Impact” for moving the EHIME MARU from its current location to a mile off the shore at Honolulu airport.

## 4.1 Concept of Operations: Overview

The Concept of Operations was to utilize a commercial offshore construction ship, equipped with work-class ROVs and special lift systems, to relocate the hull of EHIME MARU from the DWRS to the SWRS. Divers would then search the hull and recover victims and personal effects. A commercial work barge would support the diving effort and then utilizing a ballast lift system, relocate the hull to the FRS, beyond the 1,000-fathom curve.

### 4.1.1 Identification and Mobilization of Support Organizations and Assets

Naval Sea Systems Command was tasked by CINCPACFLT to plan and conduct the recovery operations of the EHIME MARU and was responsible for the identification and mobilization of support personnel and assets.

Mobilization included the acquisition, charter, rent, manufacture, and movement of all equipment necessary to support the operations. The mobilization and project timeline covering the period of April 1 – October 31, 2001 was based on the availability of assets as well as scheduling the recovery and relocation activities during optimal weather conditions. The “Plan for Raising EHIME MARU to Allow for Recovery of Crew Members” prepared for NAVSEA includes a mobilization timeline. This timeline is shown in Figure 4-1.

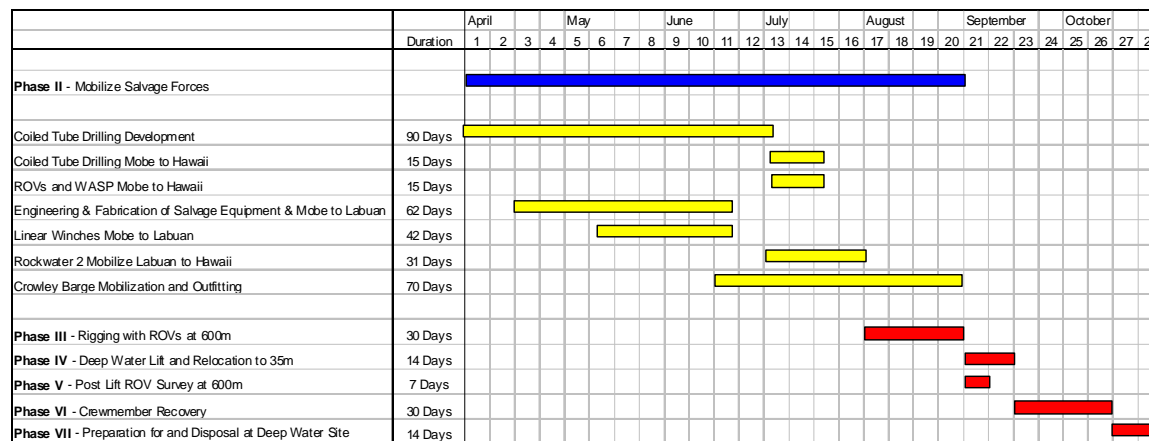

Figure 4-1. Initial Mobilization and Project Timeline.

The major equipment that was identified to perform the salvage operations included:

- Heavy lift vessel
- Ocean going barges and tugs
- Linear lift winches

- Coiled tube drilling system
- ROVs
- Precise deep ocean navigation system

SUPSALV maintains salvage contracts with several commercial salvage companies that provide the Navy with worldwide coverage to augment fleet resources. In this instance, the water depth and extreme weights involved exceeded the fleet's salvage capability. SUPSALV utilized the services of SMIT Salvage, Crowley Marine Services, Oceaneering International, Phoenix International, GPC, and ROH. SMIT and Crowley were the prime salvage companies, and responsible for the majority of the assets mobilized. SMIT chartered the offshore construction ship ROCKWATER 2 as the primary lift ship for the initial relocation of EHIME MARU. SMIT mobilized tons of equipment from Europe and Singapore to the Philippines where ROCKWATER 2 was outfitted for the operation. Crowley mobilized the CMC 450-10, an offshore construction barge from South America to Long Beach, CA for outfitting to support the dive and final relocation efforts.

SUPSALV, SMIT and Crowley put together a team from a multitude of organizations specializing in salvage operations and support services for the operation. Oceaneering and Phoenix provided search and survey teams to operate SUPSALV systems, GPC provided environmental support and the ESSM equipment and operators for the operation and ROH provided administrative and technical support.

Mobile Diving and Salvage Unit One, with some augmentation for the operation from the ESSM System, provided the diving systems. Because of the magnitude of the diving operation and the fact that they would be required to search every compartment on the ship, they used two complete dive suites. Some of the equipment was shipped from Long Beach on the CMC 450-10 and the CMS 250-6, a transport barge used throughout the operation for logistics.

Through the ESSM System, SUPSALV provided oil spill cleanup systems to support all phases of the operation. Most of the equipment was based in the ESSM Facility, Pearl Harbor, but some was shipped from Long Beach via the CMS 250-6.

The National Oceanographic and Atmospheric Administration (NOAA) provided significant assistance with USNS SUMNER, a ship generally used to map the sea floor to update and create navigational maps. Her specialized systems provided outstanding seafloor contour maps, current information through the water column, route maps, and other critical hydrographic information. This data was vital to the salvors when planning the lift and transport of EHIME MARU from the DWRS to the SWRS and the FRS.

**F/V EHIME MARU Recovery and Relocation Report**

The primary assets and responsible organizations in the recovery operations are included in Table 4-1.

<b>Table 4-1. CONOPS Activities, Assets, and Organizations.</b>				
<b>Activity</b>	<b>Organization</b>	<b>Asset Type</b>	<b>Asset Name</b>	<b>Employment</b>
Preparations for Lift and Transit	SMIT Salvage	Ship	OCEAN HERCULES	Prime WESTPAC salvage contractor for SUPSALV. Cleared debris, cleared center and forward masts, support vessel for ROV Phoenix III
	USN	Ship	USS SALVOR ARS 52	Involved in all activities, Primary platform for operating SWISS Side Scan Sonar and DEEP DRONE
	USN, Military Sealift Command, Far East	Ship	USNS SUMNER T-AGS 61	Hydrographic (multi-beam survey) Survey of wreck site
	Clean Islands	Ship	OSRV CLEAN ISLANDS	In standby and responding to any and all spills and sheens.
	USN, Military Sealift Command	Ship	C-COMMANDO SSV	Support Vessel for SCORPIO II
	USCG	Patrol Boat	Various	Patrolling entire operation to keep on-lookers away
	USCG	SAFETY Zone Enforcement Craft	Various	Providing security throughout the operation
	USCG	Helicopter	HH-65	Standby the entire operation, also utilized for oil sheen tracking
	USN, SUPSALV Emergency Ships Salvage Material System ESSM	Salvage and Oil Spill Equipment	Various	Provided oil spill abatement and salvage equipment throughout the recovery efforts
	USN, SUPSALV ESSM	Skimmer	USN SKIMMER	On standby for entire operation to respond to oil leaks
	GPC, SMIT*	Helo	KTR Helo	
	Oceaneering International Inc.	ROV	PHOENIX III	Subcontractor to SMIT. Cleared deck of all cargo nets and other obstacles
	Canyon Offshore	ROV	XL-16	Subcontractor to SMIT. Rigging at DWRS
	Canyon Offshore	ROV	QUEST	Subcontractor to SMIT. Rigging at DWRS
	USN SUPSALV	ROV	DEEP DRONE	Surveyed bottom surrounding EHIME MARU DWRS along with the ROV SCORPIO II for debris and personal effects, provided visual images of damaged ship
USN, SUBDEVRON, Deep Submergence Unit	ROV	SCORPIO II	Located EHIME MARU and provided original videos to determine ships condition, surveyed wreckage area for identification debris field	
Canyon Offshore	ROV	MANTA	Subcontractor to SMIT. Close up video and observation support during rigging	



<b>Table 4-1. CONOPS Activities, Assets, and Organizations (continued).</b>				
<b>Activity</b>	<b>Organization</b>	<b>Asset Type</b>	<b>Asset Name</b>	<b>Employment</b>
Lift and Relocate	Haliburton Subsea	Ship	ROCKWATER 2	Subcontractor to SMIT. Host work platform, Lift and transport vessel. Platform for 3 ROVs,
	Crowley Marine Services	Tug	Sea Valor	Prime Eastern Pacific salvage contractor to SUPSALV. Support and transport vessel. Towed Crowley Barge 450-10.
	Crowley Marine Services	Tug	Sea Cloud	Prime Eastern Pacific salvage contractor to SUPSALV. Support and transport vessel. Towed Crowley Barge 250-6.
	Crowley Marine Services	Barge	Barge 250-6	Prime Eastern Pacific salvage contractor to SUPSALV. Support barge
	USN, Military Sealift Command, Far East (operated by Dyne Marine Services)	Ship	USNS SUMNER T-AGS 61	Lead escort ship from DWRS to SWRS providing real-time depth, current, wind and wave data along route
	USN, SUPSALV Emergency Ships Salvage System		Containment booms, skimmers, sorbent material, oil transfer pumps and hoses etc (see Section 4.1.2)	Provided oil pollution abatement equipment to support the recovery operations
	Japanese Maritime Defense Force	Ship	CHIHAYA ARS 403	Survey DWRS once the EHIME MARU was re-located
	Japanese Ministry of Education and Science	Ship	Support vessel for KAIKO	Bottom search and grid survey of Deep-water Recovery Site
	Japanese Marine Science and Technology Center	ROV	KAIKO	Bottom search and grid survey of Deep-water Recovery Site
	Sandstone Helicopters	Helicopter		Subcontractor to SMIT and Crowley. Transit workers to and from Crowley 450 barge?
	USCG	Fixed Win and Helicopter Aircraft		Overflights during the lift and relocation
		SUPSALV	Oil Skimmers	Various
Recovery	Japanese Maritime Defense Force	Ship	CHIHAYA ARS 403	Platform and Support Vessel for Japanese Maritime Defense Force Divers
	Uwajima Fisheries High School	Ship	KAGAWA MARU (sister ship of EHIME MARU)	Toured by USN divers for familiarization prior to the surface supply dive operations
	Crowley Marine Services	Barge	CMC 450-10 Accommodation Work Barge	Prime Eastern Pacific salvage contractor to SUPSALV. Platform for U.S. Navy Surface Divers

Table 4-1. CONOPS Activities, Assets, and Organizations (continued).				
Activity	Organization	Asset Type	Asset Name	Employment
Recovery	USN	Helicopter	HSL-37 Helicopter Anti-Submarine Line 37	Participated in initial SAR and later in Security and oil spill identification
	Crowley Marine Services	Supply boat	SEA VALOR	Prime Eastern Pacific salvage contractor to SUPSALV. Logistical Supply runs every Friday for CMC 450-10. Performing twice daily security checks using DGPS to monitor the position of the crown buoys and barge.
	U.S. Navy	Comms		EMCC
	U.S. Navy	Divers	MDSU One SRF Yokosuka USN Submarine Training Center, Pacific USS SALVOR Explosive Ordnance Disposal 3 Explosive Ordnance Disposal 11 Combat Camera	Victim and victim personal effects recovery, video survey
	Japanese Maritime Self Defense Force	Divers	Japanese and Japanese Maritime Self Defense Force	Victim and victim personal effects recovery
	U.S. Army, 68 <sup>th</sup> Army medical helo	Helo		On standby to transport in case in injury
Relocation to Deep-Water Site	Crowley Marine Services	Barge	CMC 450-10 Accommodation Work Barge	Prime Eastern Pacific salvage contractor to SUPSALV. Lifted EHIME MARU (by ballasting down and up) and transported the EHIME MARU to the deep-water disposal site

#### 4.1.2 Special Considerations

The Environmental Assessment Report (which was located on the CINCPACFLT EHIME MARU Recovery website) provided a detailed analysis of various recovery plans and their potential impact on the surrounding environment. Special considerations and consequences were identified for each recovery alternative in the event of an oil spill. Water quality, marine biological resources, health and safety issues, hazardous material and hazardous waste, and their air space regions of influence were all addressed for the proposed alternatives. In addition, items such as agency support, mitigation measures, incident action plan, oceanographic parameters, plume models, and sea-state limitations were all discussed in detail in this report.

### 4.1.2.1 Airspace Management

Managing airspace use was a special consideration throughout the recovery operations. Daylight over-flight operations took place during various phases of the recovery efforts for oil spill detection. The local civilian and military flight operations were effected by the recovery efforts. The terms, Region of Influence, Controlled and Uncontrolled Airspace, and Enroute Airways were used to describe the flight restrictions in the various locations. The Region of Influence (ROI) is defined as the airspace within and below the 20 nautical-mile radius Class B Airspace associated with Honolulu International Airport on and off the south coast of Oahu. “Class B airspace is generally that airspace surrounding the nation’s busiest airports in terms of instrument flight rules operations or passenger volume. An air traffic control clearance is required for all aircraft to operate in the area and all aircraft that are so cleared receive separations services within the airspace.”

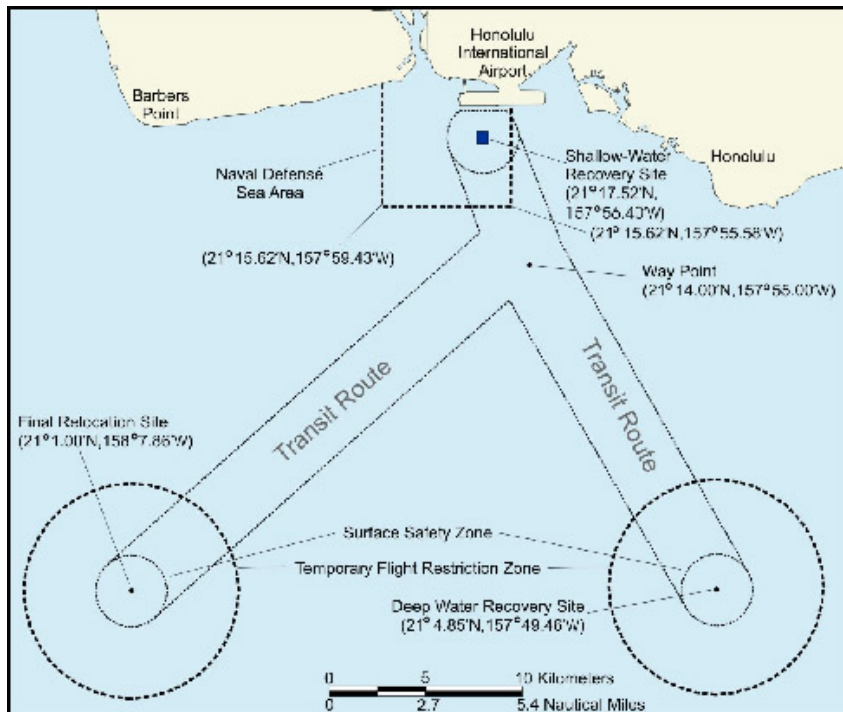

Figure 4-2. Transit Routes for EHIME MARU.

The general ROI encompassed the Deep Water Recovery Site, the Shallow Water Recovery Site the Final Relocation Site, and the transit routes between each site. There were special instructions and restrictions for pilots during the EHIME MARU recovery operations that were identified and enforced by the FAA. The restrictions are described in Table 4-2.

Table 4-2. Airspace Management.			
Vessel Location	Region of Influence (ROI)	Controlled/Uncontrolled Airspace	Enroute Airways
Deep-Water Recovery Site	3 nm radius	<i>Uncontrolled airspace</i> from surface to 700 feet above sea level, and controlled airspace above that. Pilots are required to remain at least 1,000 feet above the highest obstacle within a horizontal distance of 4 nm <i>Controlled airspace</i> - no specific arrival or through flight entry requirements.	Two low altitude enroute airways entered and transect the ROI
Transit Route to the Shallow-Water Recovery Site	3 nm radius	This lays under two separate layers of Class B airspace, with two distinct altitude floors, Between DWRS and 5 miles from Honolulu Airport; the layer has a floor of 1,500 feet above sea level. Lying under this is another layer of controlled airspace and a layer of uncontrolled airspace from the surface to 700 feet	One low altitude airway lies to the east of the transit route to the shallow-water recovery site. Another airway lies to the west of the transit route
Shallow-Water Recovery Site	3 nm radius	This lies under the “core” Class B airspace surrounding Honolulu Airport. The ceiling is 9,000 feet above sea level and extends to the surface.	No enroute low altitude airways within airspace above the SWRS. Arriving aircraft move from the network of airways serving aircraft operations to start their final approach. This is close to but well below the approach zone of one runway
Deep-Water Relocation Site	3 nm radius	Controlled airspace is 1,500 feet above sea level	There is one low altitude enroute airway in this vicinity

#### 4.1.2.2 Environmental Protection

Due to the high environmental sensitivity and economic value of Hawaiian waters and shoreline, an Environmental Protection Plan was developed by GPC, and was integral to the Concept of Operations. The purpose of the plan was to identify and minimize the level of environmental risk during the following salvage operations:

- Preparation for Lift and Transit
- Lift and Relocate
- Shallow Water Operations
- Transit to Final Relocation Site

Table 4-3 outlines the risk associated with each phase of the relocation operation and the spill response capability defined in the environmental protection plan.

<b>Table 4-3. Response Phases, Spill Risks, and Standby Spill Response Capability.</b>		
<b>Phase</b>	<b>Risk</b>	<b>Spill Response Capability</b>
Preparation for Lift and Transit	Low	Periodic surveillance overflights 1 Vessel-mounted dispersant spray system on site 2 skimmer systems ready standby at Pearl Harbor 2 Helicopter Dispersant Buckets ready standby in Honolulu Full logistic support and standby relief crews
Lift & Relocate	Moderate	Frequent surveillance overflights 1 Vessel-mounted dispersant spray system on site 1 Skimmer System fully operational standby on site 2 <sup>nd</sup> skimmer system standby at Pearl Harbor & meet vessel @ 3 miles 2 Helicopter dispersant bucket system ready standby in Honolulu Full logistic support & standby relief crews
Shallow-Water Operations	Low	Periodic surveillance overflights 1 Vessel-mounted dispersant spray system on site 2 Skimmer System fully operational on site during lift 2 Helicopter dispersant bucket systems ready standby in Honolulu Optional considerations (two tow boats with wide sweep boom) Full logistic support and standby relief crews
Transit to Final Relocation Site	Low	Periodic surveillance overflights 1 Skimmer system accompany vessel to 10 miles offshore 2 <sup>nd</sup> Skimmer system ready standby at Pearl Harbor 2 Helicopter dispersant bucket systems ready standby in Honolulu Full logistic support and standby relief crews

EHIME MARU was loaded with 65,000 gallons of diesel fuel; 1,200 gallons of lube oil and a small amount of kerosene at the time of the accident. There was an obvious sheen where the ship went down, but there was no way to know how much of the fuel remained on board. The possibility of releasing any or all of the remaining hazardous materials during the recovery and relocation operations was a significant consideration that had to be included in the overall salvage plan. Factored into the planning and CONOPS of the EHIME MARU recovery operations was the availability of oil spill and salvage equipment provided by local hazardous materials response organizations. The two main organizations, local to Hawaii, that provided their multiple oil spill and salvage capabilities were the SUPSALV Emergency Ship Salvage Material (ESSM) facility, Pearl Harbor and the Clean Islands Council.

**ESSM**

The local ESSM facility, which falls under the operational control of SUPSALV, is located at Bishop Point, adjacent to Hickam Air Force Base. SUPSALV maintains a significant inventory of salvage and oil pollution abatement equipment in ESSM facilities around the world. GPC, the contractor that maintains the ESSM system played a significant role in developing contingency plans for clean up of oil spills, and identifying and providing oil pollution and various salvage equipment.

## F/V EHIME MARU Recovery and Relocation Report

The equipment made available to the EHIME MARU recovery operations by ESSM is listed in Table 4-4.

<b>Released Oil Recovery</b>	<b>Casualty Off-Loading</b>	<b>Ancillary Support Equipment</b>
Containment booms	Oil transfer pumps and hoses	Personnel support vans
Open-ocean skimmers	Floating hose systems	Maintenance vans
Small skimmers	Hot tap systems	Support vessels and small boats
In-situ burning equipment	Portable generators	Cleaning equipment
Sorbent materials	Portable fire fighting pumps	Command vans
Vacuum recovery systems	Hydraulic power packs	Communication systems
Floating storage bladders	Salvage equipment (various)	Material handling equipment

### Clean Islands Council

Clean Islands Council is a consortium of regular and associated members working together with the entire Hawaii community to foster, train, and demonstrate safe work practices related to responding to an oil spill. The Clean Islands Council provided an ocean-capable Oil Spill Response Vessel during the operation. This vessel was equipped to collect spills in typical ocean sea states. Other oil spill abatement resources made available to the EHIME MARU project by Clean Island Council can be found in Table 4-5.

<b>SKIMMERS</b>	<b>PUMPS, SKIMMER ACCESSORIES</b>	<b>CONTAIN- MENT</b>	<b>BOOM</b>	<b>VESSELS AND SKIFFS</b>	<b>PACKAGES</b>
Diesel Powered Peristaltic Hose Pump w/ Skim Pack 4200 package with hoses (3)	Pneumatic double diaphragm pump w/hose (3)	20,000 gallon storage bladder (4)	Spectrum Trailer with 1,000 foot 8" by 12" Acme boom (3)	10' under pier skiff w/ oars	Large personnel zone control/decon station (3)
Oela Four Float Weir Skimmers (3)	Gas single diaphragm pump	5 cubic meter Ro-Tank Temporary Storage Bladder	1,800 ' of 42" Expandi boom	9' under pier skiff w/oars	Large fishtote workvest pack 50 sets (2)
GT 185 Ocean Skimmer with ASI 16TSO Power Pack, hoses w/Hyd. control table (2)	Karcher Steam pressure washer	2,500 gallon fast tanks (4)	180 feet of 42" trail boom	8' under pier skiff w/paddle	PPE Overpak 50 sets (3)
Mini Walosep	Acme floating circulation pump		100 feet of 44" trail boom	24' pontoon boat with O/B	Arge heat stress shade station (2)
Slickbar Slurp Weir	Acme floating washdown pump			17' boom boat with O/B	Multi person hand washing basin
Oil Mop OMI 1-4D				15' Boston Whaler with O/B	Foss 25 by 50 foot large decon pool
Oil Mop OMI 11-4D Trailer Mounted				15' fiberglass under pier boat with O/B	Small personnel decon station
Oil Mop OMI 11-9D					Shoreline cleanup tools package
Aquaguard Rbs-10 Brush/Disc.Drum skimmer with 24-foot Aqua Cat Vessel					Versitek API separator (4)
Lori 4 Brush Side Mounted Skimmer with DOP 250 pump package					Skid mounted fiberglass 2500 gallon API separator
					Diesel powered light trailer

#### **4.1.2.3 Real-Time Winds, Currents, and 3-D Hydrography**

As the plan developed to raise EHIME MARU from the ocean floor and transport the vessel in the water column below ROCKWATER 2, a specific list of critical parameters were identified regarding vessel speed and acceptable marine weather conditions (winds, currents, and swells). The goal was to transport the vessel without making contact with submerged features, breaking the lifting apparatus, losing the vessel, or creating an oil spill. In order to successfully relocate the vessel, the operators relied on precise hydrographic

information, bottom contouring, and substrate collection and analysis as well as real-time marine weather information displays in order to make critical operational decisions in both the planning phases and operational phases of the relocation.

In the event of an oil spill, the real-time current and wind information would be used as input to the oil spill model, providing trajectory information. In addition, the Hazardous Materials Response Division of NOAA used historical tide, current, and wind information, as well as hydrographic data as input to oil spill trajectory models, providing a series of oil plume trajectory analyses (refer to Appendix H: Plume Model, Environmental Assessment Report). These modeling efforts provided information to operational planners about the behavior of an uncontained diesel fuel release at the Shallow Water Recovery Site. The plume models provided information about where the fuel would travel, given specific wind and current conditions.

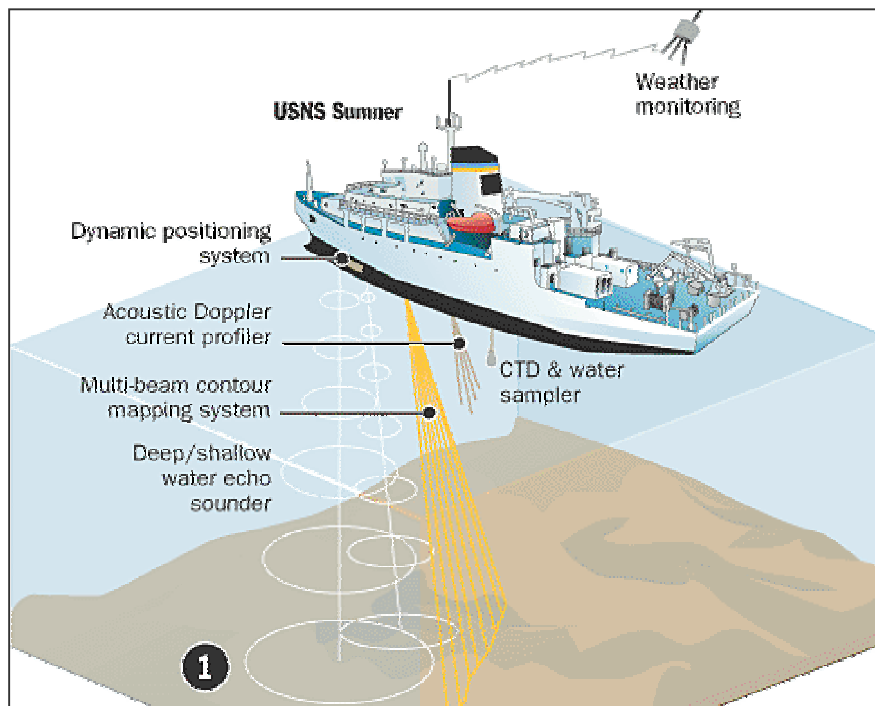

**Figure 4-3. USNS SUMNER.**

USNS SUMNER, shown in Figure 4-3, a Military Sealift Command oceanographic survey ship operated by Dyn Marine Services, conducted a detailed hydrographic survey of the 14-mile route from the Deep Water Recovery Site to the Shallow Water Recovery Site. During the relocation of EHIME MARU, the hydrographic data was transformed into a three-dimensional image of the subsurface that was displayed aboard ROCKWATER 2. This allowed the crew on ROCKWATER 2 to anticipate peaks in the bottom contour requiring raising and lowering EHIME MARU as she transited from one location to the



other. SUMNER deployed current meters, a Texas Automated Buoy System, collected ocean sediment samples and took conductivity/temperature/depth measurements prior to the operation for background information to aid in the operational decisions.

SUMNER made multiple passes over the transit route to ensure accuracy and detailed coverage of the ocean floor. The current meter arrays were deployed and retrieved prior to the transit and data was collected from additional conductivity /temperature/depth measuring equipment. In addition, SUMNER utilized its Acoustic Doppler Profiler Transducer to measure real-time currents from the surface of the water to the ocean floor during the transit.

During the relocation of EHIME MARU, SUMNER maintained a distance of .25 nautical miles from ROCKWATER 2. In order to prevent undue stress on the vessel and lifting equipment, the average speed maintained was approximately 0.8 knots. There were frequent stops along the way to allow for raising and lowering the vessel in the water column. Precise navigation and tracking of the currents and winds was essential for safe and successful operations.



**Figure 4-4. Personnel Aboard USNS SUMNER.**

Figure 4-4 shows crewmembers preparing oceanographic data collection equipment for the EHIME MARU project. Twice daily forecasts and nowcasts were disseminated via AUTODIN, fleet broadcast and the website. The EA and Findings of No Significant Impact established METOC thresholds. These thresholds are defined in the METOC message traffic located in Appendix E: Correspondence.

#### **4.1.2.4 Remote Visualization and Management Tools for Underwater Operations**

Operating in the deep ocean environment with multiple platforms presents a multitude of challenges due to the nature of working remotely with multiple cables and wire ropes suspended beneath the ship and the limited field of view of the ROV cameras. Transporting a vessel in the water column also creates a vulnerability that necessitates full awareness of the working environment both before and during the transit. Computer models and sophisticated geographic information displays aided significantly in the management of remote work systems. During the EHIME MARU relocation, the Recovery Operational Commander had access to computer models that provided virtual images of the ROVs working alongside EHIME MARU in real time, oil spill models for contingency planning purposes, and 3-D hydrographic imagery for underwater navigational decisions. (See Section 5.4 for details on data visualization)

#### **4.1.3 Information Exchange**

Effective and efficient communications played a large role in the success of the Command and Control of the project. Since both military and civilian assets were involved in all phases of the operations, the communications methods involved both military and civilian equipment. The vessels involved in the recovery and relocation operations utilized a variety of communication methods including, but not limited to bridge-to-bridge VHF, INMARSAT, SATCOM, UHF, both UHF and VHF hand held communications, as well as e-mail. Cell phones were commonly used among the operational participants. Because cellular telephone conversations are easily intercepted, some sensitive communications were made on more secure systems. Vigilance was required by the operational participants to assure that they were not allowing inaccurate or inappropriate information to be shared with the public.

Figure 4-5 is an example of an operational communication grid that depicts the number of participants and the methods of communication used during the recovery phase of the project.

	BRIDGE TO BRIDGE VHF	INMARSAT	CELL PHONE	E-MAIL	LAND LINE	SABER	IRIDIUM	SATCOM UHF	VHF KY97A	LONG RANGE VHF	INTERNET ACCESS
EMCC	■		■	■				■		■	■
USS SALVOR	■	■	■		■		■	■			
HSL 37	■				■						
TWR	■	■	■	■	■						
USCG PB	■										
USCG HELO	■				■						
MDSU 450	■		■			■		■		■	
USN SKIMMER	■										
NAVSEA KTR HELO	■										
OSRV CLEAN ISLAND	■		■	■	■		■		■		■
68 <sup>TH</sup> ARMY MED HELO					■						
JDS CHIHAYA	■	■	■	■							
SECURITY BOAT	■		■								

Figure 4-5. EHIME MARU Operational Communication Grid.

#### 4.1.4 Operational Logistics

COMNAVSURFGRU MIDPAC was assigned as Logistical Commander responsible for developing logistics plans and tasks. These tasks included providing:

- Temporary pier space for contractor barges and tugs, sewage and oily waste transfer and disposal
- Periodic water taxi service
- Logistics support for anticipated and unanticipated releases during each phase of the recovery operation
- Disposal of all recovered oily waste, solid waste and hazardous material
- Handling of oiled wildlife as needed
- Decontamination services as needed
- Daily logistics services to Crowley 450-10 barge
- Transfer of personal effects from Crowley Barge 450-10
- Arrangements for fueling, maintenance, and repair of vessel resources
- Tracking mechanism and recording all incremental costs.

## **F/V EHIME MARU Recovery and Relocation Report**

The EHIME MARU recovery and relocation project was unique in that it did not require a substantial shore-based logistics support facility. Some of the items that were brought to the surface included the debris on the decks, the anchors and chain, and the mast, that were removed prior to the relocation. During the recovery operations, a large amount of debris was removed from the ship in order to clear the passageways before searching the compartments. This removed material was staged nearby on a military base.

Several entities and organizations that were involved in the operations needed daily logistical support. The prime contractors and various sub-contractors provided daily information to their project managers. This information was forwarded to the Recovery Operational Commander. This kept all personnel informed of the daily activities, problems, supply issues, and personnel changes and provided the Logistical Commander the information needed to handle the logistics of moving equipment, and feeding and transporting personnel involved in the project.

The prime support contractors each had a logistics coordinator on shore to handle urgent requirements available from the commercial sector. Daily Status Reports from SMIT and Crowley included items such as:

- Vessels on Location
- Personnel Onboard (including personnel from multiple companies)
- Equipment Onboard
- Summary of Activities
- Weather on Location
- Project Daily Progress (time noted for each event)
- Planned Activities in Next 24 hours
- Safety Report
- Areas of Concern
- Client Remarks
- Logistics Requirements

SITREP feeders from SUPSALV representatives were submitted daily via e-mail to the EMCC in order to keep the Operational Commanders informed. The SITREP feeder generally included the following sections:

- Operations
- Tasks Completed
- Problems Encountered
- Equipment Casualties
- Future Intentions

- Public Affairs Inquiries
- OIC Comments
- Weather

The Logistical Commander operated out of the EMCC and worked closely with the salvage contractors and MDSU to ensure that all required USN support was readily available.

## 4.2 Management

For an operation of this magnitude, a shore based command center is required to manage all of the logistical issues, control multiple offshore assets, maintain relations with the media, etc. In this instance, a logical space for the EHIME MARU Command Center (EMCC) was available in the ESSM facility. A large room existed that was designed as command center for oil spill response operations. It included sufficient space for all of the conference tables, computers, phones, radios, video systems, and admin support equipment to support the staff Admiral Klemm organized. A desk was set up for each of the support groups (salvage, PAO, environmental, logistics, etc.) allowing them to work independently, yet interact easily with other members of the staff.

The offshore operations were managed by SUPSALV during the salvage phases and by MDSU 1 during the diving phase. The offshore teams reported daily or as required to keep the EMCC current with progress.

Oil spill response systems were on standby at all times. When deemed necessary, skimmers and support craft deployed to the DWRS or SWRS to conduct clean up operations if required. By using assets based in the ESSM facility, located at the entrance to Pearl Harbor, rapid access to sea was assured.

Reserve salvage officers were used to man offshore communication systems to report operational status. This was an excellent use of reserves and relieved the salvage crew from having to dedicate one of their personnel to the task. During routine conditions reports were submitted daily. When critical operations were underway, reports were made more frequently. Having reserves dedicated to this task ensured that there would always be an open communications link.

Data management was accomplished by using Microsoft Project software. Once the database was set up, each of the management teams updated their status electronically, and one of the staff officers consolidated the inputs into the main database. This was an excellent way to clearly show operational status in near real time.

## **F/V EHIME MARU Recovery and Relocation Report**

During the initial planning for the operation, SUPSALV provided CINCPACFLT with an estimated cost, based on rough estimates. While the ultimate cost of the operation was significantly higher, the initial estimate allowed decision makers to know that they were embarking on a very expensive operation. CINCPACFLT directed all participating organizations to track all costs and report the totals for potential reimbursement following the operation. Because of the major involvement of commercial resources, NAVSEA was required to fund the majority of the operational costs. Mr. Richard Asher, Deputy Director for SUPSALV, worked with the NAVSEA Comptroller to ensure that contracted efforts were funded as needed. The CINCPACFLT Comptroller worked closely with SUPSALV to ensure that the overall costs were constantly monitored and reported to RADM Klemm and CINCPACFLT.

## *Chapter 5*

# Recovery Operations

Chapter 5, Recovery Operations, discusses the eight phases of the recovery and relocation of EHIME MARU, beginning with Phase 0, the Search and Feasibility Study, and ending with Phase 7, the Preparation for Relocation at Deep Water Site.

### 5.1 Phase 0 – Search and Feasibility Study

The first phase of this operation was to locate and survey EHIME MARU and collect information to determine the feasibility of recovering the missing crewmembers.

The Navy's Deep Submergence Unit (DSU), assigned to COMSUBDEVRON FIVE, conducted the initial search with the ROV SCORPIO II (Figure 5-1) from the vessel C-COMMANDO. Using an onboard sonar and video system, SCORPIO II located EHIME MARU on February 16th sitting nearly upright in 2,000 feet of water.



**Figure 5-1. The ROV SCORPIO II Operated by DSU Located EHIME MARU on February 16 From the Vessel C-COMMANDO.**

A more extensive underwater search was conducted by the SUPSALV Shallow Water Intermediate Search System (SWISS) embarked on USS SALVOR (ARS 52), Figure 5-2.

## F/V EHIME MARU Recovery and Relocation Report

The SWISS (Figure 5-3) is a dual frequency towed sonar system mounted in a torpedo shaped tow body. The sonar is towed behind a vessel at slow speeds, generally between one and five knots. The images from SWISS helped in locating objects on the bottom and to identify bottom features surrounding EHIME MARU. This information aided in the Feasibility Study and the Recovery Plan.

The sonar search area was a rectangle of approximately 2 nautical miles by 3 nautical miles. The SWISS data confirmed that EHIME MARU was within 1,000 yards of the collision point. A geographically large search area was established in order to be confident that any major items from EHIME MARU that may have broken away during the accident would be located. Figure 5-4 represents a search grid that was used in the EHIME MARU recovery operations. Figure 5-5 is a sonar image of the hull as it was found on the sea floor.

ROVs were employed to survey EHIME MARU after she was located. In addition to DSU's SCORPIO II, SUPSALV mobilized the ROV Deep Drone aboard SALVOR. Both systems conducted an extensive video survey of the outside of the vessel that would be used by salvage engineers to assess the feasibility of the operation, estimate the remaining hull integrity and develop the salvage plan. Figure 5-6 provided visual confirmation that the hull was EHIME MARU.



**Figure 5-2. USS SALVOR (ARS 52).**



**Figure 5-3. Shallow Water Intermediate Search System (SWISS).**



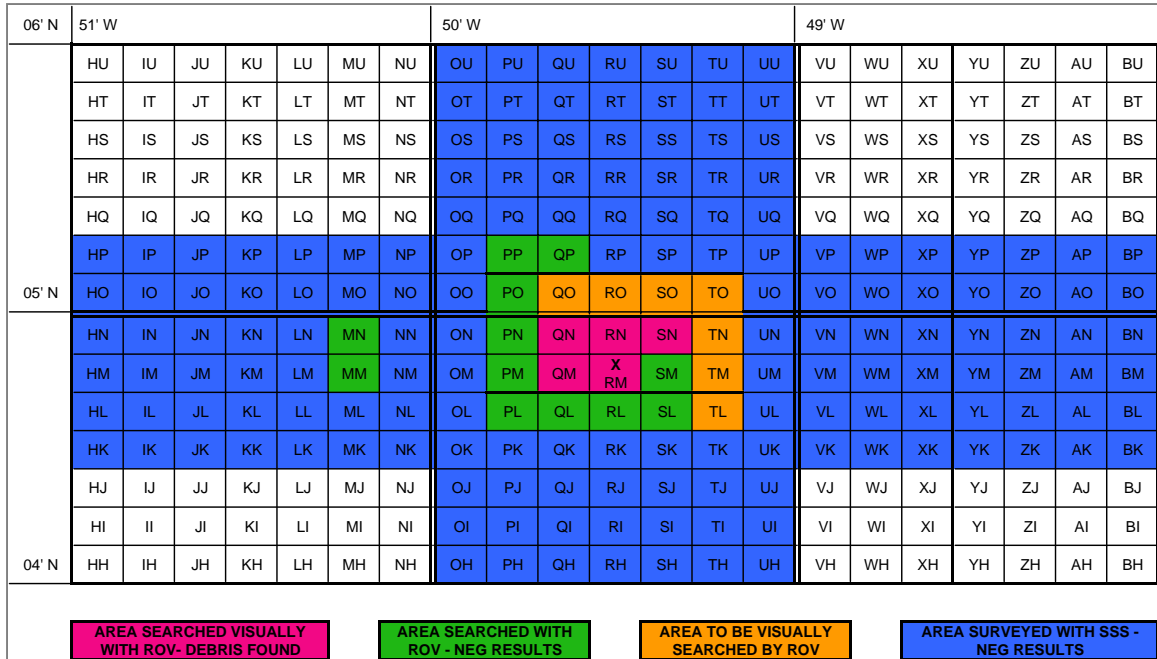

Figure 5-4. Search Grid Used for the Side Scan Sonar Search Centered Around the Located Position of EHIME MARU.

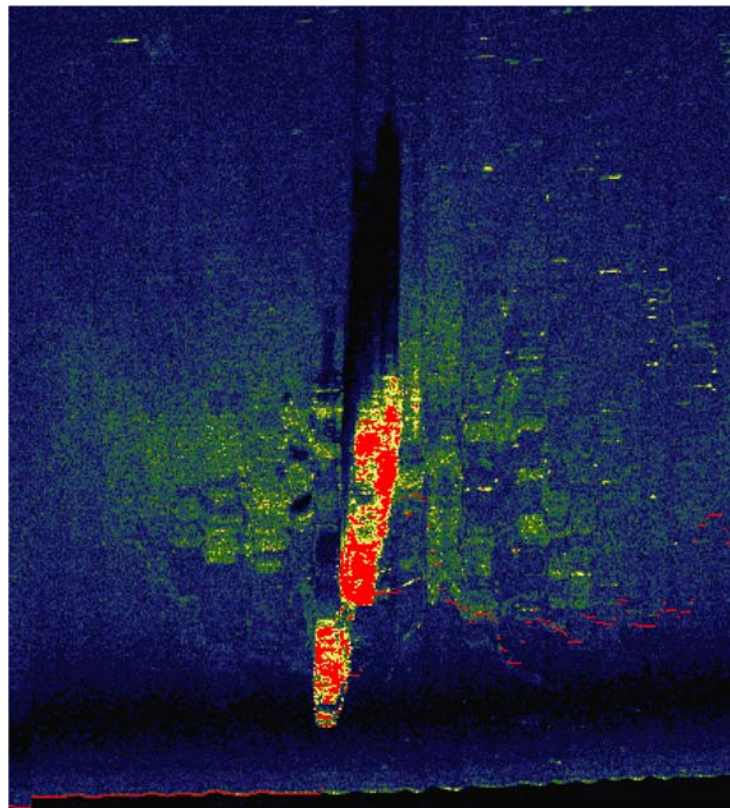

Figure 5-5. SWISS Side-Scan Sonar Image of EHIME MARU.



Figure 5-6. Stern of EHIME MARU.

EHIME MARU was sitting upright on the seafloor and had significant external hull damage. The most obvious exterior damage was buckling in the forward port and starboard shell plating. In addition, because of the rapid sinking of EHIME MARU, and since the bottom of the vessel was not visible, experts suspected that a hole with an area of approximately 108 square feet (10 square meters) existed in the bottom of the hull. It was also assumed that major watertight bulkheads were damaged by GREENEVILLE's rudder, which allowed rapid flooding of EHIME MARU. Other obvious damage included bending of the forward mast to port and minor shell plate buckling at the stern and bow. EHIME MARU sat with the stern buried up to 6 feet in the sandy bottom with just the top of the rudder visible. Figures 5-7 and 5-8 are drawings showing where visible damage was found on the hull. Figures 5-9 and 5-10 are video images of the damage.

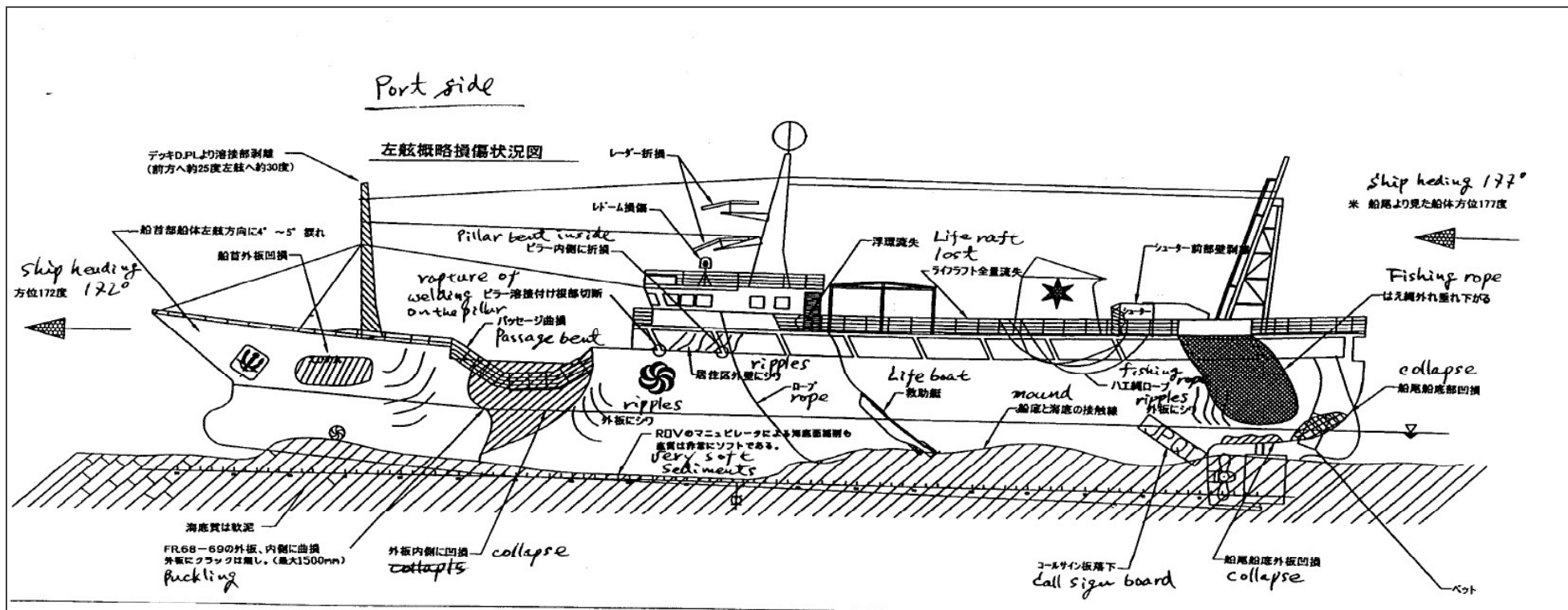

Figure 5-7. Port Side Damage of EHIME MARU.







Figure 5-9. ROV Video Image of Starboard Side Forward Damage.

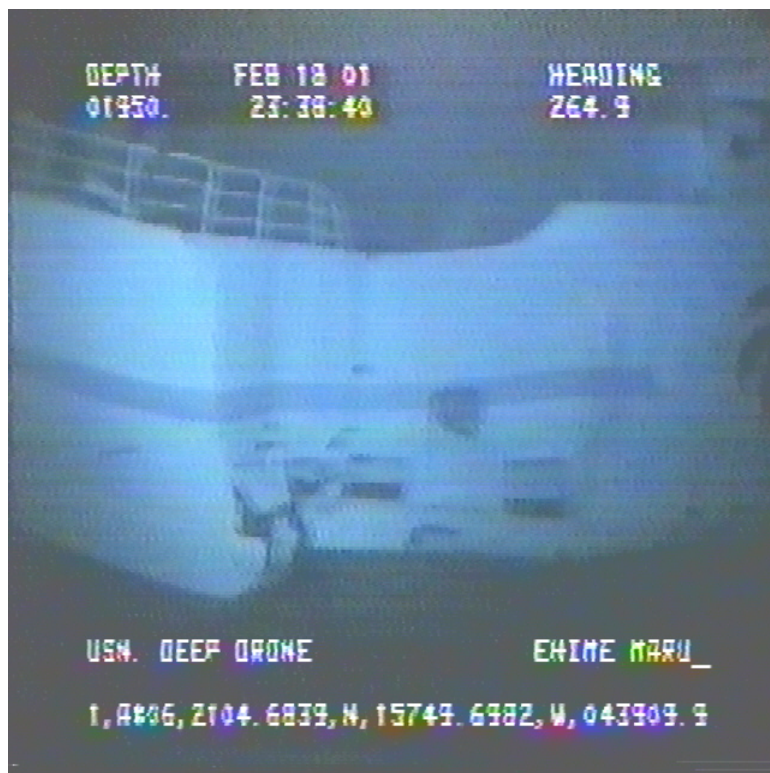

Figure 5-10. ROV Video Image of Port Side Forward Damage.

## **F/V EHIME MARU Recovery and Relocation Report**

The U.S. Navy made the commitment to the surviving family members that if it were technically feasible to raise EHIME MARU the U.S. Navy would do so. Under direction from CINCPACFLT, SUPSALV assembled a feasibility study team composed of NAVSEA 00C, NAVSEA 05, Japanese technical experts, and various contractor personnel.

Four strategies for recovering the crewmembers and personal effects were considered:

1. Deep saturation diving
2. ROV intervention
3. Lift and transfer to sheerleg for placement on a barge or dock in floating dry dock
4. Incrementally lift and move to shallow water

Saturation diving was not considered a viable option because no operational saturation systems capable of working at 2,000 FSW were found and there were significant overall safety concerns.

Remote access into the ships spaces using miniature ROVs was considered but ruled out because it would be impossible for the ROVs to successfully open jammed doors and enter all of the ship's compartments without becoming entangled in debris.

With the first two options eliminated the team had to look at moving the vessel to an area in which personnel could safely search the interior of the vessel. There were two variations to raising EHIME MARU.

One option was to lift her to the surface, and transfer the load to a sheerleg that would then place her on a transport barge. The other option was to lift the ship to the surface and dock it in a floating dry dock. However, two significant factors precluded these options. With all of the compartments full of liquid, almost all water with some oil, the lift would have been 2,000 tons before the water drained out. In the case of the sheerleg lift, structural issues would likely cause significant problems. In both cases, the remaining oil entrapped in the hull would drain out and potentially create a major oil spill. For these reasons, this option was rejected.

The other option, and the one selected, was to raise the EHIME MARU clear of the bottom, and with her suspended below the lift vessel, move her to shallow water, lifting as necessary during the transit, and setting her down on a pre-selected Shallow Water Recovery Site. The divers could then search the vessel for the missing crewmembers at reasonable dive depths. The personal effects and other appropriate ship items could be removed and they could safely prepare EHIME MARU for its relocation to deep-water.

Before concluding that this approach was feasible, a structural analysis of the damaged ship had to be performed. The builder of EHIME MARU provided the “light ship” weight distribution (Figure 5-11) to assist in the analysis.

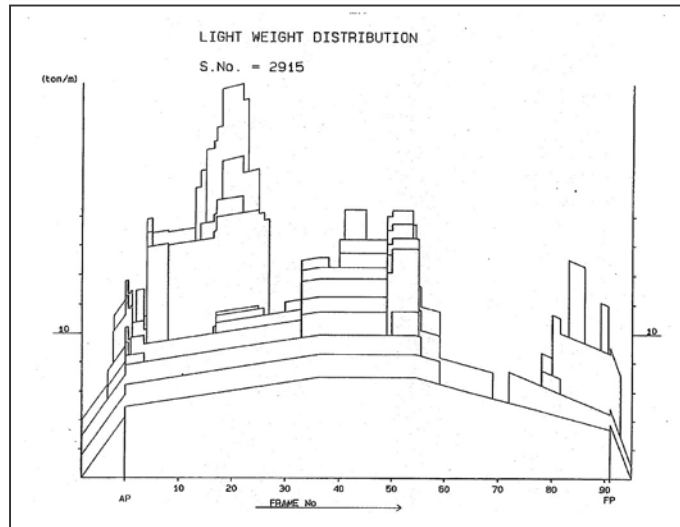

Figure 5-11. EHIME MARU Light Ship Weight Distribution.

Bending moment curves were developed for a number of different lifting arrangements (Figure 5-12). Incorporated into each analysis were reduced section moduli in way of the damaged areas, which assumed a worst-case damage scenario.

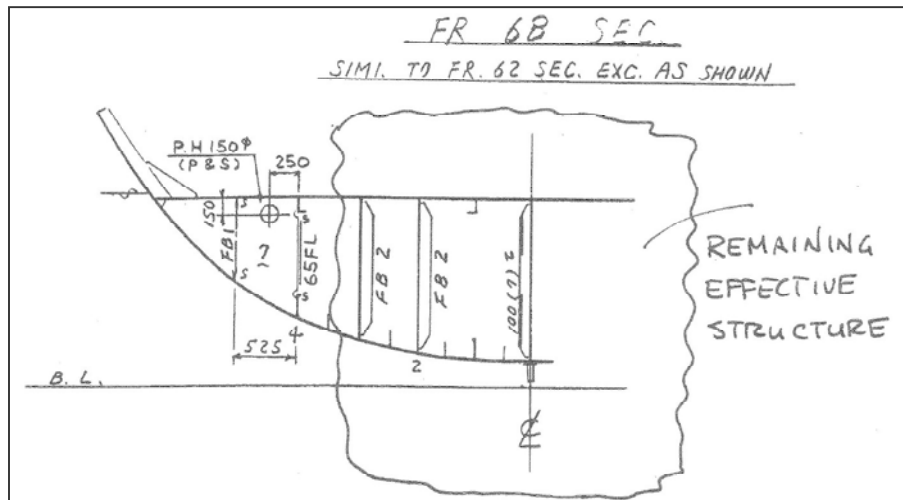
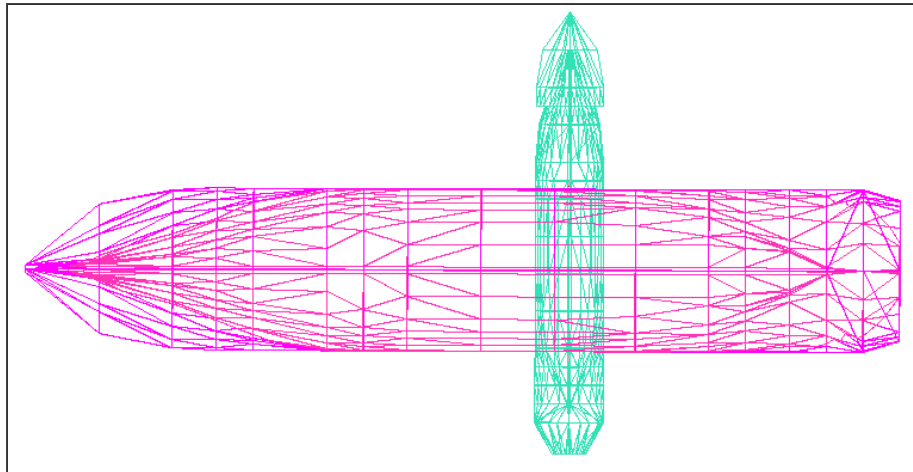

Figure 5-12. Assumed EHIME MARU Bow Damage.

The result of the analyses was that EHIME MARU could withstand a static steady state lift but that the dynamic effect imparted by ocean swells could be a problem. Technical feasibility required an estimate of sea state effects on both the lift vessel structure and stability as well as the structural loading on EHIME MARU. Figure 5-13 depicts a model of the EHIME MARU as it would be suspended beneath ROCKWATER 2.



**Figure 5-13. Computer Model of EHIME MARU with ROCKWATER 2.**

Concurrent with this effort, SMIT engineers conducted an independent analysis and came to the same conclusion as the NAVSEA team. Based on the detailed structural analyses and a concept of recovery operations from SMIT, CAPT Marsh concluded that it was technically feasible to raise EHIME MARU and estimated that there was an 80 percent chance of success. The results of the feasibility study and the odds of success were sufficient to convince CINCPACFLT to pursue the recovery operation. The concept of operations called for placing two large lifting plates beneath the ship and carrying it into shallow water where divers could safely enter and search the vessel. See Figure 5-14.

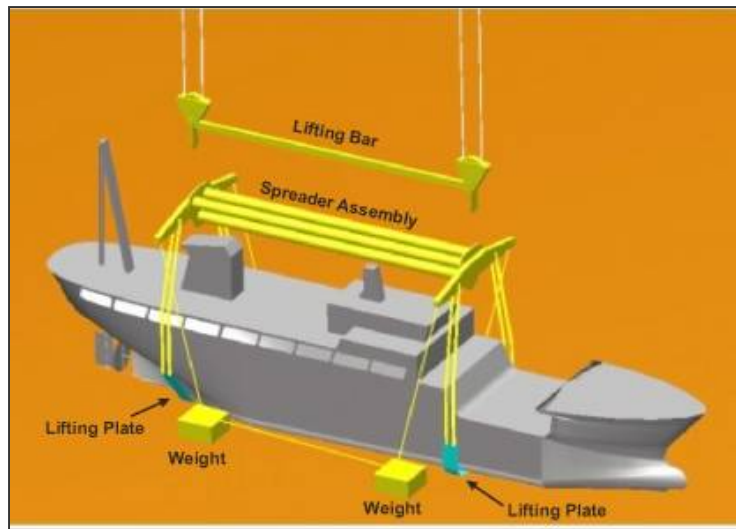

**Figure 5-14. EHIME MARU Lifting Arrangement.**

This required that a site be chosen where the ship could be relocated without causing damage to the environment. Because of the significant environmental issues, CINCPACFLT



was required to complete an Environmental Assessment (EA) before the operation could begin.

## **5.2 Phase I: Environmental Assessment/Mitigation**

The EA was to determine whether the operation to recover crewmembers from EHIME MARU would have any significant impact on the environment.

An object the size of EHIME MARU had never been raised from 2,000 feet of water. It was possible the vessel could suffer additional structural failure during the movement due to the existing damage to its hull and the stresses imposed by lifting and transport. The primary issues that the EA addressed were the potential environmental impact if a major failure occurred and whether the risk was acceptable.

The U.S. Navy worked with federal, local and state agencies to complete the comprehensive EA. The Government of Japan was consulted and kept abreast of developments as the analysis and assessment progressed.

CINCPACFLT N43 (Environmental Division) was chosen to head up this effort. Drawing on assistance from EDAW Inc., from Irvine, CA, numerous subcontractors, NAVSEA 00C pollution engineers, and SUPSALV Emergency Ship Salvage Material (ESSM) contractor personnel, CINCPACFLT completed the assessment in less than 13 weeks at a cost of nearly \$2 million.

EDAW had extensive experience with environmental issues in Hawaii, including preparing EAs for the Pacific Missile Range Facility on Kauai and the RIMPAC exercises that are held in Hawaiian waters every two years.

The state agencies included the Department of Land and Natural Resources and Department of Health. The federal agencies included the Environmental Protection Agency, National Oceanic and Atmospheric Administration, U.S. Fish and Wildlife Service, U.S. Coast Guard, and Federal Aviation Administration.

The assessment examined potential sites to which the ship could be moved, the transit route, tides, winds, currents and sea life in the area. The optimal site would have a flat, sandy bottom about 100 feet deep with minimal tidal flow. Due to the complexity of the proposed plan minimizing the distance to the recovery site was important. The selected Shallow Water Recovery Site is shown in Figure 5-15.

## **F/V EHIME MARU Recovery and Relocation Report**

Support among the various agencies working on the EA was strong. Collectively, they identified many measures to protect the environment that had to be included in the salvage plan. While some of these measures were restrictive, it was very important for the Navy to take all steps necessary to protect the environment during the operation.

For example, the EA required that the Navy provide for the following actions as part of the operation:

- Bird habitats were to be inventoried before and after the operation;
- U.S. Fish & Wildlife Service personnel were aboard oil skimmers to care for any birds that came in contact with the oil;
- Cargo nets, long-line fishing gear and other equipment that could have become a hazard to reefs, turtles or other ocean life were removed from EHIME MARU;
- The ship's initial deep-water location and the shallow-water site were surveyed to ensure no material was left behind;
- An extensive analysis of sea state and wind direction and speed, as well as real-time weather forecasts, were collected and analyzed which allowed the Navy to select the optimal time for the vessel's movement to the shallow-water site.

The Navy moved expeditiously in this process, but also wanted to ensure it was done comprehensively and correctly. The EA was completed by mid-June, allowing sufficient time to complete the recovery operation by the end of the favorable weather season in late summer. This would allow the salvors to take advantage of the best sea state and wind conditions to maximize environmental protection.

The EA culminated with CINCPACFLT signing a "Finding of No Significant Impact" (FONSI) for moving EHIME MARU from its initial deep-water location to about a mile off the Honolulu airport (See Appendix D) and ultimately to the deep water final relocation site.

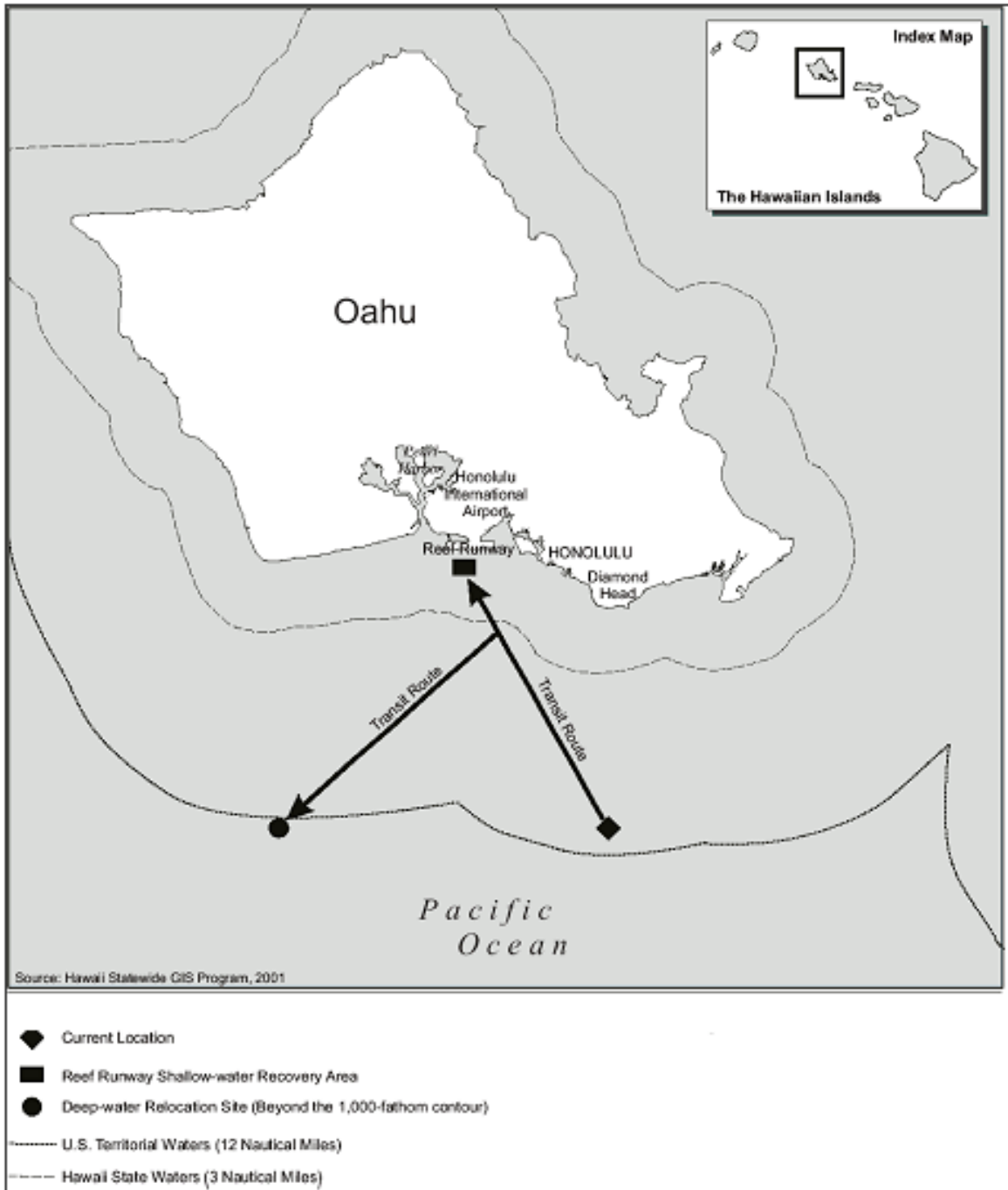

Figure 5-15. Selected Location for the Shallow Water Recovery Site Off Reef Runway.

### 5.3 Phase II: Mobilization of Recovery Forces

The Concept of Operations called for placing two large lifting plates beneath the ship and carrying it into shallow water where divers could safely enter and search the vessel. To accomplish the rigging and lifting operations, specialized offshore equipment was mobilized from Singapore, Europe, Philippines, and the United States.

The major components included:

- DSSV ROCKWATER 2 (Figures 5-16 and 5-17)
- M/V OCEAN HERCULES (Figure 5-18)
- CANYON OFFSHORE ROVs
- Upper and lower lifting assemblies
- Two linear lift winches

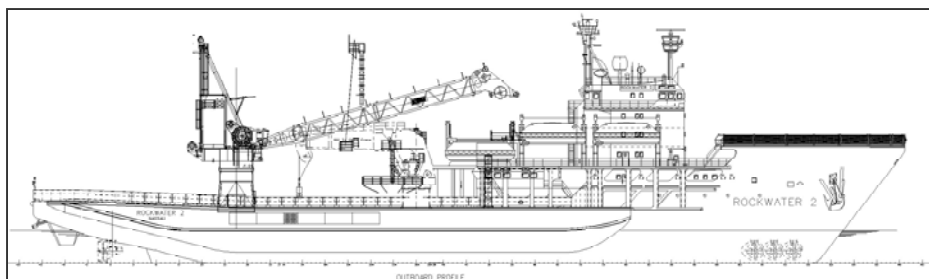

Figure 5-16. ROCKWATER 2.

The winches and lift wire were shipped from Europe to the Keppel Shipyard in Singapore. Lift plates, lifting assemblies and other heavy rigging materials were manufactured at Keppel Shipyard, under direction of SMIT. Since ROCKWATER 2 was completing an operation near the Philippines it was expeditious to outfit her for the operation in Batangas, Philippines. Figure 5-17 shows some of the modifications made to ROCKWATER 2.



Figure 5-17. ROCKWATER 2 Prepared for Lifting (Top left, the lifting sheave has been installed. Bottom left, the load cell measures the tension on the end of the lift wire. Right, the lift wire is installed for testing.)

Three separate ROV systems, a coiled tube drilling unit, and rigging equipment were mobilized from the U.S. Gulf Coast to Port Hueneme, California and barged to Honolulu on the Crowley Marine 250-6 barge. Once ROCKWATER 2 and remaining support equipment arrived in Hawaii, Pacific Shipyard was subcontracted to complete vessel outfitting. This entailed welding down the ROV equipment, installation of portable generators for the deck equipment, and welding of additional rigging equipment for the deep ocean lift.

#### 5.4 Phase III: Rigging w/ROV in Deep Water

This phase of the operation included preparation of EHIME MARU for lifting from 2,000-foot depth and moving it to the SWRS. It also included clearing away some debris, (items that would interfere with the lifting equipment) installing 2 lifting plates under the hull, and installing the lifting assemblies.

The operation utilized two support platforms during this phase; OCEAN HERCULES, Figure 5-18, and ROCKWATER 2. Because time was critical, while ROCKWATER 2 was being mobilized and outfitted with special deep-water salvage equipment, ROVs, and lifting assemblies for the lift of EHIME MARU, the cable laying ship OCEAN HERCULES was brought in to prepare EHIME MARU for the work to be done by ROCKWATER 2.

To provide accurate navigation at the deep water site, an array of acoustic transponders were placed on the sea floor around EHIME MARU and on three locations aboard EHIME MARU. The transducers aboard EHIME MARU were at the bow, the stern and amidships. There were 10 transducers placed on the sea floor with one forward of the bow, one aft of the stern, and four on each side of the vessel, all located approximately 100 yards from EHIME MARU. This



Figure 5-18. M/V OCEAN HERCULES.



Figure 5-19. ROV Phoenix III.



array of transducers created the fixed portion for a short baseline navigation system and allowed the ROVs and ROCKWATER 2 to position themselves to work on the vessel.

In order to remove the center mast of EHIME MARU and clear the way for installation of the lifting assembly, the ROV Phoenix III, Figures 5-19 and 20, used a cutting tool to remove debris and handrails in preparation for placing a shaped explosive cutter (Figure 5-21) to cut the mast from the deck. Jet Research Corp. was subcontracted to develop a special cutter to cut the mast off. The ROV was used to place the pre-formed explosive charge around the mast (Figure 5-22). Because of the irregular surface and shape of the mast, the explosive charge only partially cut through it and the ROV used a cutting tool to complete the cut.

While ROVs can operate at depth for extended periods of time, a limiting factor during this portion of the operation was the wear rate of the underwater cutting tools. The ROV needed to periodically surface from 2,000 feet for tool blade replacement.

PHOENIX III was also used to remove some of the fishing gear, other debris and items that would interfere with the lifting assemblies. PHOENIX III also installed the array of underwater navigational



**Figure 5-20. ROV Phoenix III Recovering EHIME MARU Rigid Hull Inflatable Boat.**



**Figure 5-21. Shaped Explosive Charge Tool to Aid in Removal of the Center Mast.**



**Figure 5-22. Shaped Explosive Charge Tool in Expanded Position to Allow for Going Around the Mast.**

transponders around the sunken vessel to support the precise navigation requirements of ROCKWATER 2 and the ROVs.

After her final outfitting in Hawaii, ROCKWATER 2 immediately transited to the DWRS, relieving OCEAN HERCULES and beginning the complex rigging effort for the relocation.

ROCKWATER 2 is a multi-purpose support vessel with dynamic positioning capability, a heave compensated crane, and other unique features necessary for performance of the operation. She was outfitted with special drilling equipment, linear traction winches, lifting wires, three Remotely Operated Vehicles, and material fabricated for the operation. (See Figure 5-23)



**Figure 5-23. ROCKWATER 2.**

The success of the recovery and relocation of EHIME MARU was, in large part, due to the fact that the operators of the vessels and ROVs had a common operational picture of the deep ocean environment. The ability to maintain and distribute an accurate representation of the underwater scene was key to coordinated and successful remote operations.

**Data Visualization:**

This application provided the visualization of the “world model” from a pre-determined perspective. This system consisted of five viewing stations located around the recovery vessel, ROCKWATER 2:

- One on the bridge supporting the Master and Mates on duty
- One in the logistics room supporting the Salvage Master, project engineers and observers
- One in each of the ROV vans supporting the operators of the Manta, XL-16 and the Quest

The virtual images show the ROV, vessels, lifting assemblies, and seafloor by using computer-aided design (CAD) based technology model with advanced features to allow for real-time display, and also provided real-time relative distances between the ROVs and other modeled items. (See Figure 5-24) Utilization of the “world model” provided the vessel and ROV operators with essential information in the planning, execution, and evaluation of the EHIME MARU recovery operations. The visual images of EHIME MARU and the ROVs during the planning and execution phases of the operations were essentially identical.

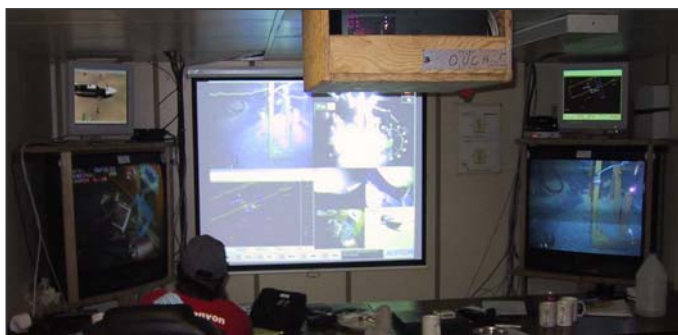
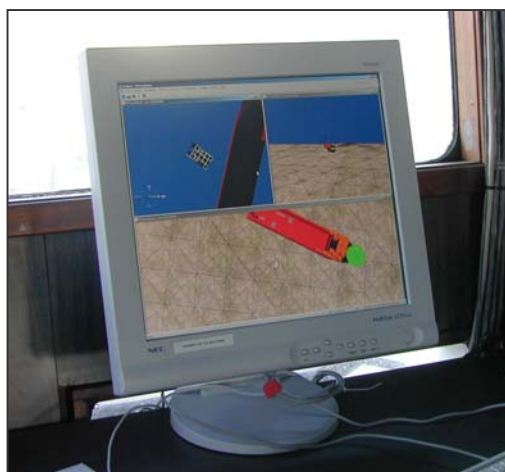

**Figure 5-24. 3-D Visualization Display Photo and the Quest's Theater View Projection System.**



There were three ROVs that operated off ROCKWATER 2, all provided by Canyon Offshore, the Manta, XL-16, and the Quest. The XL-16 and the QUEST were routinely used as together to conduct work tasks, rigging connections, and observations. The Manta was principally used as an observation vehicle to assist the two work vehicles.



Figure 5-25. MANTA, Observation Class ROV.

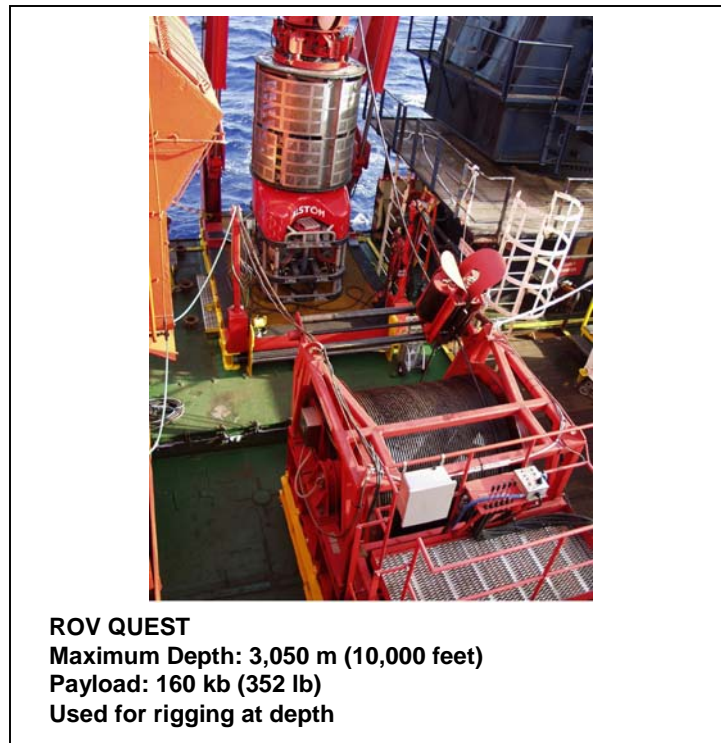
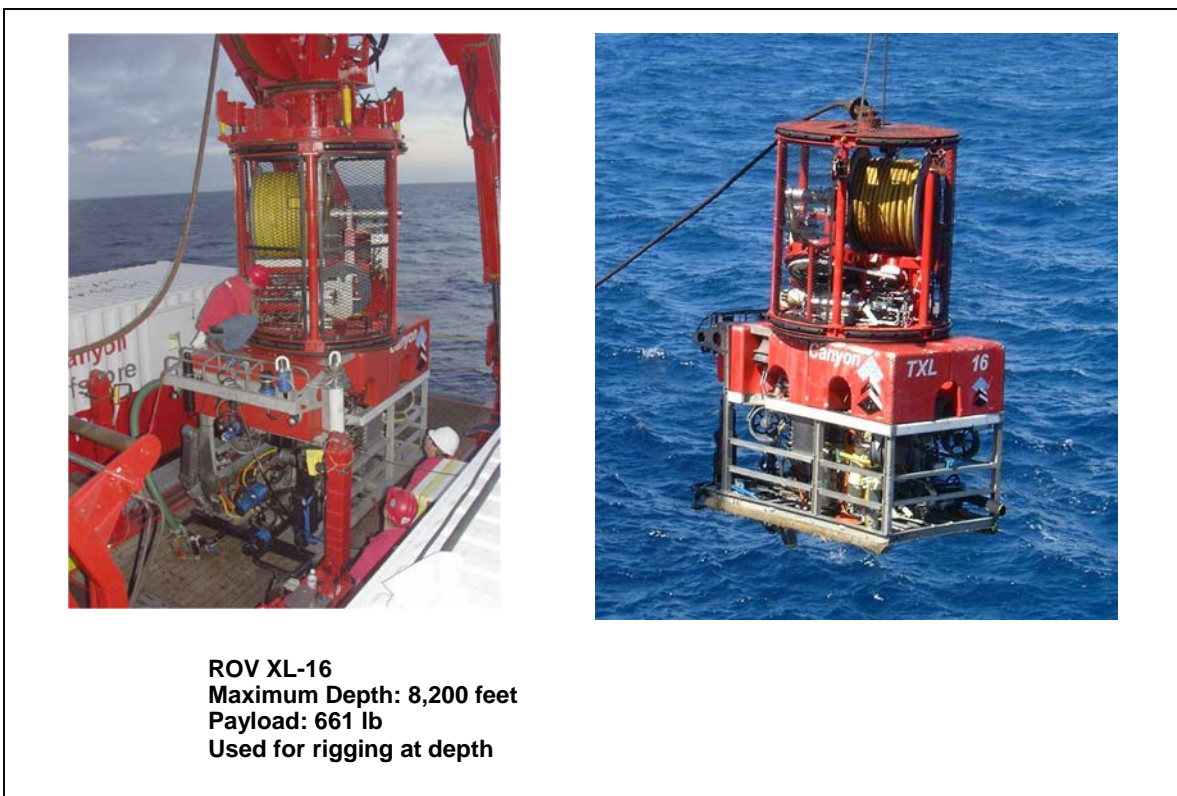

Figure 5-26. Quest Electric Work Class ROV.



**Figure 5-27. XL-16 Work Class ROV.**

Once calibration of the navigation array was complete, the recovery team went to work on putting two large lifting plates beneath the hull. These lifting plates would be attached to the lifting assemblies above the hull, and by raising the assemblies, EHIME MARU would be lifted clear of the sea floor and transported to the Shallow Water Recovery Site (SWRS).

The positioning of the plates under the hull was based on the observed and assumed damage to EHIME MARU. The forward plate needed to be placed under the hull beneath the forward bridge wing (Frame 65) and the aft plate under the hull forward of the propeller (Frame 15). This would minimize stress on the damaged hull structure.

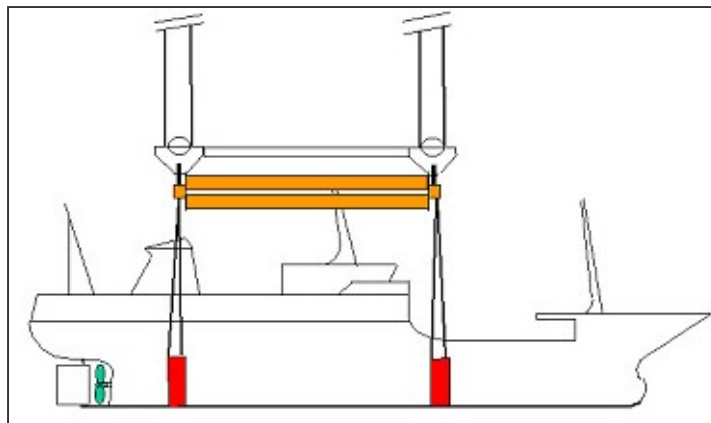

**Figure 5-28. Plate Location.**

The plan for passing the lifting plates under the hull was to use a technology called coiled-tubing drilling (CTD). This technology is routinely used for drilling into oil wells, but it had never been adapted to deep ocean salvage work nor operated by ROVs.

The general principle of coiled tube drilling is to pump high-pressure water through 2<sup>3</sup>/<sub>8</sub>-inch outside diameter steel tube outfitted with a drilling nozzle on the end to fluidize the sediment in front of and around the nozzle and essentially "drill" with the high pressure water jet through the soil under the hull and have the nozzle reappear on the opposite side of the hull. The tube unwinds off a spool, goes through a shaping tool with controllable rollers that shape the tube with a bend appropriate to the curvature of the hull. This technology allowed the placement of the lifting slings without stressing the hull during process.

In concept, the CTD system would pass the nozzle under the hull. A ROV would then attach a messenger wire to the nozzle and the CTD system would withdraw the nozzle, pulling the messenger under the hull. Once the messenger was in place under the hull the ROV would disconnect it from the CTD nozzle and attach it to the lifting plate, which had been placed on the sea floor next to the hull. ROCKWATER 2 would then heave in on the messenger, which was faired through a pulley attached to a clump weight placed on the opposite side from the lift plate. A submersible seawater hydraulic pump was used to power water jets installed on the leading edge of the plate. This was intended to help overcome friction while pulling the large lift plate under the hull. Figure 5-29 shows the CTD sequence.

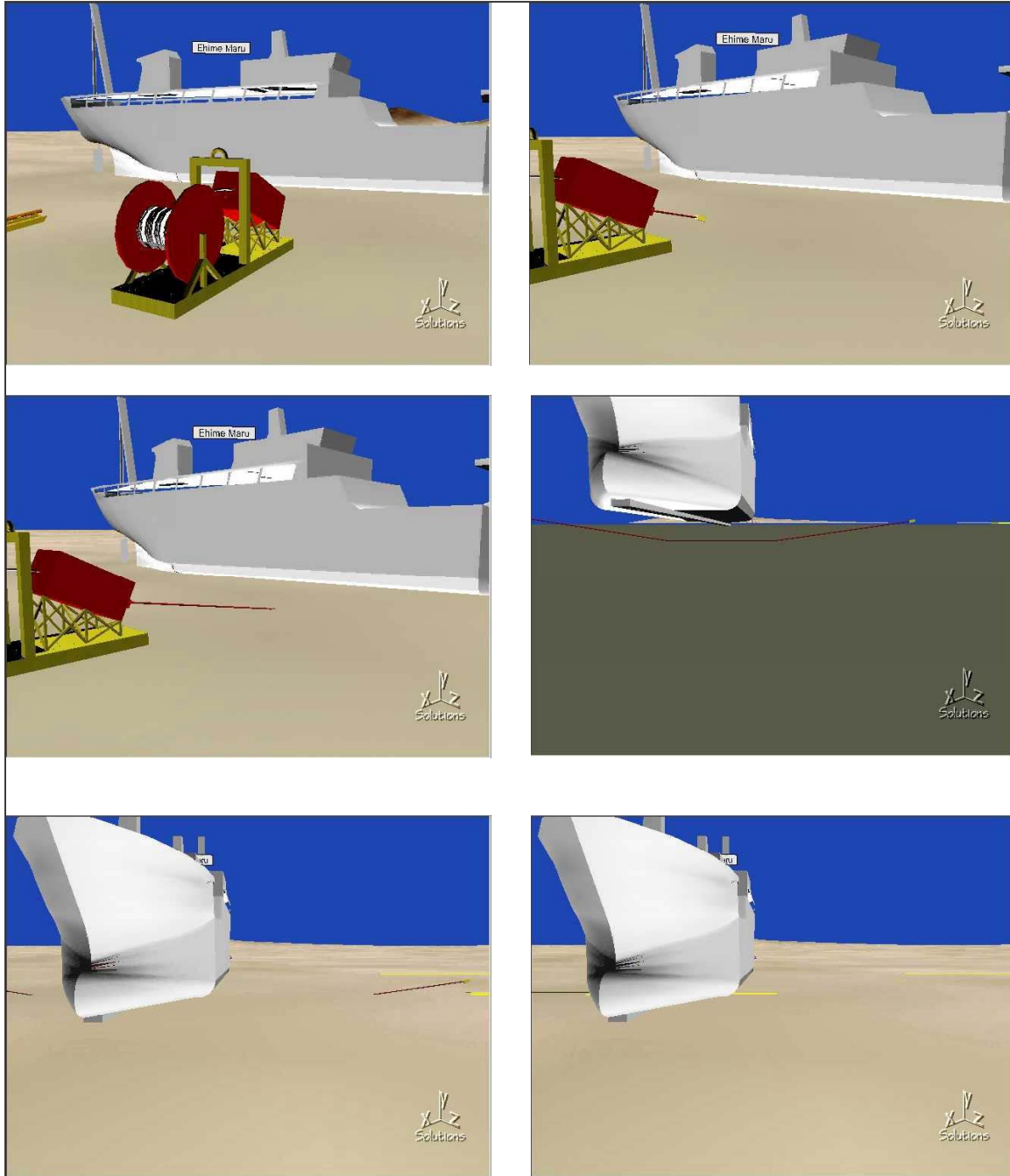

Figure 5-29. Coiled-Tubing Drilling (CTD) Concept Sequence.





**Figure 5-30. Coiled-Tubing Drilling (CTD) System Was Evaluated Through Testing in Houston, TX.**

This was a new application of the CTD technology. It was fabricated and successfully tested on land in Houston, Texas prior to deployment in Hawaii. For the test, a model of a hull section was used to simulate EHIME MARU on the bottom but the engineers could not model the soil conditions that would be encountered at the DWRS. Figures 5-30 and 5-31 show the system during testing in Houston.



**Figure 5-31. Nozzle Exiting Coiled-Tubing Drilling System.**

While the modified system was successfully demonstrated in the Houston test, when it was deployed at the salvage site numerous problems arose. Repeated attempts were made to pass the nozzle under the hull, but in each case it would enter the bottom but not re-appear on the other side. In some tries it appeared to run into an obstruction under the hull, and at other times, even with 200 feet of tube out, it did not re-appear. As a test at depth, the unit was turned so that the nozzle direction was forward parallel to the centerline of EHIME MARU, with the unit near the starboard bow. During two tests it worked as predicted and the nozzle reappeared 35 to 70 feet away from the bottom entry point. When turned under the hull again the system was not able to pass under the hull and reappear on the other side.

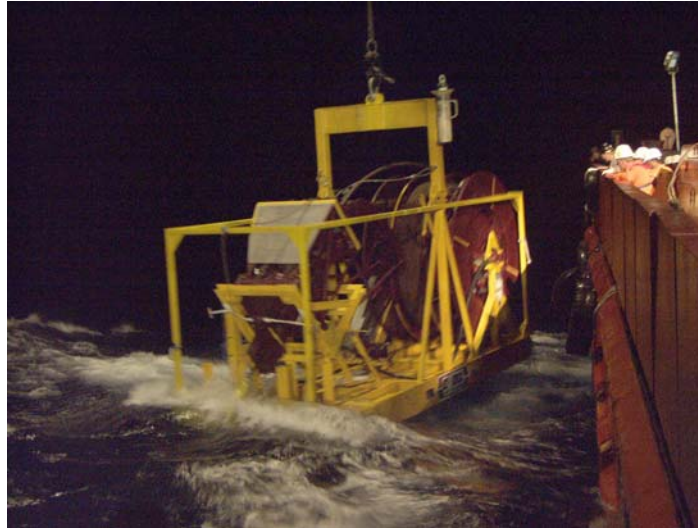
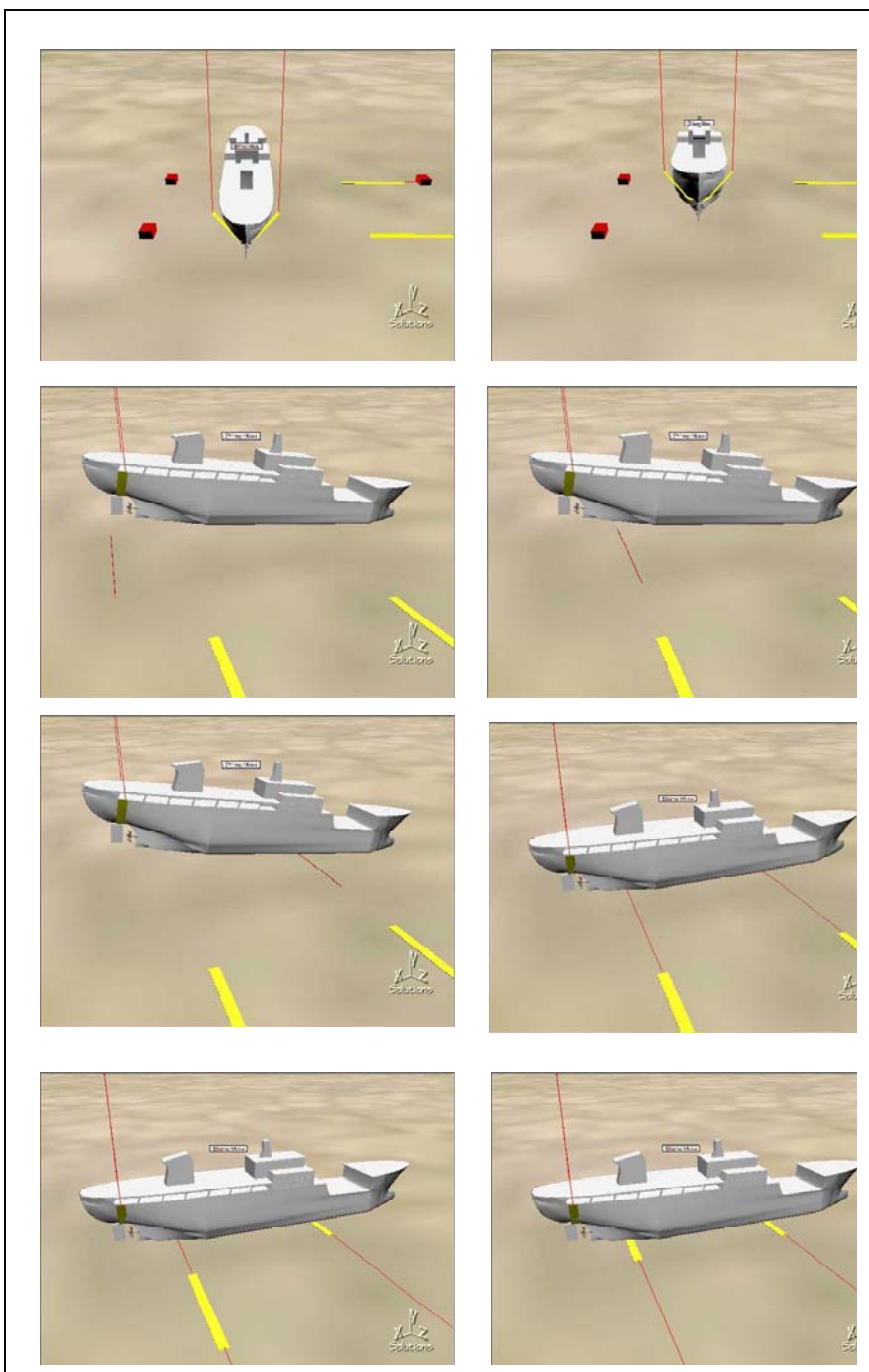

**Figure 5-32. Launching Coiled-Tubing Drilling System.**



**Figure 5-33. Coiled-Tubing Drilling System Being Deployed.**

While it is impossible to know for sure, one of two things likely prevented the nozzle from passing under the hull. Either the impact of the bow on the sea floor caused a large “hole” under that part of the hull, and without the support of firm soil under the hull, the nozzle drifted off in an unknown heading. The other theory is that during the initial attempts the water jets fluidized the soil so that it would not support the nozzle as it was pushed under the hull. In either event, after many attempts, this approach was abandoned.



**Figure 5-34. Stern Lift Concept.**

Recognizing the risk of using unproven technology in a salvage environment, SUPSALV and SMIT had a contingency plan that involved lifting the stern of the vessel and passing the messengers beneath it while suspended. After the messenger wires were passed under the stern, the lifting plates would be pulled into place. Figure 5-34 shows a series of illustrations demonstrating this approach.



By using a lifting plate in the propeller opening just forward of the rudder, the stern was lifted, but the messenger could not clear the hull plates damaged during the collision with the submarine's rudder. A second stern lift was attempted but the lift plate failed due to fatigue from the first attempt.



**Figure 5-35. Broken Lifting Plate After Stern Lift.**

For the next attempt, the team used a wire rope reinforced lifting plate (Figure 5-36). This time, the attempt was successful. With the stern suspended well clear of the sea floor, the ROV pilots pulled a messenger wire underneath the after area of the hull, but were unable to install the forward messenger. Speculation, which later proved to be correct, was that some damaged structure protruding from the hull was interfering with the messenger as the ROVs attempted to slide it forward towards the bow.



**Figure 5-36. Reinforced Lifting Plate.**



After the stern of the vessel was set back down the ROVs were used to rig one end of the aft messenger wire to the lifting plate and the other end to a heave compensated crane aboard ROCKWATER 2. With this setup, the crane was successfully used to pull the after lifting plate underneath the hull. The forward plate posed a new challenge. When the stern was lifted the pivot point was at the bow, causing it to sink up to the hawse pipes. This meant the salvors had to come up with a new plan for installing the forward strap.

Because they were unable to pass a messenger under the bow a plan was developed to lift the ship by using the stern plate and a temporary lift wire placed around the bow, through the hawse pipes. The ship would then be moved laterally over and lowered onto the forward lift plate, which had been placed on the sea floor nearby.

Rigging sling arrangement through hawse pipe

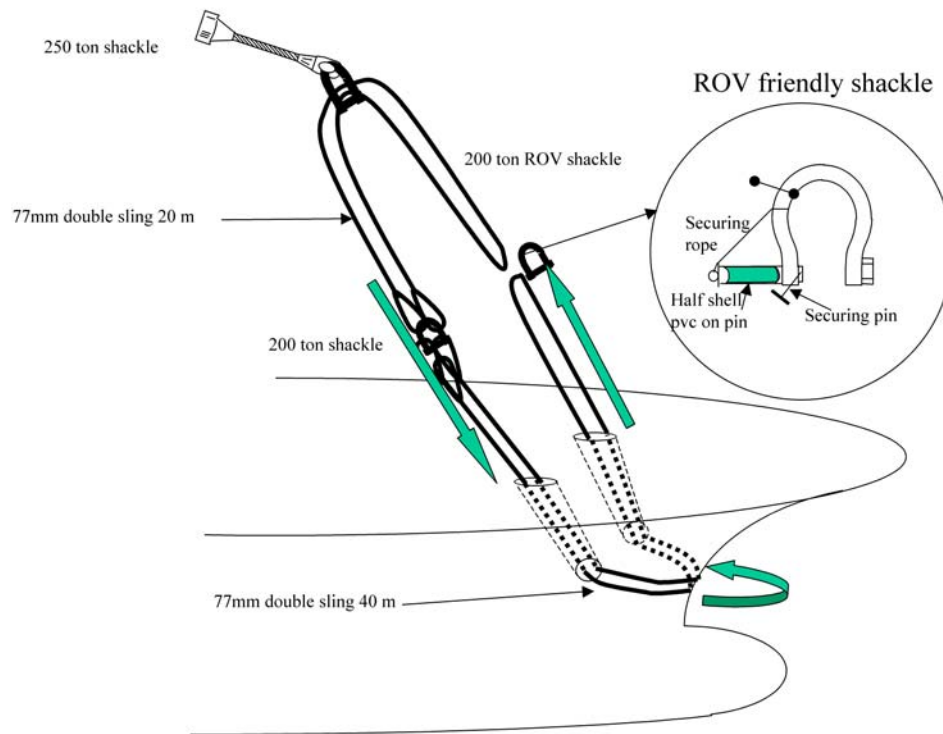

**Figure 5-37. Concept to Lift Bow By Using the Hawse Pipes.**

Lifting the bow by using the hawse pipes required the development in the field of an ROV friendly shackle as shown in Figure 5-37.



Figure 5-38. Sediment on Bow After the Stern Lift Viewed from Above Port Bow.



Figure 5-39. Sediment on Bow Viewed from Above Starboard Bridge Wing.

Rigging the forward lift plate presented the salvors with a major problem. With the bow buried to the hawse pipes, the ROVs would have to dredge the area around the anchors to facilitate their removal and installation of the temporary lift wire. The sediment that accumulated on the forward decks of EHIME MARU also needed to be removed to reduce stress on the vessel and the temporary rigging during the lift. The salvors recognized that this plan could overstress the already damaged hull. However, experience lifting the stern of the vessel without noticeable deformation of the damaged bow area, and additional viewing of the “z” form of the buckled side shell plating forward, gave them confidence that a

limited duration lift could be done successfully. Transporting EHIME MARU to shore lifting by the hawse pipes presented an unnecessary risk, and was not considered.



Figure 5-40. Suction Hose Removing Bow Sediment.

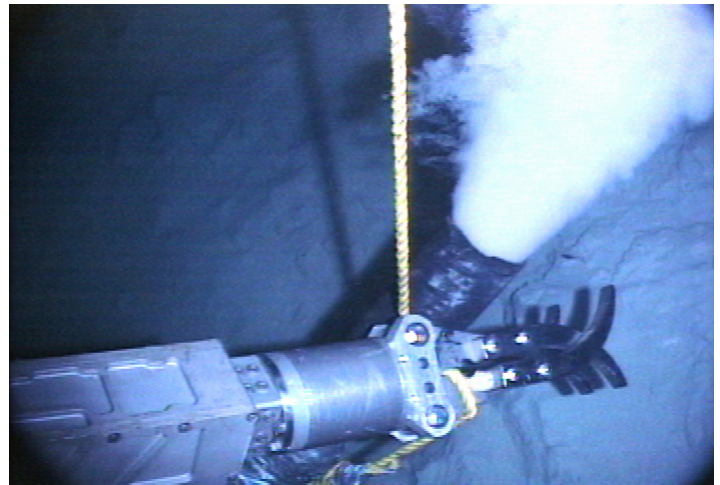

Figure 5-41. Dredge Hose Output.

While the procedure was effective, the time it took to conduct the dredging was considerable. The process of dredging was accomplished by two ROVs. One ROV manipulated the suction hose and the second ROV was positioned at the discharge end to determine if any dredge material was being pumped. During the dredging effort the operator of the ROV at the suction end had little or no visibility and great difficulty determining if the dredge suction was working. By watching the video from the ROV monitoring the discharge, the suction ROV operator was able adjust the position of the suction head to optimize the dredging rate.



Figure 5-42. The Anchor Chains Were Cut and the Anchors Removed from the Hawse Pipes.



Once the dredging was complete the anchors had to be removed to clear the way for the temporary lift wire. A loop was rigged through the hawse pipes, down one and up through the other. The recovery team then positioned the lower lifting assembly in place above EHIME MARU. The lifting assembly was equipped with flotation material that would suspend it over EHIME MARU before the actual lift commenced. Four clump weights were attached to the assembly to hold it in position above EHIME MARU during the rigging process.

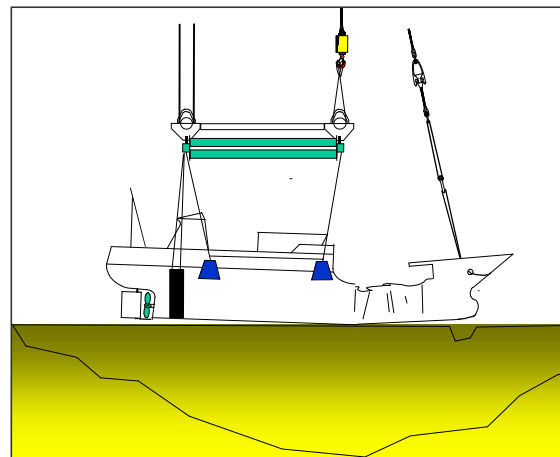

**Figure 5-43. Lower Lifting Assembly During Fit Out with One Upper Sheave.**

Since they were deviating from the original plan of using two lifting plates as illustrated in Figure 5-14, they had to reconfigure the rigging. Instead of attaching both the forward and aft lift wires to the spreader assembly, only the aft lift wire was attached.

In order to balance the spreader assembly and keep it parallel to EHIME MARU's keel, the heave compensated crane aboard ROCKWATER 2 was attached to the forward end of the assembly, and the aft end of the assembly attached to EHIME MARU at the aft positioned lifting plate.

The temporary lift wire through the hawse pipes was then passed through a lifting sheave to one of the linear winches on ROCKWATER 2. The stern lifting wire was passed through the other sheave to the other linear winch. This lifting configuration is illustrated in Figure 5-44.



**Figure 5-44. Temporary Bow Lift Configuration.**



Figure 5-45. ROVs and DELMAR Connectors.

In order to make connections at depth with connectors that have the capability to hold hundreds of tons of weight, Delmar connectors were used (Figure 5-45). The male half, attached to the lifting plate, was rigged with a bouyant collar to hold it vertically in the water column. That allowed the ROV to connect it to the female half on the lift wire, suspended from ROCKWATER 2. However, when they deployed the lift plate/delmar connector, they discovered that the foam collar did not provide enough bouyancy to hold the connector vertically. To solve this they used a wire from ROCKWATER 2 to hold it in position and the ROV was able to make the connection. With the rigging complete, they successfully lifted the entire vessel and moved it laterally onto the originally designed forward lift plate, pre-positioned on the sea floor nearby.

Figure 5-46 shows moving EHIME MARU over onto the pre-positioned bow plate by lifting the bow by the anchor hawse pipes. This procedure enabled the team to attach the forward and as well as the aft lift plates to the lift assembly as originally designed.

F/V EHIME MARU Recovery and Relocation Report

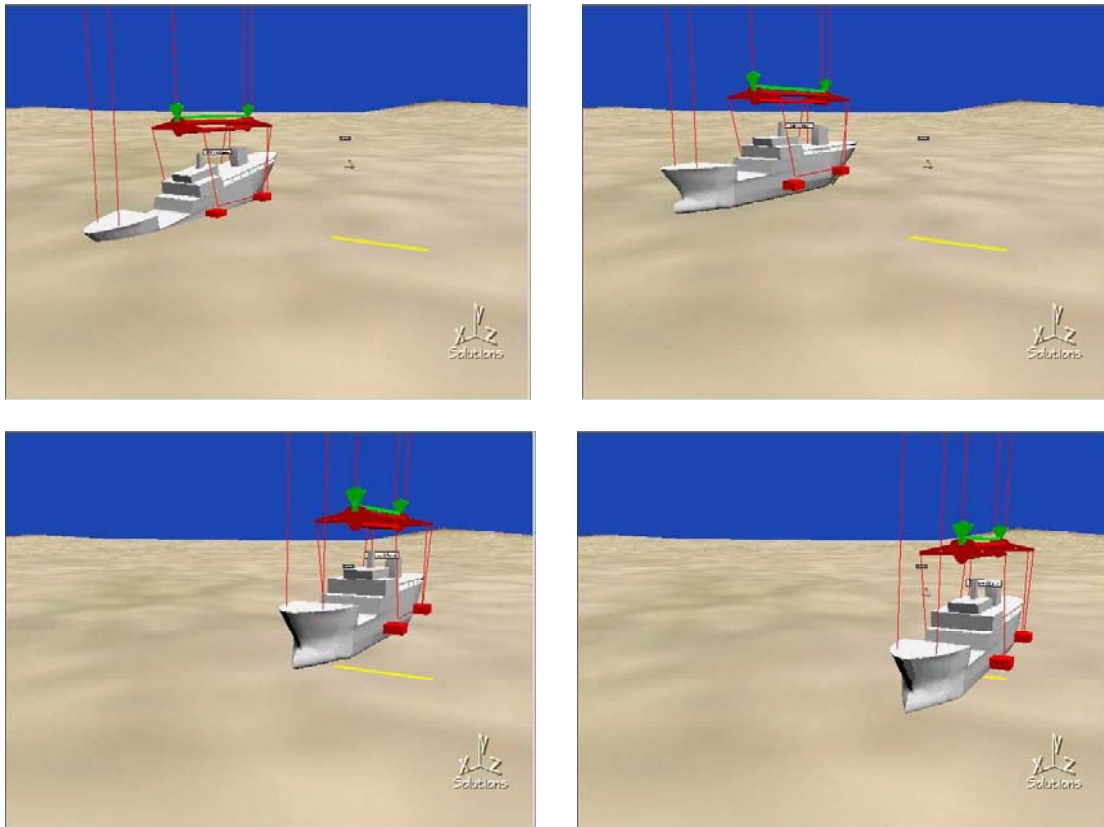

Figure 5-46. Concept of Lifting EHIME MARU.

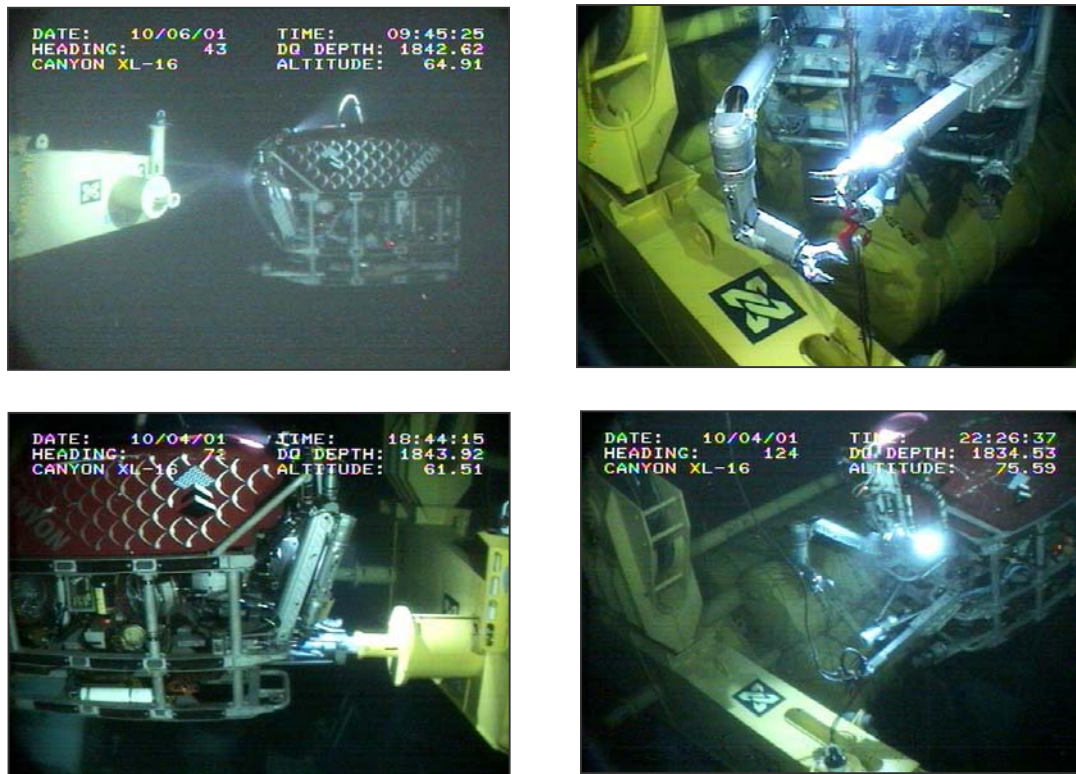
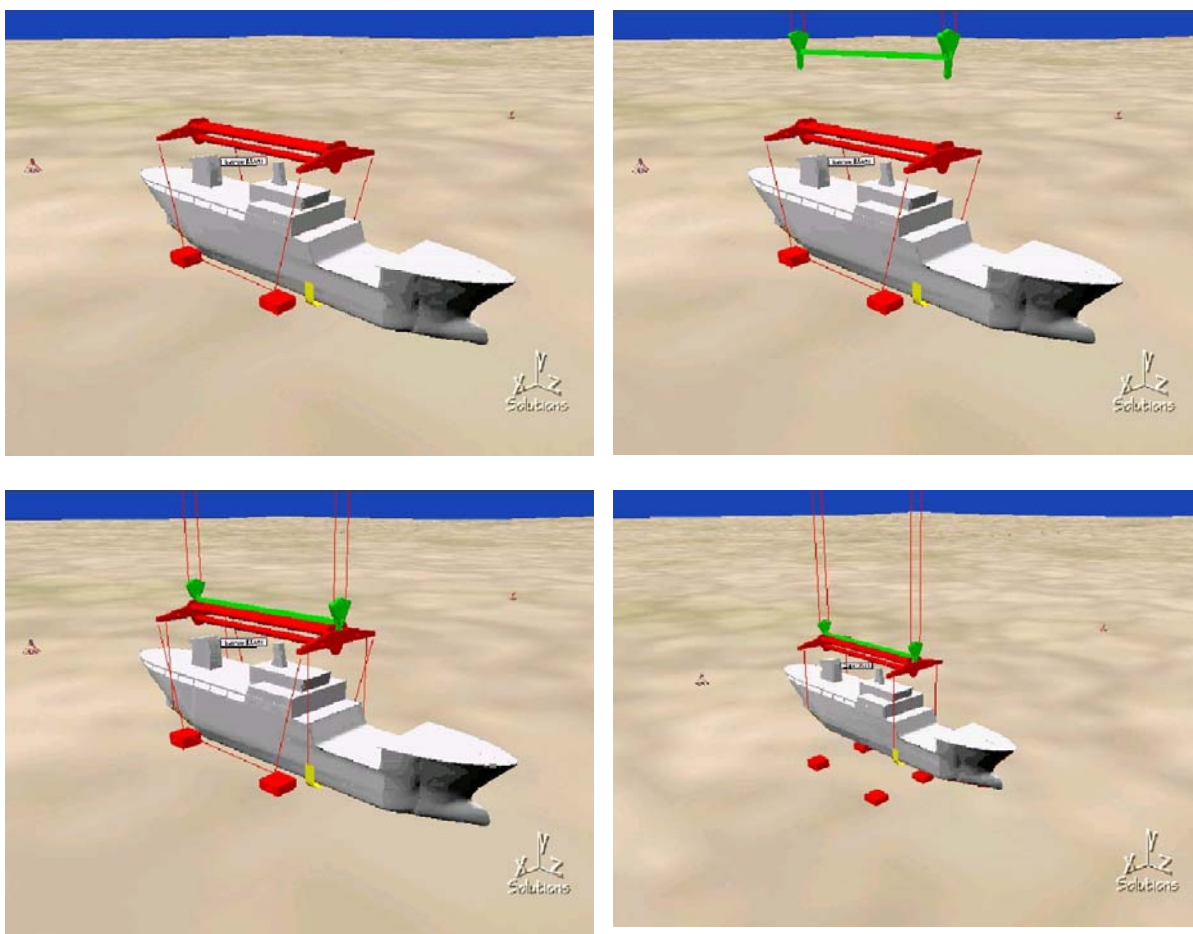

Figure 5-47. Connecting Lifting Plate to the Lifting Assembly.



The next step was to lower the upper lift assembly down from ROCKWATER 2 with the hydraulic linear winches. The two linear winches (a 500-ton and a 350-ton) were installed such that their lift wires and associated sheaves went over the port and starboard sides of ROCKWATER 2 at about amidships. Once the upper assembly was in position it was connected to the lower lift assembly. The entire connection process was accomplished using the ROVs, the two cranes on ROCKWATER 2, and the two linear winches.



**Figure 5-48. Upper and Lower Lifting Assemblies.**

The transit to the Shallow Water Recover Site required attaching the lower and then the upper lifting assemblies, disconnecting the weights that kept the lifting assemblies from floating away during hook up, lifting the vessel, and then transiting. Figure 5-48 is an illustration of the upper and lower lifting assemblies and the process of letting go of the weights.

### 5.5 Phase IV: Deep-water Lift and Transit to Shallow Water Recovery Site

On 11 October, with all the rigging hardware connected, EHIME MARU was ready to be lifted as soon as favorable weather conditions appeared. Environmental risk factors were predominant in consideration for the lift and transit. A decision assist graphic was prepared for the transit and is shown in Figure 5-49.

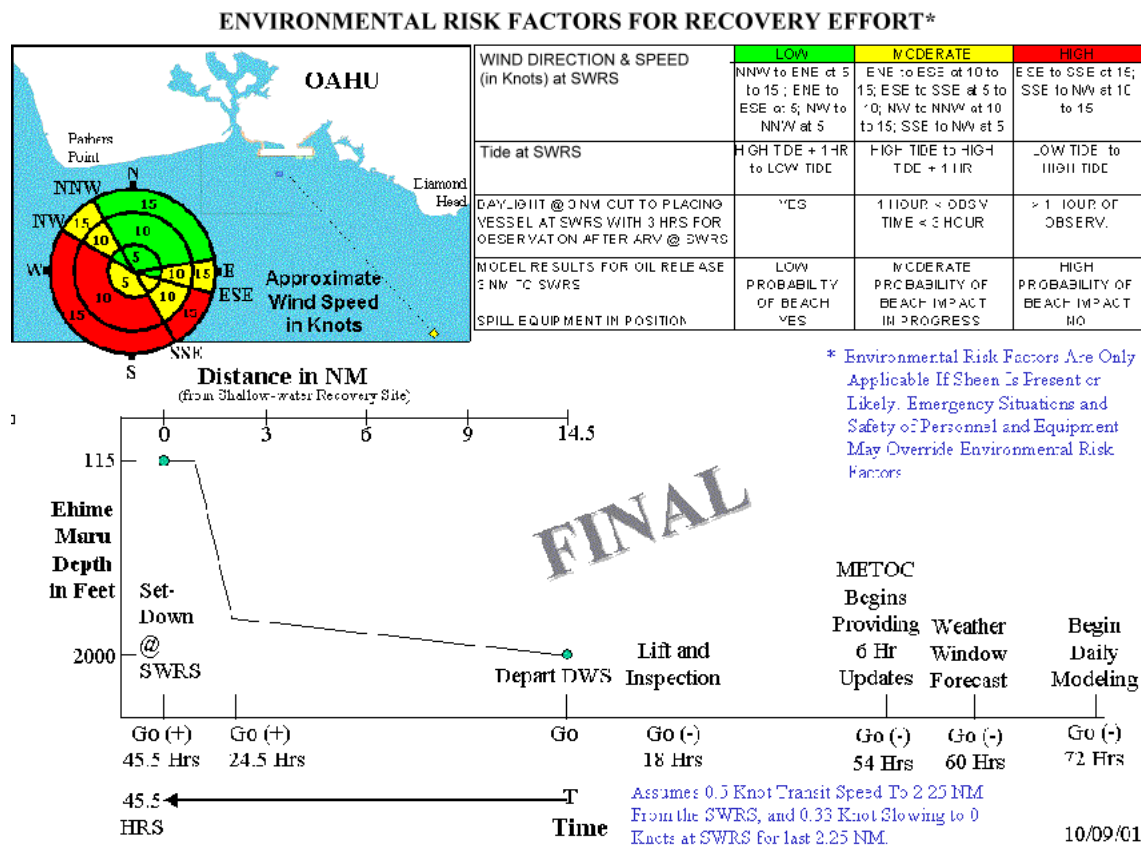

Figure 5-49. Environmental Risk Factor Decision Assist Graphic.

A tide and daylight analysis was conducted for a 0.33-knot transit speed. The transit speed analysis is provided in Figure 5-50.



Tide and Daylight Analysis – 0.33-Knot Transit Speed

Set Down @ SWRS Date	Sunrise	Sunset	Time to Sunset after Set Down	Duration of Darkness from 1.5 NM to SWRS	Combined Window MAX Ebb – 2 hours or Max EBB + 3 Hours	High Tide Cond ???	Set Down Time for Max Ebb Tide	High Tide (at SWRS) When 1.0 NM From SWRS
9-Oct	6:25	18:12	5:24			HH	10/9/2001 12:48	10/9/2001 9:48
10-Oct	6:26							
10-Oct		18:11						
11-Oct	6:26							
11-Oct		18:10						
12-Oct	6:26							
12-Oct		18:09						
13-Oct	6:27							
13-Oct		18:08						
14-Oct	6:27							
14-Oct		18:08						
15-Oct	6:27							
15-Oct		18:07						
16-Oct	6:28							
16-Oct		18:06						
17-Oct	6:28							
17-Oct		18:05						
18-Oct	6:28							
18-Oct		18:04						

**F/V EHIME MARU Recovery and Relocation Report**

Set Down @ SWRS Date	Sunrise	Sunset	Time to Sunset after Set Down	Duration of Darkness from 1.5 NM to SWRS	Combined Window MAX Ebb - 2 Hours or Max Ebb + 3 Hours	High Tide Code	Set Down Time for Max Ebb Tide	High Tide (at SWRS) When 1.0 NM From SWRS
9-Oct	6:25	18:12	5:24			HH	10/9/2001 12:48	10/9/2001 9:48
10-Oct	6:26					LH	10/10/2001 1:18	10/9/2001 22:18
10-Oct		18:11	4:10	-		HH	10/10/2001 14:00	10/10/2001 11:00
11-Oct	6:26					LH	10/11/2001 2:54	10/10/2001 23:54
11-Oct		18:10	3:10	-		HH	10/11/2001 15:00	10/11/2001 12:00
12-Oct	6:26			-		LH	10/12/2001 3:54	10/12/2001 0:54
12-Oct		18:09	3:00*		0:45 earlier	HH	10/12/2001 15:54	10/12/2001 12:54
13-Oct	6:27			-		LH	10/13/2001 4:48	10/13/2001 1:48
13-Oct		18:08	3:00*		1:16 earlier	HH	10/13/2001 16:24	10/13/2001 13:24
14-Oct	6:27			-		LH	10/14/2001 5:30	10/14/2001 2:30
14-Oct		18:08	2:00*		1:16 earlier	HL	10/14/2001 17:24	10/14/2001 14:24
15-Oct	6:27			-		H=L	10/15/2001 6:12	10/15/2001 3:12
15-Oct		18:07	2:00*	3:00	1:59 earlier	H=L	10/15/2001 18:06	10/15/2001 15:06
16-Oct	6:28		8:38	0	2:34 later	HH	10/16/2001 6:54	10/16/2001 3:54
16-Oct		18:06		3:00		LH	10/16/2001 18:48	10/16/2001 15:48
17-Oct	6:28		8:37	0	1:58 later	HH	10/17/2001 7:30	10/17/2001 4:30
17-Oct		18:05		3:00		LH	10/17/2001 19:24	10/17/2001 16:24
18-Oct	6:28		8:36	0	1:16 later	HH	10/18/2001 8:12	10/18/2001 5:12
18-Oct		18:04		3:00		LH	10/18/2001 20:00	10/18/2001 17:00

Assumptions:

1. 0.33 knot transit speed after lift at shelf face
2. 2.25 NM Transit from lift at shelf face to SWRS

\* indicates time to sunset is adjusted for the shift reflected in the Combined Window column for optimized daylight and tide

HH = Higher High tide for that day

LH = Lower High tide for that day

H=L is for days when the HH is equal to or nearly equal to LH

**Figure 5-50. Tide and Daylight Analysis.**

ROCKWATER 2, EHIME MARU, and the lift system were computer modeled for dynamic motions and forces based on the sea conditions, and the predicted orientation and configuration of the proposed lift. The model aided in determining when the wind and wave conditions would cause excessive loads on EHIME MARU, the lifting system, and the effect on ROCKWATER 2. The critical parameter that was calculated was the Dynamic Amplification Factor (DAF), which is an indicator of how much load the lift system must withstand greater than the lift of the vessel in calm, no current conditions.

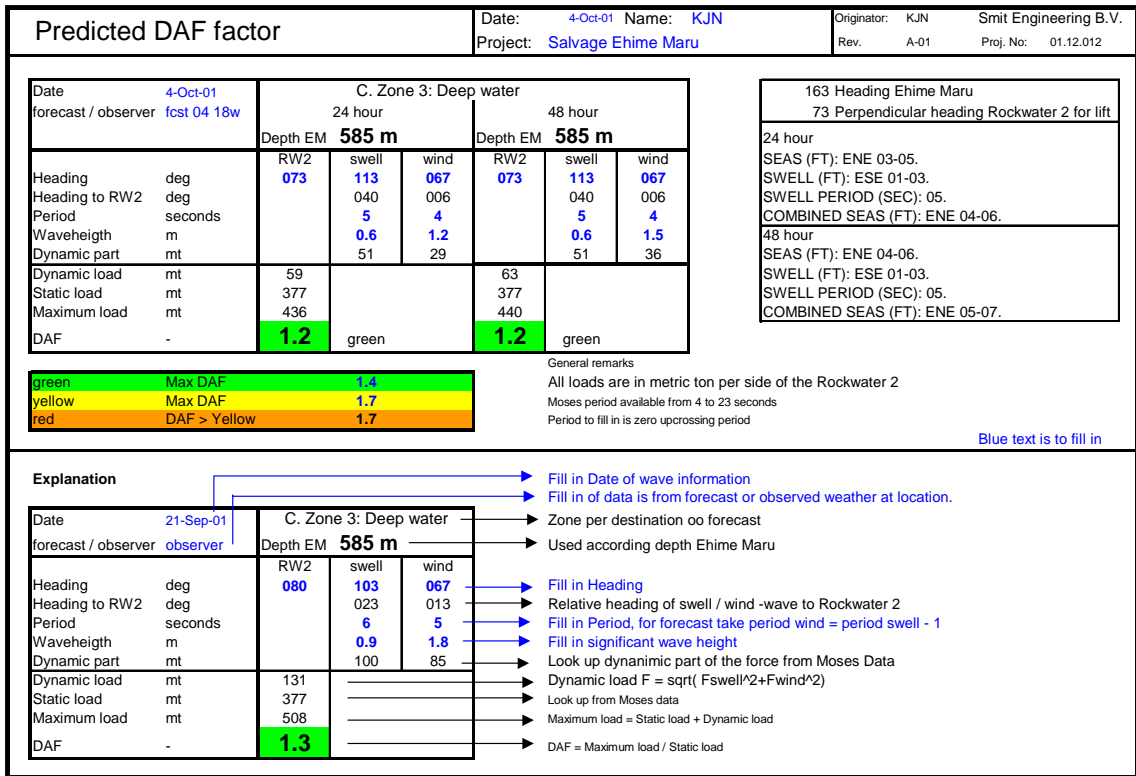

Figure 5-51. Dynamic Amplification Factor (DAF).

In Figure 5-51 predicted DAF for October 4, 2001 showing a DAF of 1.2, which was at a DAF level appropriate for lifting EHIME MARU as indicated by the 24 and 48 hour green criteria predictions.

Motion sensors were placed on ROCKWATER 2, EHIME MARU, and load cells to measure forces on the main lift wires. The load cells to measure tension in the primary lifting wires were fitted to the attachment of the wire ends. These measurements were analyzed through the same dynamic analysis program to aid in determining procedures to minimize any risks in lifting and transporting EHIME MARU.

On 12 October all conditions were right. At 0130 the lift commenced. When EHIME MARU was clear of the bottom, ROCKWATER 2 moved slightly away from the lift site to clear the sediment cloud. This allowed the ROVs to inspect, for the first time, the bottom damage. As suspected, a 60-foot gash was found where the submarine rudder had penetrated the hull. Part of the keel was protruding below the hull, which explained why they had not been able to pull messenger wires from the stern to the bow section. Transiting with an armada of other support vessels, ROCKWATER 2 began its slow trek to the shallow water site. Figure 5-52 is an aerial view of ROCKWATER 2 located on the right

hand side of the photo with SUMNER leading the way and oil spill recovery systems following.



**Figure 5-52. ROCKWATER 2 and Support Vessels.**

Ensuring there were no undiscovered problems with the lift, the initial transit speed was set at 0.2-0.3 knots. Since ROCKWATER 2 was outfitted with a dynamic positioning system for navigation and station keeping, this low speed was achievable. The dynamic positioning system also allowed the ship's heading to be placed in the most favorable direction with respect to the seas in order to minimize ship movement. Once the team was comfortable with the lift arrangement, the speed was slowly increased to 0.5-0.7 knots. Speed was kept under one knot so that the dynamic loading on the lift system was minimized. The speed was also kept low so that EHIME MARU could be slowly raised or lowered as the bathymetry changed. EHIME MARU was only lifted about 20 meters above the sea floor to prevent major problems with ROCKWATER 2 if the rigging failed catastrophically, and in case EHIME MARU needed to be placed back down if any rigging problem developed.

The primary vessels accompanying ROCKWATER 2 during the transit to the SWRS were two Oil Spill Recover Vessels (OSRV) to recover any oil that might come to the surface, USNS SUMNER transiting ahead of ROCKWATER 2 to determine accurate real time depth measurements so that EHIME MARU could be kept just above the bottom, USS SALVOR, and JDS CHIHAYA (Figure 5-53).



**Figure 5-53. Primary Vessels Accompanying ROCKWATER 2 (Center) During Transit to SWRS.**

On 14 October, after completing the 14-mile journey, EHIME MARU was set down at the shallow water site without incident.

## 5.6 Phase V: Post-Lift ROV Survey of Deep-Water Site

Following the lift of EHIME MARU, a visual survey of the sea floor at the salvage site was conducted. The purpose of the survey was to ensure that all items of interest had been collected from the site. The Japanese Maritime Defense Force vessel CHIHAYA used an ROV to inspect an area of approximately 1,000 yards by 1,000 yards around the DWRS.

## 5.7 Phase VI: Crewmember Recovery

The next phase of the operation was to use divers to search for and recover the missing crewmembers and other items sought by their families. The diving operations began on October 16, 2001 and were completed on November 21, 2001. There were five tasks identified for the divers to complete during Phase VI. The tasks included:

- Recovery of Crewmembers aboard the EHIME MARU
- Collecting Personal Effects of the Crewmembers
- Recovery of Unique Shipboard Items
- Performing Hazardous Liquids and Material Mitigation Actions
- Rigging the Lift Assembly Connections prior to Final Relocation



### 5.7.1 The Dive Team

Commanding Officer, Mobile Diving and Salvage Unit One (MDSU1) directed the international dive team that participated in the crewmember recovery. The dive team included Surface Supplied and SCUBA divers from:

- MDSU 1
- USN Ship Repair Facility (SRF), Yokosuka Japan
- USN Submarine Training Center, Pacific
- USS SALVOR
- Explosive Ordnance Disposal Mobile Unit 3 (EODMU 3)
- Explosive Ordnance Disposal Mobile Unit 11 (EODMU 11)
- Japanese and Japanese Maritime Self Defense Force (operated off CHIHAYA independently)
- Combat Camera (operated off the 450-10 independently)



**Figure 5-54. Japanese Surface Supplied Diver.**

MDSU 1 provided the majority of the divers and developed the detailed dive plan that guided all diving efforts and directed the diving effort.

SRF Yokosuka provided Japanese divers who work for the U.S. Navy and are authorized by an OPNAV waiver to dive with USN divers and systems. Four of their divers supported the mission. While one of the SRF divers was in the water, the other was at the communications console. They played an important role in the dive operations by identifying spaces through the divers' camera topside monitor.

Japanese Maritime Self Defense Force divers operated with their own equipment off the CHIHAYA and dove the EHIME MARU for seven days between November 7 and November 14, 2001. The purpose of these dives was to do a final sweep of the ship and surrounding area in search of the 9th missing crewmember and significant personal effects. Unfortunately, the last crewmember's remains were never located.

Combat Camera divers operated as a separate entity and provided underwater documentation of the dive operations.

In preparation for conducting the working dives on the vessel, the surface supplied divers performed familiarization dives at the shallow water recovery site before EHIME MARU arrived. This provided them with information about the overall dive and bottom conditions. They also toured the sister ship of EHIME MARU when she was docked in Honolulu, in order to be more familiar with the access to the various compartments on EHIME MARU.

Recognizing the sensitivity of the recovery of the remains of the victims, and significant differences on the cultures of the U.S. and Japan, the MDSU divers were given special cultural awareness training in preparation for the recovery operation.

There was a very detailed medical plan that defined the transfer and treatment of divers, topside personnel and the recovery victims in a COMNAVSURFGRU MIDPAC medical tasking message located in Appendix E, Correspondence.

During the planning phase of the dive operations a Remediation Table was created to provide operational guidance for potential challenges that could have an effect on the progress of the dive operations. Table 5-1 outlines six potential problems that could have impeded progress of the dive operations and provides the prospective solutions.

PROBLEM	SOLUTION
High rate of Decompression Sickness (DCS)	Work with Dive Medical Officer (DMO) to increase decompression to reduce DCS
Individuals unable to cope with the task of recovering remains	Individual transported to shore. Will receive counseling from trained professionals at hospital.
Space unable to be accessed	Hydraulic tools will be used to help gain access
Storm approaching	If required, barge will be moved to safe harbor
Medical injury	Initial actions performed by DMO. If serious, will be transported to hospital by small boat or life flight
Remains not found	A thorough inspection with video documentation will prove that victims are no longer in vessel

**Table 5-1. Dive Operations Remediation Table<sup>1</sup>**

In accordance with *U.S. Navy Diving Manual*, a minimum of eight divers is required to operate a surface supplied diving system when using more than one diver. This operation required two surface-supplied diving systems in use simultaneously for a minimum of 16 divers per shift. This did not include the personnel required for the decontamination station, recompression chambers, stage handling, topside camera systems, winch operators, medical personnel, etc.

<sup>1</sup> 4/09/01 Correspondence from Master Diver Davidson, 00C34 to CAPT Marsh, 00C Subject: Phase VI-Crewmember Recovery.

The minimum number of personnel for the dive operations included:

- 8 primary dive station
- 8 standby diver dive station
- 2 surface decompression chamber operators
- 2 decontaminated station personnel
- 2 stage handlers
- 1 topside camera operator
- 1 winch operator
- 1 diving medical officer
- 1 extra

---

26 Total

### **5.7.2 The Dive Platform**

The Crowley 450-10 accommodation work barge not only served as an excellent dive platform but also doubled as the transport vessel, moving EHIME MARU from the SWRS to the FRS (Figure 5-55). It provided power, water, mooring gear, cranes, galley and berthing for 80 personnel. It also held storage tanks for diesel fuel and lubricating oil that was pumped from EHIME MARU in the later stages of the dive operations. The CMC 450-10 was positioned over EHIME MARU so the divers could be lowered directly to their workstations on the ship. The goal was to give the divers the ability to efficiently access the vessel. A six-point moor for the CMC 450-10 was set in order to assure a stable dive platform and allow for repositioning to accommodate dive requirements.

The initial SCUBA dive was performed 24 hours after EHIME MARU was placed at the SWRS. The divers waited 24 hours to assure that the vessel was stable. They placed inclinometers onboard to measure the inclination of the vessel to double-check its stability. Once the inclinometers were placed onboard it would be a full 48 hours before the surface supplied dive operations commenced.

EHIME MARU was resting on her keel in an upright position in approximately 115 feet of water. The inclinometers revealed the ship was listing to port 2.5 degrees and down by the bow 4.9 degrees.



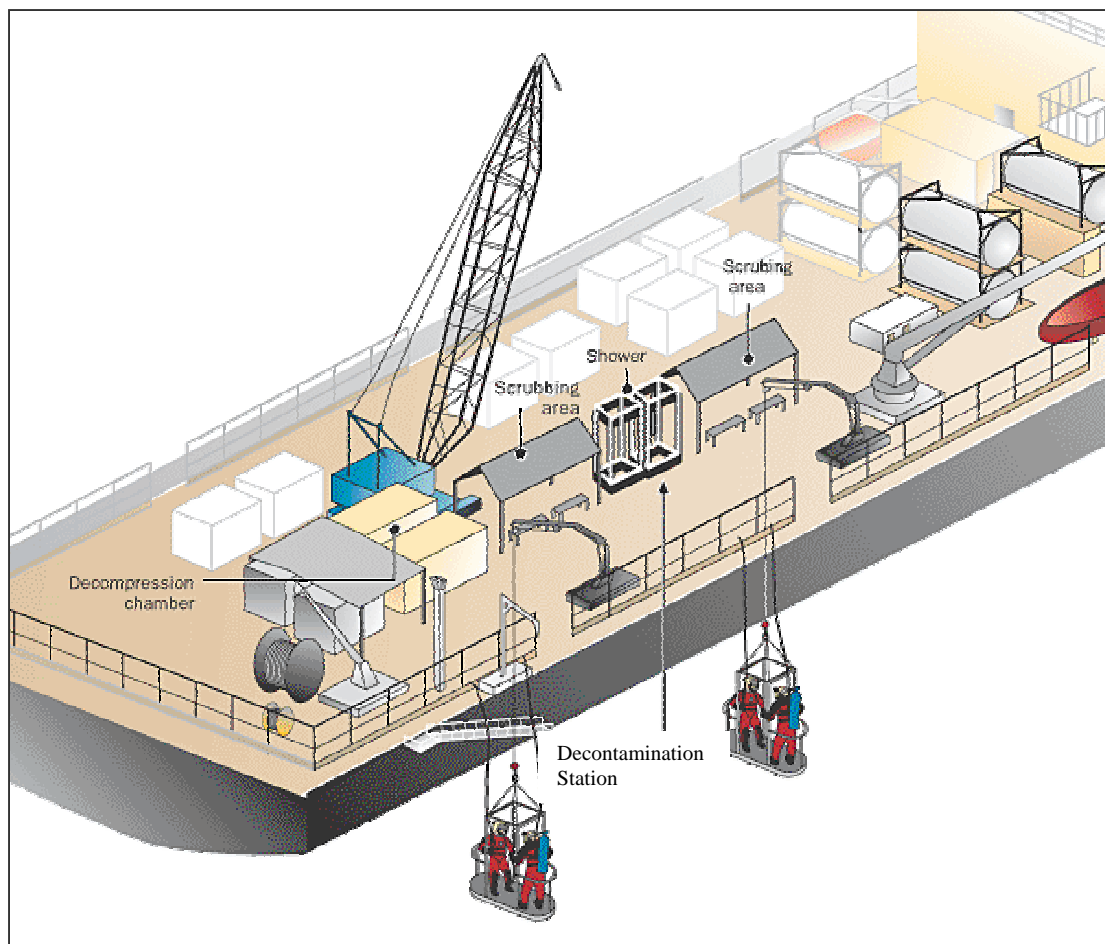

**Figure 5-55. CMC 450-10 Dive Platform (Courtesy of Honolulu Advertiser).**

Ladders were affixed to the side of the ship to allow divers to access the main deck of the ship from the ocean floor (Figure 5-56). Although some work was done to clear the ship of hazardous fishing line prior to moving EHIME MARU from the DWRS to the SWRS, the first SCUBA dive on the vessel revealed tangled fishing line shrouding the upper deck. Paramount to the safety of the surface supplied dive operations was to assure the ship was not shifting in the SWRS, that the decks were cleared of hazards and that there were easily accessible entry points for the dive teams. The first dive on the vessel required removing the line and assuring safe access to entry points on the vessel.

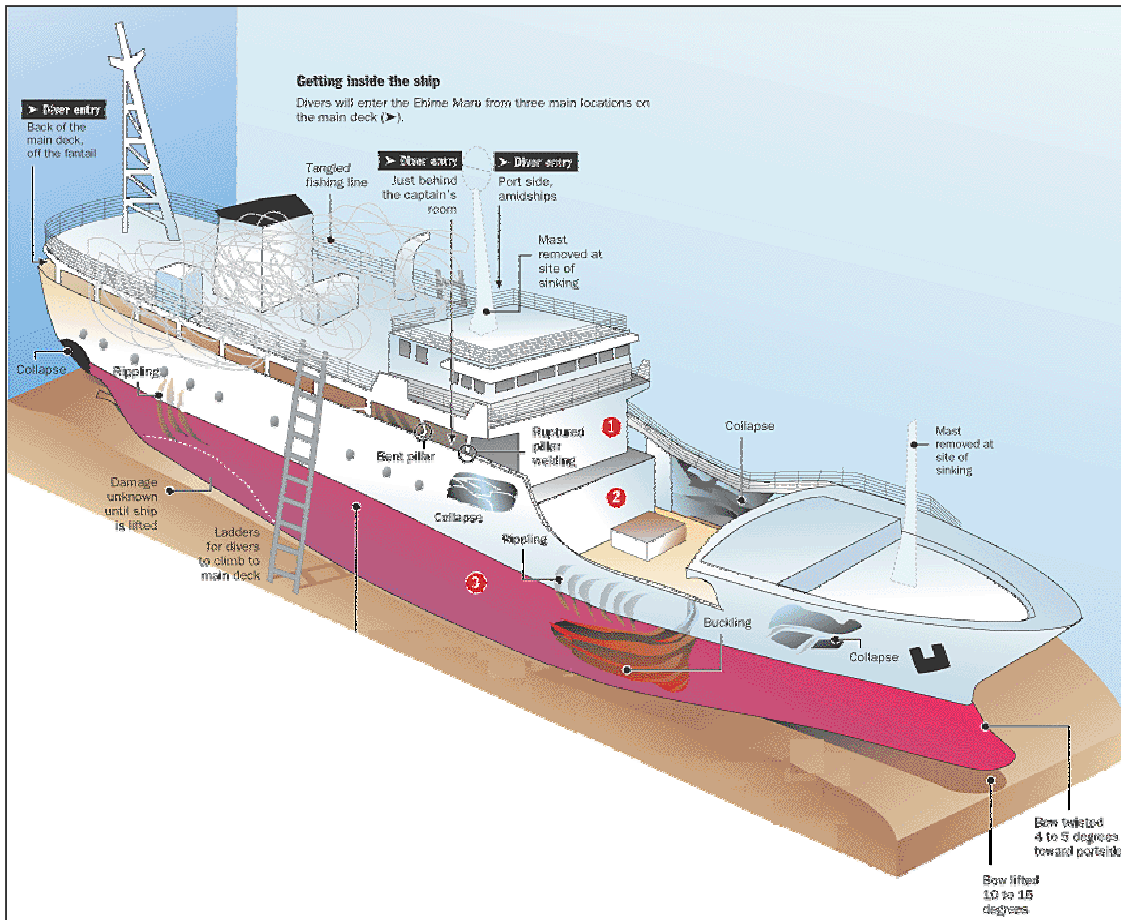

Figure 5-56. EHIME MARU at the Shallow Water Recovery Site (Courtesy of Honolulu Advertiser).

### 5.7.3 Dive Systems and Equipment

The dive profile for the EHIME MARU recovery site necessitated both in-water decompression as well as surface decompression requiring oxygen. This allowed for the maximum amount of time for each dive team to work on the vessel, and the minimum of time spent decompressing in water. The majority of decompression time was conducted topside in a recompression chamber, under controlled conditions. There were two recompression chambers onboard the CMC 450-10; a Transportable Recompression Chamber System (TRCS) and a Fly Away Diving System III (FADS).

The FADS Dixie Double Lock chamber was considered the secondary chamber and the emergency chamber for treating potential Arterial Gas Embolisms (AGE) and Decompression Sickness (DCS).

The TRCS was used as the primary chamber and used for decompression following the dives (Figures 5-57 and 5-58). The chamber consists of the main body, which is cylindrical in shape, and a smaller shaped Transfer Lock. The Transfer Lock (TL) is designed to transfer people, normally medical personnel, in and out of the TRC. The two vessels, TRC and TL, are connected by a freely rotating NATO flange coupling. For U. S. Navy Divers, if further care were needed, beyond the scope of the DMO, the injured diver would have been treated at Tripler Army Medical Center.

CHIHAYA Dive Medical Officer medically treated Japanese Maritime Self Defense Divers. If further care were needed they would have been transported to Tripler Army Medical Center in accordance with the Status of Forces Agreement.

A significant safety concern with the diving operations aboard EHIME MARU was the presence or release of diesel fuel and the possible contamination from exposure to decomposed human remains during the dive. Divers wore drysuits to protect them from these potential contaminations. There was a decontamination area onboard the barge. Prior to the dive operations, divers designed and manufactured a first of its kind decontamination shower station. Once topside the divers proceeded to the shower for scrub down, and then went back to their benches to undress prior to entering the recompression chamber. The purpose of the decontamination area was to clean the divers of any contaminants immediately after each dive in preparation for entering the recompression chamber for surface decompression. There was a crew dedicated to cleaning the divers at the decontamination shower station. They had to move fast to undress and clean the divers in three minutes and to get them in the chamber following the decontamination procedure.



**Figure 5-57. Transportable Recompression Chamber.**



**Figure 5-58. Transportable Recompression Chamber System (TRCS).**

The 115 feet of water at the worksite required the divers to use a Surface Decompression Table (SUR D O<sub>2</sub>). Some dives were around 100 feet when they were working on upper decks. Based on this, divers had between 60 and 90 minutes of bottom time with 7 minutes of in-water decompression. With quick turn around times, the maximum amount of dives possible in a 12-hour shift was six. Many of the dives were in depths from 110 feet to 120 feet depth. Figure 5-59 shows a representative example of how much time is involved in a 90-minute dive shift. Three hours are dedicated to the dive and surface decompression time for each of the divers at this depth.<sup>2</sup>

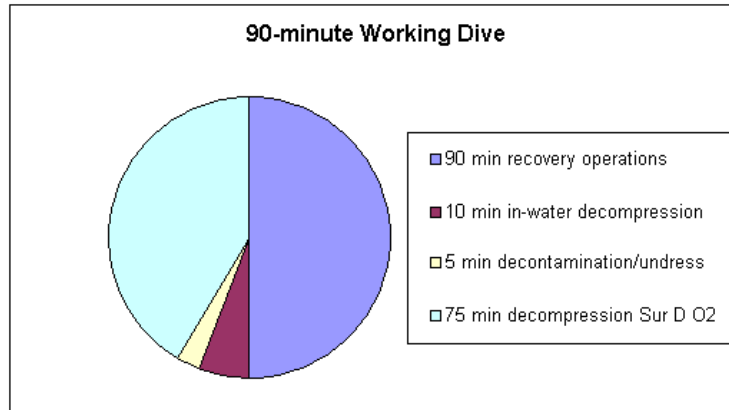

Figure 5-59. Diver's Work Shift for 110'-120' Dive.

The main dive equipment utilized on this job included:

- Light Weight Dive System (certified to 190 FSW)
- MK-21 surface supplied dive hats with SCUBA bottles
- Helmet-mounted camera
- Helmet-mounted light systems
- Communication boxes
- Salvage basket for victim transport through water column
- 4 each 300-foot umbilical hoses
- 5 each 600-foot umbilical hoses
- Dive stage



Figure 5-60. Red, Green, and Yellow Divers Being Lowered on the Stage.

<sup>2</sup> Representative numbers taken from Table 9-9: Surface Decompression Table Using Oxygen from the U.S. Navy Dive Manual Revision 4.

### 5.7.4 Dive Operations

Forty-eight hours after the SCUBA divers placed inclinometers on EHIME MARU to ensure she was stable, the surface supplied divers began their difficult task of searching for and recovering missing crewmembers and their personal effects. Clearing the debris was the first order of business. When the divers entered the vessel they found the bulkheads and overheads full of debris, blocking safe entry to nearly all passageways. Following the extensive debris removal, the passageways were cleared so that deeper penetrations were possible. Recovery operations took place on all decks of the vessel. Each movement to a new deck was planned, and orchestrated in an organized fashion to ensure maximum diver safety.

1. From the main deck, the Red diver, tended by Green diver, enters second deck and proceeds to the entrance to the third deck.
2. Tended by yellow diver, Green diver then proceeds to the second deck to tend Red diver.
3. Red diver enters third deck tended by Green diver. Yellow diver tends Green diver.

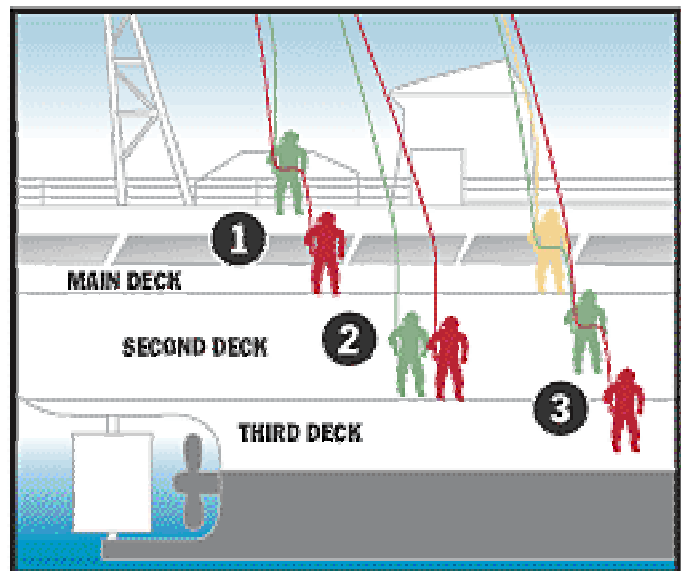

**Figure 5-62. Red and Green Diver (Courtesy of Honolulu Advertiser).**

Working under low to no visibility conditions, they searched every compartment of the ship for the missing crewmembers. Inspecting, recovering, and documenting were the main activities. The initial inspection was conducted on last known locations of the crewmembers. Remains and personnel affects encountered were collected and removed to the surface. An extensive search of every space was conducted and documented on videotape. Each space was marked and numbered to avoid confusion on subsequent dives with multiple divers. Each dive began where the previous dive ended. Following each dive there was a topside de-brief and the ship's drawing was marked as to the position of the divers in the last dive, allowing for a visual pre-dive brief for the next dive team. The search continued until all spaces had been entered and thoroughly examined. The helmet-mounted camera and light system was connected to a topside video recorder and monitors for the



## F/V EHIME MARU Recovery and Relocation Report

diving supervisor, the SRF Japanese diver, as well as Japanese VIPs to observe the entire search as it progressed.

During the crewmember recovery phase, NAVSEA provided personnel and equipment to perform periodic surveillance overflights to ensure that the environment was protected. Additionally, they maintained one vessel-mounted dispersant spray system on site. One Skimmer system was located on site for the initial survey period and retained as required. A second Skimmer system was in ready standby at Pearl Harbor. Two helicopter dispersant bucket systems were in ready standby in Honolulu. There was a slight sheen that emanated from the wreck, when the ship was initially placed at the SWRS, prior to commencement of diving. This required the use of oil spill clean up equipment to mitigate the effects of the released oil. Both ESSM and local response contractors engaged in the clean up. GPC deployed an ESSM oil spill boom to contain the sheen and a skimmer system to recover it. Very little oil was recovered and there was no known impact on any of the nearby beaches.

Following the recovery of missing crewmembers, divers began to collect personal effects and ship's items. Divers searched all decks and cleared over 120 compartments. The ship's helm, bell, and anchors were recovered as memorial artifacts. Certain family members requested that unique items that the missing crewmembers used to perform their shipboard duties be removed. These included such items as radio equipment and engineering control

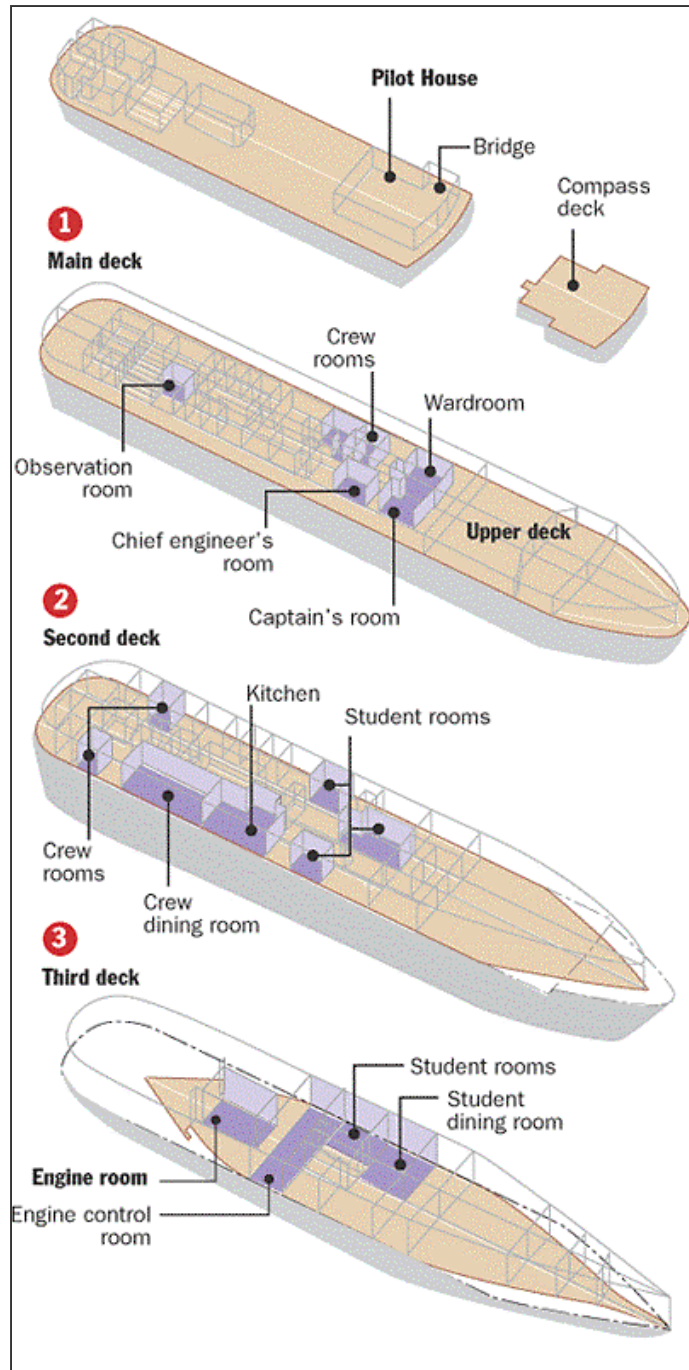

Figure 5-63. EHIME MARU Layout (courtesy of Honolulu Advertiser).

handles. Figure 5-63 shows the layout of EHIME MARU and the spaces the divers searched.

There were only two significant breaks during the diving operations. One 24-hour break occurred on October 30 when it was noticed that the dive site was unsafe due to a corroded connector to the spreader assembly. MDSU did the inspection of the block pin assemblies and torque boxes using the hand tool provide by SMIT. Based on this inspection they determined that one assembly required new bolts and the other assembly required repairs. The connection was replaced within the 24-hour period and dive operations resumed.

One other break in dive operations occurred on November 7, 2001 when the CMC 450-10 was moved from the dive site to allow CHIHAYA to move into place and have the Japanese divers make one final sweep of the vessel and the surrounding area for the missing crewmembers. They dove for seven days and did not find the final missing crewmember. Following their dive operations CMC 450-10 moved back into place to prepare for the lift and transit to the Final Relocation Site.

After 37 days and 650 dives, the divers had successfully recovered 8 of the 9 missing crewmembers as well as over 2,500 personal items for return to family members. Despite the disappointment of not being able to recover the 9th body, the dive operations were successful and were performed without incident.

## **5.8 Phase VII: Preparation for Relocation and Release at Deep-water Site**

The final phase of the operation was to place the ship back in deep-water beyond the 1,000 fathom curve.

The initial task in this phase was to remove any remaining fuel and lube oil from EHIME MARU to prepare for the final relocation. The method used for offloading oil was to utilize divers to access tanks through vents and pumping to the support barge. Where necessary, ESSM hot tap systems were used to access tanks through tank tops and sides to increase accessibility.

During this phase, NAVSEA provided periodic surveillance overflights to detect any spill. A skimming system was retained on site during the entire oil removal process and accompanied the vessel during the transit offshore. A second skimming system was retained in ready standby at Pearl Harbor throughout the process. Two helicopter dispersant bucket systems were in ready standby in Honolulu and full logistic support was provided.

## F/V EHIME MARU Recovery and Relocation Report

Due to the cost of leasing ROCKWATER 2, it was decided that the diving support barge provided by Crowley Marine would be used as the hoist platform. The method was to use the Crowley 450-10 through a ballasting procedure to lift and transport EHIME MARU to the relocation site.

The barge was prepared by the installation of four lifting padeyes to the transom. The barge ballasted down approximately 14 feet to a draft of 20 feet at the stern while moored directly over EHIME MARU. Two lifting plate assemblies constructed for the lift were used to connect to the upper lifting assembly. The lifting assembly was lowered back to the lower assembly, this time utilizing 4-inch, Grade 3 chain instead of wire rope. Divers attached the upper lifting assembly to the lower one. Navy divers flooded the lower assembly buoyancy system and rigged thermal cutters on the slings to release EHIME MARU from the lifting assembly.

Once divers were clear of the water and weather/sea conditions were acceptable, the slack was taken out of the lifting chains using deck winches and wire rope. Once all slack was out of the chains, the barge was deballasted, to return to its original draft. This lifted EHIME MARU clear of the sea floor for the transit to deep-water.

Two tugs were used to tow the barge/EHIME MARU to the relocation site, following the surveyed route. One tug ahead towed, while the other, connected to the stern of the barge, assisted in maintaining constant drag for control. A maximum speed of 1 knot was maintained. Figure 5-64 shows the stern line for maintaining control during the tow.



**Figure 5-64: Crowley 450-10 with EHIME MARU Suspended Underneath Being Towed to the Deep-water Relocation Site.**



The lift went without incident and EHIME MARU was successfully towed back to sea and laid to rest in 8,500 feet of water on November 25, 2001. JDS CHIHAYA accompanied EHIME MARU and CROWLEY 450-10 to the deep-water relocation site and the Japanese crew and the U.S. Navy Mobile Diving and Salvage Unit Commanding Officer rendered honors at the time of release.

The barge then was towed back to Pearl Harbor to demobilize the dive system and personnel, completing the operation.



**Figure 5-65. JDS CHIHAYA at the Deep-Water Relocation Site.**

**This page was intentionally left blank.**

## *Chapter 6*

# **Lessons Learned**

Lessons Learned focuses on the successes of the operation as well as the challenges and problems encountered during the operation. The EHIME MARU recovery and relocation project was a major salvage and diving operation that presented multiple challenges including: political sensitivity, cultural differences, state, federal, and public environmental concerns, weather driven schedule, multiple assets from multiple organizations, depth of the working environment, and the size of EHIME MARU. The probability of success was considered 80%, and because of the strong commitment and desire to recover the bodies of the crewmembers, this was considered sufficient to make the decision early to commit to accomplishing the task.

### **6.1 Commitment of Platforms**

During the initial planning for the operation, SMIT identified a support platform that was ideally suited for the operation. However, the approval to proceed with the operation could not be granted until the EA was completed. Because deep ocean construction ships are in high demand and the worldwide inventory is very limited, while awaiting the approval, that ship was chartered for a long-term offshore construction project. Fortunately, ROCKWATER 2 was just completing a project in the Philippines and SMIT was able to hire her. Significant modifications had to be made, and ultimately the cost exceeded what the cost for the original ship would have been, but ROCKWATER 2 proved up to the task.

Although this situation could not be avoided, it demonstrated the importance of timely decisions to authorize and fund critical salvage operations.

### **6.2 Use of Foreign Flag Vessels**

During the initial planning of the operation it became obvious that exclusive use of U.S. flagged vessels would not be possible. Although there are construction platforms in the U.S. inventory, there were none available that could complete the tasks required. Both ROCKWATER 2 and CMC 450-10 are foreign flagged. To protect U.S. shipping interests, the Jones Act was passed to restrict foreign flagged vessels from shipping products from one U.S. port to another. ROCKWATER 2 would be bringing EHIME MARU from international waters to an offshore site in U.S. territory. This was not a violation of the Jones Act. However, our original intent was to use the CMC 450-10 to transport a

significant amount of equipment from Long Beach to Pearl Harbor to support the operation. Because of the Jones Act, the equipment shipped on CMC 450-10 could not be offloaded in Hawaii, and returned to Long Beach upon completion of the project. We had to work closely with the Coast Guard and Customs Service to develop a plan that would allow use of the barge without violating the Jones Act. Once again, the cooperative support from all parties lead to timely resolution of this issue.

Jones Act issues must be addressed as soon as it becomes apparent that a foreign flagged vessel will be employed in U.S. waters.

### **6.3 Environmental Assessment**

The requirement to complete an EA became important to the local community as well as interested state and federal government agencies. The process of developing the EA provided the opportunity to gather and share concepts and concerns with stakeholders and through doing so there was a strong commitment from each state and federal agency to work the issues as a team. Completing a thorough and well-written EA demonstrated the Navy's commitment to the environmental aspects of the project and fostered cooperation among the participating agencies. This cooperative effort was critical to the timely completion of the EA.

Once the EA was completed, it became the guidebook for the rest of the operation; there were minimal deviations from the plan expressed in the EA. This proved problematic at times. In some instances the EA was very specific and did not take the possibility of deviation into account. Because salvage operations can never be guaranteed to work exactly as planned, contingencies are generally included in the salvage plan and are often used to complete the project. When a contingency came up that was not addressed in the EA, some delays were encountered. Ultimately all worked out, but if the EA had included a flexible way of addressing contingencies, some issues could have been avoided. In hindsight we tended to view the EA as an environmental issue to resolve and should have included representatives from SMIT and Crowley on the EA team.

### **6.4 Planning and Tracking Progress**

Using software designed for managing complex projects enabled the salvage team to estimate the time to complete specific milestones as the project progressed toward completion. Although the timeline was critical, by focusing on the milestones, Admiral Klemm was better able to report progress, even when deviation from the timeline took place. Had he been focused specifically on the timeline, each time a deviation occurred he would have had to explain why.

The software allowed each member of the team to focus on his/her part of the problem and input updates to one individual who updated the main database on a daily basis. This was an excellent way of tracking the multitude of issues that came up during the conduct of the operation.

## **6.5 Assessment of EHIME MARU**

Although in this instance much of the major damage to the hull could not be seen, the video survey conducted by the ROV was critical to the feasibility assessment and salvage planning. By including a SMIT salvage engineer in the video survey team, he was able to have the ROV operators focus on items that he needed to see, which they might have not deemed significant.

Very detailed video survey, with technical guidance is critical to the operation and although time consuming and costly, it is time and money well spent.

## **6.6 Selecting the Team**

No one person could take credit for the planning and execution of this operation. The initial search and survey team, consisting of DSU, SUPSALV, Oceaneering, C-COMMANDO and SALVOR did an outstanding job locating and surveying EHIME MARU. The video survey proved to be invaluable to the SMIT and NAVSEA engineers who developed the feasibility study. The choice of these two teams was an excellent one that provided immediate response to this highly visible operation.

Because of the complexity of this project, SUPSALV did not rely on one source for the feasibility assessment. Rather, he directed SMIT to conduct one, and at the same time, convened a team of engineers from his staff, NAVSEA 05 engineers and the Japanese engineering team. Both teams evaluating feasibility ultimately came to the same positive conclusion, which provided significant credibility to the recommendation to proceed.

Teaming SMIT and Crowley to take on this project proved very effective. SMIT brought significant experience in heavy, deep ocean salvage. Crowley provided significant experience in operational logistics, diver support, transportation, and the ballast lift technique. Under the direction of SUPSALV, these teams worked well together, each recognizing the others strengths, and providing excellent support to one and other.

The EA team was a good example of multiple organizations working together to solve a complex issue. EAs have been known to take much longer to complete. Sea conditions in the Fall would typically exceed the safe working limits of the lift ship and dive

operations. That meant that the EA needed to be completed in time for the salvors to complete the operation by late summer. Choice of a contractor with extensive EA experience in Hawaii proved to be an excellent one. EDAW already knew the significant local, state and federal agencies and individuals to work the issue. All of the participating agencies provided excellent support for the project and the assessment was completed in record time.

The salvage team included some of the best and brightest salvors in the business. The salvage team included a large staff of salvage engineers, salvage masters, technicians, riggers and specialists who did an outstanding job developing a solid salvage plan with multiple contingency plans and material included in the original loadout. Ensuring that the offshore team included the technical expertise needed to revise plans, modify equipment and execute contingencies on scene was critical to success. The team must also include both a logistics support organization and technical support ashore to coordinate and provide all aspects of support needed offshore.

Including Japanese experts in the team provided many benefits. Obviously, this was the right decision as it allowed their full participation in the process, and they provided both critical knowledge of EHIME MARU and technical expertise. With their insight, expertise, and cultural perspective, they significantly contributed to the success of the operation.

As has been the case in other large-scale diving operations, the use of Navy divers provided a base of talented divers to support the operation. MDSU 1 was the logical choice for overall direction of the diving effort, with augmentation from other diving and salvage commands. Including Japanese divers from SRF provided MDSU with expertise in the cultural issues, layout of the ship and identification of items to be recovered. It also demonstrated to the Japanese government and the victim's families that the U.S. Navy was determined to do everything possible to successfully complete the operation.

## **6.7 Selecting the Equipment**

This operation required the use of very specialized equipment. The DSU SCORPIO and SUPSALV DEEP DRONE were used for the initial survey. They did an excellent job documenting the visible damage to the ship. However, neither of these systems was designed to take on the heavy work tasks that the salvage effort would require. Accordingly, SUPSALV tasked SMIT to provide heavy construction ROVs, equipped with the tools and power needed to complete the operation.

Utilizing their extensive experience in heavy salvage and working closely with the offshore industry, SMIT was able to locate and procure specialized equipment for this



unique operation. The linear winches were the only two of that size known to exist. The subsurface navigation was provided by a company that routinely provides that service to the offshore industry. A company that specializes in 3-D imagery provided the program and operators for that system. Much of the equipment utilized was never intended for deep ocean salvage work, but adapted from the offshore construction industry.

Selecting subcontractors and equipment that provided unique specialties provided the salvage team with the best technology available. This significantly added to the ultimate outcome of the operation.

## **6.8 International Visibility**

The international visibility was challenging at times. Admiral Klemm met with the Japanese contingent nearly every day to ensure that they were always aware of progress and problem resolution as required. While not a normal part of a salvage operation, this was extremely important and required significant high-level attention. The public affairs office did an excellent job ensuring that the Japanese were briefed on sensitive issues before they were released to the media. Ensuring that the international press organizations had access to current information was accomplished by use of the EHIME MARU website. This allowed immediate access to information, regardless of the time zone the organization was in. Keeping the information flow to families of the victims and the Japanese government open while managing the press was a delicate process that required a full-time, dedicated staff.

## **6.9 Cultural Sensitivity Training**

All of the U.S. dive team and several others associated with the crewmember and personal effects search and recovery phase were provided cultural sensitivity training through the University of Hawaii. This worked well to develop the positive rapport between the U.S. and Japanese teams. The respect the divers paid to the recovered remains and how they handled the body bags onboard the barge brought comfort to all involved, especially family members. Cultural awareness is a very important part of an operation of this nature.

## **6.10 ROV Visualization Technology**

The 3D real-time visualization technology used to display the locations and actions of the ROVs, lifting assemblies and EHIME MARU aided in the success of the deep-water work. At times during the deepwater phase of the operation the ROVs stirred up the bottom sediment, reducing the visibility significantly. The virtual images of EHIME MARU and the ROVs positions in real time provided the ROV operators the ability to visualize the operation and maneuver the ROVs. The 3D visual presentation also provided the ship's

bridge the information required to adjust the position of ROCKWATER 2 as needed to support the action-taking place 2,000 feet below. It also provided the project management staff a real-time picture of the work in progress. An additional benefit was that it provided the shore command very detailed and interesting briefing material.

Because of rapid advances in technology, it is difficult for salvors to know specifically what new technologies are available. The offshore construction industry is probably the best source for this sort of information. Salvors should always consider the fact that there are very significant technologies available that can significantly improve their ability to complete complex operations.

### **6.11 ROV Multiple Screen Viewing Technology**

There were several ROVs being use simultaneously for multiple tasks. By using a monitor capable of displaying multiple video inputs the ROV operators, salvors and Japanese engineers on board were able to constantly monitor progress. This significantly eased the complex task of coordinating the ROV operations.

### **6.12 Coiled-Tubing Drilling Technology**

The coiled-tubing drilling technology offers real promise although it was not successful in this operation. As a derivative method from the oil and gas industry for directional drilling, it provides the ability to position lifting wire or straps under the hull without stressing it.

While there will always be speculation as to why this system failed to perform as predicted, one modification could have been done that would have significantly aided in the process. It is entirely possible that the nozzle actually emerged from beneath the hull, but not exactly where we anticipated it. Because of its relative small size, it would have been difficult for the ROV to locate. If the nozzle had been equipped with an acoustic marker beacon or transponder, the navigation team would have been able to detect it acoustically and vector the ROV to it.

### **6.13 Real-time Meteorology and Oceanography (METOC) and Motion, Stress, and Strain Sensors**

Real-time input of meteorological data proved to be invaluable to the operation. It allowed the salvors to predict weather windows that would be favorable to their efforts. Having real-time information available during the actual lift segment was critical to the ultimate success.

The improvements in technology to model and predict the dynamics of the deep-water lift significantly aided in building confidence in the safety of the project and reduced the risks of a failure during the rigging, lifting, and transit operations. Utilizing real time input from motion, stress, and strain sensors, the crew of ROCKWATER 2 was able to adjust speed (from 0.2-0.3 knots to 0.5-0.7 knots) and heading during the transit to the Shallow Water Recovery Site (SWRS). This reduced the window of exposure to unfavorable weather conditions and allowed for adjustments to reduce the stress and strain caused by motion effects of the waves along the path.

#### **6.14 Communications**

Cell phones have become a vital part of our ability to communicate, especially for the onshore team and when within range, the offshore units. Because interception of cell phone transmissions is relatively easy, it is imperative that this issue be addressed at the onset of operations, and that guidance be provided to all participants regarding what, if anything, should not be discussed on cell phones.

Communications between the offshore units and the command center were critical to effective operations. In operations of this nature, alternate systems should be identified in event the primary goes down.

The use of dedicated personnel for communications was critical to maintaining a constant flow of information between the ship and command center. During this operation USN reserve personnel were used. Most of them were salvage officers, which made communications more effective, as they were better able to understand and explain the salvage terminology being transmitted.

#### **6.15 Public Affairs**

The use of trained PAO specialists is a critical aspect of any major operation. In this case, press interest was very keen, especially at the scene. By incorporating a dedicated PAO team on the command staff they were kept abreast of developments and able to keep the press informed as needed.

The PAO desk was adjacent to the salvage desk in the command center. Because the PAO officers were frequently on the phone with news reporters, it was difficult for the salvage officers to discuss sensitive information. While it is critical that the PAO officers have access to the activities in the command center, past experience has shown that their actual work spaces should be physically separated from the salvage operations command center. In the case of Space Shuttle CHALLENGER and TWA Flight 800 salvage

operations, the PAO officers worked in dedicated offices but participated in all daily briefs and were kept abreast of operational status. This worked well, allowing them to focus on PAO issues and the rest of the team to focus on the operational issues, without fear that the press would overhear sensitive information that should not be released.

## **6.16 Tracking Funds**

Each organization involved in this operation was directed to track their expenditures and report them to CINCPACFLT for potential reimbursement following the operation. Although this is probably the only way the Fleet can fund this type of operation, it did create problems for some of the activities that had very limited funds available for unanticipated travel and procurements.

NAVSEA was required to fund the majority cost of the operation, paying for the services of SMIT, Crowley and all of the other contractors and subcontractors involved. In order to track the cost and ensure that the contracts were always funded, as required by law, Richard Asher, SUPSALV Deputy Director had each contractor report expenditures on a weekly basis. This allowed him to monitor expenditures versus available funds, adjust funding on contracts, and if necessary, obtain additional funding from the NAVSEA Comptroller. Because initial funding is provided to cover estimated cost, as the actual cost become known, they must be reported so adjustments can be made to the total estimated funds needed to complete the project. This is critical in operations of this magnitude, where cost run into the millions. Consideration should be made to have the prime contractors provide an individual whose primary function is to manage funding issues.

## **6.17 Support Platform Characteristics**

Choosing the right platform for the mission is critical to overall success. In this case ROCKWATER 2 and CMC 450-10 were both ideally suited for the operation. ROCKWATER 2 provided a stable platform equipped with heave compensated crane, deck crane, dynamic positioning, sophisticated communications systems, berthing and messing for the large salvage crew, and deck space for all of the specialized equipment that was required for the operation. Had a lesser ship been selected, the initial cost might have looked attractive, but in the long run, deficiencies would have resulted in significantly greater costs, and the overall operation might have failed.

The CMC 450-10 provided a stable platform for the divers to work, berthing and messing for the large dive team, multipoint mooring for adjustment of position over the dive site, and deck space for all of the dive systems oil offloading systems used for the operation. Taking advantage of the ballast system on the barge and modifying the stern to accept the

EHIME MARU lifting hardware realized a significant cost savings. This meant ROCKWATER 2 could be released from the operation upon arrival at the SWRS, and a second lift platform did not have to be mobilized.

### **6.18 Contingency Planning**

Contingency planning is a critical part of all salvage operations. With large-scale operations, involving expensive support platforms, large crews and intense scrutiny from both the supported Commander and the public in general, it is imperative that multiple layers of contingency plans and the hardware to support them are in place. SMIT did an outstanding job ensuring that the salvage crew included the technical expertise to adjust plans on the spot. Additionally, they included a large inventory of contingency hardware, knowing that there were bound to be failures in both the hardware and in the application techniques. This allowed the operation to continue with minimal delays and contributed directly to the ultimate success of their effort.

### **6.19 Use of Reserve Support**

The use of reserve personnel significantly reduced the impact on the limited CINCPACFLT and SUPSALV staffs. Reservists who specialized in press relations augmented the CINCPACFLT PAO office. This was critical to the PAO effort. Reserve salvage officers provided SUPSALV with the onboard communications team on ROCKWATER 2. This relieved the onboard salvors from that duty, and provided communicators familiar with the salvage plan, terminology, etc. In both cases, this operation provided significant training in their specialized fields.

### **6.20 Documentation**

Documentation is an important part of all salvage and diving operations. Detailed description of the incident, the plan, techniques and equipment used, problems encountered, and lessons learned are all very valuable tools for salvors undertaking salvage operations in the future. In a simple, routine operation the salvage officer can sit down after the operation is finished and use his notes, deck logs, messages and other documentation to write the salvage report. In complex operations it should be done as the operation unfolds. In this case, we should have included an individual in the salvage team with the responsibility of gathering all of the data needed to document the entire operation, as it played out. We didn't do that. Instead, we relied on copies of messages, notes and memory. While we covered most of the critical aspects of the operation, we could have, and should have done better.

This lesson has been learned in the past, but in the heat of the moment, it was overlooked.

## **6.21 Lessons Learned by Contractors**

The critical success factors and the weaknesses of the project are described below as noted by contractors.

Critical success factors:

- Dedicated and flexible integrated (SMIT, SUPSALV, subcontractors) project team operating worldwide
- Flexibility in equipment and method (sufficient for two different recovery methods)
- Persistence (even in case of no success, being able to develop alternative methods)
- Multiple ROV support activities combined with 3D survey
- Innovative recovery method/lifting frame design
- Concurrent engineering practices (design/fabrication, methods/equipment).

Weakness:

- Design of clump weights: not designed for being recovered together with frame (suction resulted in collapse of beams).

In addition to the above, a summary of lessons learned from the evaluation report on this project is provided below:

In the first week on site the survey equipment caused some delay, as it did not work optimally. After thorough investigations it appeared that the system was affected by unknown external acoustic interference. Therefore any kind of external acoustic or seismic noise should be avoided during sensitive underwater operations where survey equipment plays a critical role.

Due to a thorough planning in Rotterdam, and by constant reviewing of our plans, we were able to make the recovery method of EHIME MARU watertight.

The sheaves on the clump weights should have been installed in the center of the clump weight instead of eccentric, as we pulled the 25-ton clump weight out of the seabed with 15 tons.

The winch hired from SMETCO was an unsafe piece of equipment, despite the fact that this winch fulfilled all requirements for offshore standards. The winch needed constant air pressure for the controls, brakes, and clutches. In case of a pressure loss, the dogs would go to a release position instead of lock position. The sudden uncontrolled reel down of the



winch, during our project, was a combination of bad maintenance by the suppliers of this winch and inadequate design.

The combination of the storage reels with the linear winches was very sensitive for operator errors, as they were not synchronized. In future operations the storage reel and winch should be synchronized.

The underwater hydraulic power unit worked well as it was able to fulfill a multifunctional task, and it appeared to be a very reliable tool.

There was a shortage of rigging personnel on site, as the workload for the (subsea) rigging works had been under estimated, due to regular changing and adaptation of the existing work plans.

The presence of a Naval Architect onboard was beneficial as he dealt with the work out of several changes in the plan and continuous technical queries from the Navy.

Personnel transfer with the crew boat appeared to be a risky operation. The personnel transfers were done in a later stage by helicopter. There were concerns about the quality of the helicopter used with respect to offshore landings and offshore helicopter regulations, as the helicopter was normally used for tourist trips around the island. A Navy or Coast Guard helicopter would have been a preferred option.

Despite the cramped time frame for design, production and mobilization, Lloyds was involved, and ran their calculations separate from our engineering team. This was very helpful.

The Delmar connectors appeared to be useful and are recommended for next remote subsea (heavy) lifting operations.

During the design phase of the project SUPSALV requested a large amount of spares for the ROVs, extra clump weights, wires etc. This has been very helpful when we were forced to deviate from the original plan, which took a lot more equipment than planned.

## 6.22 Recommendations

Problem: Skimmer System towlines parted while being towed in V-configuration by commercial boats in rough seas.

Recommendation: Due to rough seas and the higher freeboard of the commercial boats, the length of towlines should be increased to reduce the sharp angle of the line over the stern of the boat. Also, added chafing material should be installed to protect the towlines as they go over the stern.

Problem: Skimmer boom towing plates separated during operation. Operators attempted to make a sweeping turn with the boom open in rough

## F/V EHIME MARU Recovery and Relocation Report

seas. The combination of the sea conditions and the added stress of open booms exceeded the tensile strength of the aluminum towing plates at the point where they were welded. The tow plates that separated were the ones that had been welded to the smaller plates used with the older FUG boom.

Recommendation: Skimmers should not be deployed in the sea conditions that existed at the time. Boat operators must be instructed to close the boom before attempting to make turns in rough seas. The tow plates should be constructed of one-piece material to eliminate the single weld between the two plates.

Problem: The inflatable bows section of the 22' and 24' Rigid Hull Boats were damaged by operators bumping into the Barge 450 and into the pier.

Recommendation: None. Operational conditions of the mission were difficult and boat damage was due to working in those conditions.

Problem: Compartments within EHIME MARU would become pressurized from the divers' exhausted air. This in turn would displace fuel and oil suspended within the compartment. The displaced product would then bubble to the surface as sheen.

Recommendation: The divers pumped fuel out of the compartment using an ESSM provided wand connected to the peristaltic pump on the Barge 450. This action greatly reduced the amount of fuel reaching the ocean surface.

## *Chapter 7*

# **Conclusion**

Because of the success of this operation, people may have a tendency to overlook the magnitude of the accomplishments of all those involved. The initial ROV survey provided the salvage engineers with the data needed to conclude that successful salvage was within their capabilities. Planning for the operation and including multiple layers of contingency plans was, as always, a key factor. The detailed plans developed by SMIT and Crowley were superb. The Environmental Assessment, a relatively new requirement for salvors, provided local and federal agencies, and the public, confidence that the operation could be done with minimal threat to the environment. The MDSU 1 dive plan was one of the most complex dive plans ever developed by Navy divers. It covered all aspects of the search and recovery, safety measures, and contingencies. By following it to the letter, the dive operation was highly successful with minimal problems and no significant injuries.

Establishment of a shore based command center, provided the Fleet with a professional team equipped to resolve complex logistics issues, sensitive and critical press relations, legal and environmental issues, communications, and a host of other technical issues. This allowed the salvage and diving teams to focus on the technical aspects of the operation.

The equipment used for this operation was a mixture of USN and commercial salvage, diving and pollution abatement systems. Many non-salvage systems and techniques were adapted from other technologies, some from other governmental agencies, others from the offshore construction industry. While not all of the systems or techniques worked as predicted, they all give future salvors ideas and concepts to consider. Some of the key decisions and new tools or concepts included:

1. Balancing the mission requirement to recover remains and artifacts from EHIME MARU without injury to recovery personnel or damaging the Hawaiian environment with the overall plan to lift, transport to a shallow dive site then search with a combined USN and Japanese dive team was key to the success of the mission.
2. The attempt to pass messenger wires under the damaged hull using a coiled-tubing drilling unit was not successful. In retrospect, the decision not to include telemetry on the coil tube based on the land based test and operator experience was wrong. With a fully instrumented tube, locating its tip when it surfaced on the ocean floor could have allowed passage of the messenger wires without lifting the damaged hull. This would have accelerated the project by a month. To rig a severely damaged structure for heavy lift at excessive depths, this technique has a great deal of merit despite its failure on this project.
3. The combination of using the MOSEST<sup>TM</sup> program (Multi-Operational Structural Engineering Simulation) to predict the anticipated dynamic amplification factors, installation of a load cell in the pin arrangement for the lift wires on

## **F/V EHIME MARU Recovery and Relocation Report**

ROCKWATER 2 to give realtime data on wire loads, and the use of a fully dynamically positionable vessel resulted in a safe transit despite nearly doubling of the 700-ton lift while en route to the beach.

Major salvage operations of the future will differ from this one in many respects, but the thorough planning and preparation, coupled with precise execution will always be significant elements. The overall success of the operation is directly attributable to the Supervisor of Salvage and Commanding Officer of MDSU 1 and their staffs, the Salvage Master and engineers from SMIT and Crowley, the Command Center established by RADM Klemm and all of the other military, civil service and civilian personnel involved in the operation. The dedication and perseverance of the entire team cannot be overstated. They were superb!

## *Appendix A*

# **Acronyms and Abbreviations**

ADM	Admiral
AGE	Arterial Gas Embolism
ARS	Auxiliary Rescue and Salvage
CAD	Computer-Aided Design
CG	Coast Guard
CINCPACFLT	Commander in Chief, U.S. Pacific Fleet
CINCPACFLTINST	Commander in Chief Pacific Fleet Instruction
CNO	Chief of Naval Operations
COMSURFGRU MIDPAC	Commander Naval Surface Group, Middle Pacific
CTD	Coiled Tube Drilling
CTD	Conductivity, Temperature, Depth Measurements
DAF	Dynamic Amplification Factor
DCS	Decompression Sickness
DODINST	Department of Defense Instruction
DSU	Deep Submergence Unit
DWRS	Deep Water Recovery Site
FRS	Deep Water (Final) Relocation Site
EA	Environmental Assessment
EMCC	EHIME MARU Command Center
EOD	Explosive Ordnance Disposal
ESSM	Emergency Ship Salvage Material System
FADS	Fly Away Diving System
FONSI	Finding of No Significant Impact
ICS	Incident Command System
MDSU	Mobile Diving and Salvage Unit
METOC	Meteorology and Oceanography
NAVSEA	Naval Sea Systems Command
NAVSEA 00C	SUPSALV
NAVSEAINST	Naval Sea Systems Command Instruction
NDSA	Naval Defense Sea Area
NOAA	National Oceanic and Atmospheric Administration
OPORD	Operational Order
PAO	Public Affairs Office
RADM	Rear Admiral
ROI	Region of Influence
ROV	Remotely Operated Vehicle

## **F/V EHIME MARU Recovery and Relocation Report**

SITREP	Situation Report
SRF	Ship Repair Facility
SUBDEVRON 5	Submarine Development Squadron 5
SUPSALV	Supervisor of Salvage
SWISS	Shallow Water Intermediate Search System
SWRS	Shallow Water Recovery Site
TL	Transfer Lock
TRCS	Transportable Recompression Chamber System
TWA	Trans World Airlines
USCG	United States Coast Guard
USN	United States Navy

*Appendix B*  
**Mobilized Assets**

**Table of Contents**

Air Assets (MILITARY) .....	B-2
Ship Coast Guard Patrol Boat ASSATEAGUE.....	B-3
Ship: C-COMMANDO SSV .....	B-4
Ship: CHIHAYA ASR 403 .....	B-5
Ships: EHIME MARU and KAGAWA MARU (sister ship).....	B-6
Ship: KAIREI .....	B-7
Ship: USCGC KITTIWAKE (WPB 87316) .....	B-8
Ship: USS LAKE ERIE (CG 70).....	B-9
Ship: OCEAN HERCULES .....	B-10
Ship: ROCKWATER 2.....	B-11
Ship: USS SALVOR ARS 52.....	B-12
Ship: USNS SUMNER T-AGS 61 .....	B-13
Barge: Crowley Marine Services Barge CMC 250 .....	B-14
Barge: Crowley Marine Services Barge CMC 450-10.....	B-15
ROV: DEEP DRONE .....	B-16
ROV: KAIKO .....	B-17
ROV: MANTA.....	B-18
ROV: PHOENIX III .....	B-19
ROV: QUEST .....	B-20
ROV: SCORPIO II .....	B-21
ROV: XL-16.....	B-22





P-3 ORION



SH-60B Helicopter



HH-65



C-130

## Air Assets (MILITARY)

Air Asset	Organization	Base Location	Employment
P-3 Orion Airplane	USN Patrol Squadron Nine, VP four	Kaneohe Marine Corps Base, Hawaii	SAR
SH-60B Helicopter	USN Helicopter Anti-Submarine Squadron Light (HLS-37)	Kaneohe Marine Corps Base, Hawaii	SAR
HH-65 Dolphin Helicopter	USCG	Barbers Pt, Hawaii	SAR
C-130 Airplane	USCG	Barbers Pt, Hawaii	SAR



**Ship Coast Guard Patrol Boat ASSATEAGUE (WPB 1337),  
WASHINGTON (WPB 1331) & KISKA (WPB 1336)**

Description: Coastal Patrol Boat

Owner: U.S. Coast Guard

Features: Twin diesel engines, six-meter rigid hull inflatable, precise navigation system

Primary Assignment: Search and Rescue, CGC ASSATEAGUE assumed role as On-Scene Commander at search site. Throughout the operation the USCG assigned a safety zone enforcement craft for security purposes and during crewmember and personal effects transfer.

Length: 110 feet

Beam: 21 feet

Draft: 7 feet



## Ship: C-COMMANDO SSV

Description: Submarine Support Vessel

Owner: USN, Military Sealift Command

Features: Special Mission Ship under long term contract to MSC. Precision Navigation, Sonar capabilities, ROV Platform, crewed by civilians, under contract to MSC, generally supports submarine operations.

Primary Assignment: Support Vessel for ROV SCORPIO II during Phase 0.

Length: 220 feet

Beam: 56 feet

Draft: 16.5 feet

Displacement: 2,089 long tons



## Ship: CHIYAMA ASR 403

Description: Submarine Rescue Ship

Owner: Japanese Maritime Defense Force

Features: Capable of supporting ROVs carries a Deep Submergence Rescue Vehicle, Helicopter platform for up to MH-53 size, can also be used as a hospital ship. Precise Navigation

Primary Assignment: Platform and support vessel for Japanese Maritime Self Defense Force divers. Assist USN divers at the Shallow Water Recovery Site. Secondary assignment, assist in the survey of Deepwater Recovery Site once EHIME MARU has been relocated. Survey bottom for items of interest.

Length: 419 feet

Beam: 65.5 feet

Draft: 16.7 feet

Displacement: 5,400 standard tons





## **Ships: EHIME MARU and KAGAWA MARU (sister ship)**

Description: Japanese High School Fisheries Training Vessel

Owner: Uwajima Fisheries High School

Primary Assignment: Fisheries training vessels EHIME MARU subject of the operation KAGAWA MARU, (sister ship) was toured by U.S. Navy divers prior to the dive recovery operations on EHIME MARU.

Length: 191 feet

Beam: 18 feet

Draft: 7.5 feet

Displacement: 750 Tons (light ship displacement)



## Ship: KAIREI

Description: Japanese Deep Sea Oceanographic Research Vessel

Owner: Japan, Operated by Japan's Ministry of Education and Science

Features: Support

Primary Assignment: Support at the initial salvage site with ROV KAIKO conducting bottom search grid survey following the lift of EHIME MARU from 2000 feet of water.

Length: 346 feet

Beam: 52.8 feet

Draft: 15 feet

Displacement: 4,628 gross tons



## Ship: USCGC KITTIWAKE (WPB 87316)

Description: Coastal Patrol Boat

Owner: U.S. Coast Guard (Homeport Nawiliwili, HI)

Features: Sea keeping abilities up to sea state 5, integrated bridge system, ECDIS, surface search radar, Standard workstation III computers, fiber optic network, twin diesel engines

Primary Assignment: Search and Rescue

Length: 87 feet

Beam: 19.5 feet

Draft: 5 feet





## Ship: USS LAKE ERIE (CG 70)

Description: Guided Missile Cruiser

Owner: USN

Features: USS LAKE ERIE is a Guided Missile Cruiser, it was directed to the accident area from Pearl Harbor and used as a search and rescue vessel immediately following the accident.

Primary Assignment: SAR

Length: 567 feet

Beam: 55 feet

Draft: 23 feet

Displacement: 6,980 tons



## Ship: OCEAN HERCULES

Description: Cable Installation and Maintenance Vessel

Owner: SMIT – Oceaneering Cable Systems

Features: Grapnel winch, tugger winch, precise navigation system

Primary Assignment: Phase 0, Used ROV PHOENIX III to clear deck of cargo nets and other obstacles. Removed EHIME MARU mast with shape charge.

Length: 293 feet

Beam: 59.4 feet

Draft: 14.2

Displacement: 3,390 Gross Tons



## Ship: ROCKWATER 2

Description: Multi-purpose Monohull Diving Support Vessel

Owner: Breswater Offshore Contracting (registered owner), Haliburton Subsea provided the platform

Features: 150t/250t crane, 100t crane, 4-point mooring system serviced by winches, 18-man saturation diving spread, 16-man hyperbaric lifeboat, dynamic positioning with thrusters. Supported 3 ea ROVs (2 working, 1 observing), helipad

Primary Assignment: Primary salvage platform to lift and transport EHIME MARU from the initial salvage site to shallow water site.

Length: 391 feet

Beam: 72.6 feet

Draft: 25 feet

Displacement: 8,136 tons



## Ship: USS SALVOR (ARS 52)

Description: Auxiliary Rescue Ship constructed for naval rescue operations

Owner: USN

Features: Controllable Reversible Pitch propeller, Bow Thruster, Dive Platform for surface supply diving, complete with diving stage, Recompression chamber Cutting and welding equip, designed for open ocean towing, dynamic life possible over main bow or stern rollers, ROV platform

Primary Assignment: Phase 0-7. Primary platform for operating SWISS Side Scan Sonar and Deep Drone ROV.

Length: 255 feet

Beam: 51 feet

Draft: 16.7 feet

Displacement: 3,282 tons



## Ship: USNS SUMNER (T-AGS 61)

Description: Oceanographic Survey Ship

Owner: U.S. Navy, Military Sealift Command, Far East

Features: Trackline maneuvering, station keeping, data processing, multi-beam sonar, tethered and autonomous vehicle support, shipboard oceanographic data processing and sample analysis, deep ocean and coastal survey capabilities.

Primary Assignment: Conducted the initial hydrographic survey of bottom at wreck site. Surveyed the transit route from the Deep Water Recovery Site (DWRS) to the Shallow Water Recovery Site (SWRS). Lead escort ship from DWRS to SWRS, providing real-time depth, current, wind and wave data along the route.

Length: 328.5 feet

Beam: 58 feet

Draft: 19 feet

Displacement: 4,762 long tons





EQUIPMENT TRANSPORTED ON CMS 250 BARGE

## Barge: Crowley Marine Services Barge CMC 250

Description: Work Barge outfitted to work offshore in support of multiple projects

Owner: Crowley Marine Services

Features: Designed to transport cargo, equipment modules of all shapes and sizes

Primary Assignment: Moving cargo to and from worksite. Transported cargo to and from Honolulu during the mobilization and demobilization phases of the project.

Towed by MV SEA CLOUD

Length: 250 feet

Beam: 76 feet

Gross Tonnage: 5,970 DWT



## **Barge: Crowley Marine Services Barge CMC 450-10**

Description: Accommodation I Work Barge outfitted to work offshore in support of many different types of work.

Owner: Crowley Marine Services

Features: Helicopter pad, crane, ballast system, berthing and messing facilities, clear work deck for diving systems.

Primary Assignment: Support platform for the diving phase of the operation providing berthing, messing and working deck. During the final phase of the operation she was used to lift EHIME MARU at the SWRS and transport her to the final resting place in approximately 8,000 feet of water. Towed by MV SEA VALOR.

Length: 400 feet

Beam: 100 feet Displacement: 17.6 feet Gross Tonnage: 8099 tons

Open Deck: 5,000 sq ft





## ROV: DEEP DRONE

Description: 8,000-foot depth rated Remotely Operated Vehicle designed to meet the Navy's needs for deep ocean recovery.

Owner/Operator: USN SUPSALV/Phoenix Marine

Features: Electric propulsion, low noise signature, target locating sonar, two manipulators, 35mm still camera, black and white color TV camera, skid-mounted tool packages, 10,000-foot cable

Primary Assignment: Phase 0 surveying the bottom for debris and personal effects and performing a detailed survey of the hull damage on EHIME MARU.

Length: 9.3 feet

Width: 4.6 feet

Height: 6.2 feet

Max Depth: 8,000 feet

Payload: 300 lbs

Speed: 3 kts



## ROV: KAIKO

Description: Japanese ROV with max depth capability of 36,000 feet.

Owner/Operator: Japan Marine Science and Technology Center (JAMSTEC)

Features: CTD, Side-Scan sonar, Sub-bottom profiler, b and w camera, Panorama TV camera, 35mm still camera, manipulators, 39,000 ft cable.

Primary Assignment: Kaiko was operated from the Japanese Oceanographic vessel KAIREI after EHIME MARU had been relocated to complete a detailed survey of the sea floor at the initial salvage site.

### Launcher

Length: 17.6 feet  
Beam: 8.6 feet  
Height: 10.5 feet  
Weight in Air:  
Max Depth:  
Payload:

### Vehicle

10.2 feet  
6.6 feet  
7.6 feet  
5.3 tons  
36,000 feet  
330 lbs



## ROV: MANTA

Description: Remote Operated Vehicle

Owner: Canyon Offshore

Features: Used for observation (video) inspection and light construction

Primary Assignment: Rigging

### Launching Handling System

Length: 14 feet

Height: 17 feet

Width: 8 feet

Max Depth: 3,600 feet

Weight in Air: 23,400 lb

Payload: 100 lb

### Tether Management System

4.5 feet

5 feet

1,200 lb



## ROV: PHOENIX III

Description: Remotely Operated Vehicle (Phoenix class cable maintenance system)

Operator: SMIT Oceanering Cable Systems LLC., Manufacturer, Oceanering International, Inc.

Features: 3 video cameras, lights, depth and heading sensors, manipulators and cutters, high pressure nozzles, 8 hydraulic thrusters for propulsion 2 axial, 4 vertical, 2 lateral

Primary Assignment: Phase I, cut off mast using a shaped charge at the DWRS. Cleared deck of debris in preparation for lifting EHIME MARU. Operated off OCEAN HERCULES.

Depth rating: 9,800 feet

Payload: 500 lbs

Forward speed: 2.5 kts



## ROV: QUEST

Description: New generation, environmentally friendly, electric Quest work class ROV

Owner: Canyon Offshore

Features: 110 hp, 7 X 7.5 kw thrusters (4 horiz, 3 vertical)

Primary Assignment: Rigging of EHIME MARU at 2,000'

Max Depth: 10,000 feet

Payload: 352 lb



## ROV: SCORPIO II

Description: Remotely Operated Vehicle (sometimes referred to as Super Scorpio)

Owner/Operator: USN, SUBDEVRON 5, Deep Submergence Unit

Features: 4 thrusters, seven function manipulator arm, 350 lb lift capability at full extension, b & w and color video-camera with full pan and tilt, surveying capabilities, sonar (range 2,000 ft)

Primary Assignment: Locate and survey the hull of EHIME MARU.

Length: 8 feet

Width: 4 feet

Height: 4 feet

Max Depth: 3,000 ft

Payload: 242 lb

Speed: 4 kts fore/aft, 3 kts right/left



## ROV: XL-16

Description: Work Class Remotely Operated Vehicle (Triton)

Owner: Canyon Offshore

Features: High performance with dependability at depth, seven thrusters in quad format

Primary Assignment: Rigging of EHIME MARU at 2,000 feet.

Max Depth: 6,560-8,200 feet

Power: 100 hp

Payload: 661 lb



## *Appendix C*

# Selected Press Releases

### Table of Contents

SCORPIO II Finds EHIME MARU .....	C-3
Salvage Decision to be Based on Technical Feasibility .....	C-4
Japanese Salvage Experts View U.S. Navy Survey Operations .....	C-5
EHIME MARU Salvage Feasibility Study Update.....	C-6
Environmental Assessment Progressing.....	C-7
Environmental Assessment Update .....	C-8
Environmental Assessment Update .....	C-10
Navy Officials Tour EHIME MARU Sister Ship .....	C-11
OCEAN HERCULES to Arrive .....	C-12
Mast Removal Begins Today .....	C-13
Recovery Operation Press Conference.....	C-15
Japanese Experts to Assist in EHIME MARU Recovery .....	C-17
Opportunity to Observe Diver Training .....	C-18
JMSDF Submarine Rescue Ship Arrives Monday.....	C-19
Barge to Support Recovery Operation Arrives.....	C-20
Recovery Operation Update.....	C-21
Pre-diving Training Aboard JDS CHIHAYA.....	C-22
Diver Training Photo Opportunity .....	C-23
Stern Lift of EHIME MARU Successful.....	C-24
Rigging Adjustment .....	C-25
Tour JDS CHIHAYA and View Ship's Diving Gear .....	C-27
Stern Lift Update.....	C-28
Safety Zone Reminder.....	C-29
ROCKWATER 2 Returns to Load Stern Lift Strap.....	C-30
ROCKWATER 2 Returns to Port .....	C-31
Japan's Minister for Foreign Affairs to Visit EHIME MARU Recovery Effort .....	C-32
Updated Cost Estimate .....	C-33
Anchors in Storage on Vessel's Deck.....	C-34
Alternate Bow Rigging.....	C-35
ROCKWATER 2 Returns to Load Lifting Frame Assembly .....	C-36
CHIHAYA's Mission in Recovery Operation Expanded .....	C-37
Initial Lift Begins.....	C-38
ROCKWATER 2 to Return to Re-rig Lift Assembly.....	C-39
ROCKWATER 2 returns to Reconfigure Lifting Frame Assembly .....	C-40

**F/V EHIME MARU Recovery and Relocation Report**

ROCKWATER 2 Lifts EHIME MARU ..... C-41

ROCKWATER 2 Sets EHIME MARU Down at Shallow Water Recovery Site ..... C-42

Navy Divers Enter Water, Begin Initial Survey of EHIME MARU’s Exterior ..... C-43

Divers Found and Recovered Remains ..... C-44

Divers Locate and Recover Additional Remains ..... C-45

Divers Locate Fourth Remains, Recover Third ..... C-46

Divers Bring Third, Fourth Sets of Remains to Surface ..... C-47

Divers Locate, Recover Fifth Remains ..... C-48

Divers Locate, Recover Sixth Set of Remains ..... C-49

Media Photo Opportunity: Families Review Recovery Operations ..... C-50

Divers Locate, Recover Seventh Set of Remains ..... C-51

Divers Locate, Recover Eighth Set of Remains ..... C-52

Divers Pause to Repair Spreader Assembly ..... C-53

Divers Repair Spreader Assembly ..... C-54

Navy Begins Final EHIME MARU Relocation ..... C-55

Navy Begins Final EHIME MARU Relocation ..... C-56

ROCKWATER 2 Fact Sheet ..... C-59

JDS CHIHAYA Fact Sheet ..... C-61

Crowley Barge (CMC) 450-10 Fact Sheet ..... C-62

Admiral Thomas B. Fargo, becomes 29th U.S. Pacific Fleet Commander ..... C-64

# SCORPIO II Finds EHIME MARU

## U.S. Pacific Fleet Public Affairs

---

PEARL HARBOR (Feb 17, 2001) -- The Navy found Ehime Maru at 11:29 p.m. Friday, Feb. 16 sitting nearly upright in 2,003 feet of water. This was approximately 1,000 yards from the collision site reported by USS Greeneville (SSN 772).

The remotely operated vehicle Scorpio II detected Ehime Maru with its onboard sonar at 11:25 p.m. Then positive identification was confirmed at 11:29 p.m. by reading the stern plate of the vessel as seen through Scorpio II's video cameras.

The Navy is continuing its search operation with Scorpio II to gather additional data on the ship.

Ehime Maru was located at latitude 21-04.95 N, longitude 157-49.58 W.

# Salvage Decision to be Based on Technical Feasibility

## U.S. Pacific Fleet Public Affairs

---

PEARL HARBOR (Feb 19, 2001) -- The Government of Japan has requested the Ehime Maru be salvaged. The U.S. Government will make a decision on the salvage of the Ehime Maru based solely on technical feasibility.

A survey of the vessel is currently being conducted to collect data to determine the technical feasibility of salvaging it. This survey commenced Feb. 16 and is expected to take several days. The analysis of the survey data and the development of salvage options available, if any, are expected to take several weeks.

These time frames are approximate and are subject to change.

# Japanese Salvage Experts View U.S. Navy Survey Operations

## U.S. Pacific Fleet Public Affairs

---

PEARL HARBOR (Feb 26, 2001) -- Five Japanese salvage experts and a representative from the Japanese Consulate here visited USS Salvor (ARS 52) today to see Navy survey operations by the remotely operated vehicle (ROV) Deep Drone. The team left Pearl Harbor this morning aboard a Navy boat, which took them to Salvor's location about nine miles south of Waikiki where Ehime Maru sank Feb. 9.

During the day-long visit, the group also saw the side-scan sonar called Shallow Water Intermediate Search System or SWISS aboard Salvor. Deep Drone and SWISS cannot operate simultaneously from the same support vessel.

The group consisted of Hiroshi Sato, chief of the oceanography office of Japan's Ministry of Foreign Affairs; Keiichi Yokota of the office of the secretary of the cabinet; Hiroyasu Monma of the Ocean Science and Technology Center's research department; Hiroyasu Takemoto of the Ministry of Transportation's Laboratory of Shipping Technology; Haruo Kawakami of Fukada Salvage Co. Ltd. and Kouichi Shiota of the consulate's office in Honolulu.

The undersea surveys began Feb. 16 with SWISS, Deep Drone and another Navy ROV Scorpio II, which operated from the Motor Vessel C-Commando.

U.S. Navy and Japanese salvage experts will examine the data collected by the side-scan sonar survey and video from the two ROVs and make a recommendation on whether salvaging Ehime Maru from a depth of 2,000 feet is feasible. The experts are also examining other items, such as drawings of the ship.

These experts will not make the final decision on whether to salvage the ship, but will instead make recommendations to the U.S. government, which will then decide based solely on technical feasibility.

The Japanese salvage experts arrived in Honolulu Feb. 21 and immediately started a series of meetings with U.S. Navy officials. At the outset, Japan and the United States had agreed that salvage experts from both sides would cooperate and consult closely when studying the feasibility of a salvage operation.

# EHIME MARU Salvage Feasibility Study Update

## Pacific Fleet Public Affairs

---

PEARL HARBOR (Mar 12, 2001) -- The U.S. Navy has received the first portion of a feasibility study for salvage of the Japanese motor vessel Ehime Maru.

Salvage of a vessel of this size from a depth of 2,000 feet is a complex and precedent-setting operation. The engineering portion of the study has identified a potentially feasible salvage option. However, the option requires a two-phase lift that would bring the vessel into shallow water and therefore requires an environmental review with federal and state officials.

Detailed planning and resolution of environmental and other technical issues still remain. Initial analysis indicates the salvage would take approximately six months to complete, at an estimated cost of \$40 million. It should be emphasized that the initial estimate could be revised as detailed planning and analysis continue.

The U.S. Navy will work with federal agencies, state of Hawaii officials, and the U.S. Coast Guard in order to complete a comprehensive environmental assessment.

The Government of Japan will be consulted and kept abreast of developments as the analysis and assessment progress.

For more information, contact the Pacific Fleet Public Affairs Office at (808) 471-3769.

# Environmental Assessment Progressing

## U.S. Pacific Fleet Public Affairs

---

PEARL HARBOR (Apr 5, 2001) -- An environmental assessment is underway to determine whether the operation to recover crewmembers from the Ehime Maru will have any significant impact on the environment.

The contractor preparing the assessment is EDAW Inc., of Huntsville, Ala. It has extensive experience with environmental issues in Hawaii, including preparing environmental assessments for the Pacific Missile Range Facility on Kauai and the RIMPAC exercises that are held in Hawaiian waters every two years.

As part of the on-going effort, which began in mid-March, Navy officials again met with state and federal officials today to discuss the potential impacts of lifting a ship weighing more than 750 metric tons from a depth greater than 2,000 feet -- an unprecedented operation.

The assessment is expected to take several months. The Navy will move expeditiously in this process, but also wants to ensure it is done comprehensively and correctly.

The state agencies the Navy has been working with include the Department of Land and Natural Resources and Department of Health. The federal agencies include the Environmental Protection Agency, "NOAA Fisheries" -- part of the National Oceanic and Atmospheric Administration, the U.S. Coast Guard, and the U.S. Fish and Wildlife Service -- part of the U.S. Department of Interior.



# Environmental Assessment Update

## U.S. Pacific Fleet Public Affairs

---

PEARL HARBOR (May 4, 2001) -- The Navy continues its preparation of an environmental assessment to determine whether moving Ehime Maru from its current location, about nine miles south of Diamond Head, will have an impact on the environment.

Today, the Navy provided the federal and state agencies portions of the draft assessment for review. Additional portions will be provided later this month as they are completed.

Since mid-March, the Navy has been working with several state of Hawaii and federal agencies on the environmental assessment, which is examining potential impacts moving the vessel may have on water quality, fish, coral, turtles and marine mammals.

The state agencies include the Governor's office, State Department of Land and Natural Resources, State Department of Health, Attorney General's office, State Department of Transportation and State Department of Business, Economic Development and Tourism.

The federal agencies include the National Marine Fisheries Services or "NOAA Fisheries" -- part of the National Oceanic and Atmospheric Administration, the U.S. Fish and Wildlife Service (part of the U.S. Department of Interior), Environmental Protection Agency, Federal Aviation Administration and U.S. Coast Guard.

The assessment includes examining potential sites to which the ship can be moved, a requirement set by the National Environmental Policy Act. The best site would have a flat, sandy bottom, be about 100-feet deep and have minimal tidal flow. Due to the complexity of the proposed plan, the Navy also wants to minimize the distance to the recovery site.

The Navy hopes to complete the assessment by mid-June in order to conduct the recovery operation in late summer. This period will take advantage of the best sea state and wind conditions to maximize environmental protection. While the Navy wants to move expeditiously, it also wants to ensure the assessment is done comprehensively and correctly.

A company contracted by the Navy recommended lifting the 750-metric ton ship from where it lies at 2,000 feet and moving it while still submerged to a depth at which divers can reach it. The divers would then search the ship to recover the missing crewmembers and personal effects -- a task that cannot now be accomplished due to the greater depth.

Even if environmentally feasible, the operation will be highly complex and pose a number of challenges. An object the size of Ehime Maru has never been raised from 2,000 feet. It is possible the vessel could suffer additional structural failure during the movement due to the existing damage to its hull and the stresses imposed by lifting and transport. Depending on the extent of any additional structural failure, the operation may be halted.

Once in place at the shallower site, divers will have to navigate tight and damaged compartments. Not every space may be physically accessible and some spaces may not be safe for divers to enter. Safety will be paramount throughout the recovery operation.

# Environmental Assessment Update

## U.S. Pacific Fleet Public Affairs

---

PEARL HARBOR (May 11, 2001) -- The Navy met yesterday with federal and state agencies to review the environmental assessment it is preparing to determine whether moving Ehime Maru will have a significant impact on the environment.

The initial chapters of the draft assessment were delivered to the agencies last week and on Wednesday the Navy provided the remaining portions.

Support among the various agencies during the assessment has been strong. With this cooperation, the proposal to lift Ehime Maru from where it lies at 2,000 feet and moving it while still submerged to shallower water incorporates many measures to protect the environment.

For example, if the assessment determines there would be no significant impact on the environment and the Navy is able to proceed with its plan, the following actions are among those being proposed as part of the operation:

- Bird habitats would be inventoried before and after the operation;
- U.S. Fish & Wildlife Service personnel would be aboard oil skimmers to care for any birds that come in contact with the oil;
- Cargo nets, long-line fishing gear and other equipment that may become a hazard to reefs, turtles or other ocean life would be removed from the vessel;
- The ship's present location and the shallow-water site would be surveyed to ensure no material is left behind; and
- An extensive analysis of sea state and wind direction and speed, as well as real-time spot weather forecasts, would allow the Navy to choose an optimal time for the vessel's movement to the shallow-water site.

The Navy will continue to work with the federal and state agencies on the environmental assessment, which is expected to be complete in mid-June.

# Navy Officials Tour EHIME MARU Sister Ship

CPF HOME EHIME MARU RECOVERY NEWS

## U.S. Pacific Fleet Public Affairs

---

PEARL HARBOR (Jun 29, 2001) -- Navy officials, including divers expecting to participate in the Ehime Maru recovery operation, will tour Kagawa Maru, a similar ship that will be visiting Honolulu. Safety is paramount in the recovery operation, scheduled for later this summer. The two days of tours for about 40 divers and technical experts will increase the divers' familiarity with Ehime Maru's interior and maximize the operation's success.

When the Navy learned Kagawa Maru would be visiting Honolulu Harbor, it asked Japanese officials for, and received, permission to tour the ship in port.

Rear Adm. William Klemm, who is leading the recovery operation, will be available to talk to media about the tours at 11:30 a.m. Sunday at Honolulu Harbor Pier 9 at Aloha Tower Marketplace. Media are invited to be in place at 11:15 a.m. to capture b-roll of Navy personnel departing the ship.

Media are asked to limit coverage of the tours to 11:15 a.m. Sunday because Navy officials touring Kagawa Maru will not be available for interviews at other times. This is an official U.S. Navy web site.

Please read this privacy and security notice before entering this site.

Designed and maintained by the Pacific Fleet Public Affairs Office.

Send recommendations and comments to the Fleet Webmaster.

If commenting about a specific page, please include the page title in your correspondence.

Revised 6/29/01 at 1:46 p.m. (HST)

## OCEAN HERCULES to Arrive

CPF HOME EHIME MARU RECOVERY NEWS

### U.S. Pacific Fleet Public Affairs

---

PEARL HARBOR (Jul 12, 2001) -- Ocean Hercules, the vessel contracted by the Navy to prepare Ehime Maru for this summer's recovery operation, is scheduled to arrive in Honolulu Harbor about 7 a.m. tomorrow.

The approximately 266-foot-long vessel, which left San Francisco July 5, will be at Honolulu Harbor's Pier 1 for 24 to 48 hours. It will then head to the spot about 9 miles south of Oahu where Ehime Maru now lies in 2,000-feet of water. Once there, it will prepare the ship for the arrival in early August of Rockwater 2, which will try to lift Ehime Maru about 100 feet off the ocean floor and move it while still submerged to shallower water about a mile south of Honolulu International Airport's Reef Runway. When it is stabilized at a depth of about 115 feet, divers will search all safely accessible areas to recover missing crewmembers, personal effects and certain unique characteristics of the ship, such as its nameplate and anchors, for a possible memorial.

Ocean Hercules' prep work will include using the remotely operated vehicle (ROV) Phoenix to attempt to clear Ehime Maru's decks to the extent possible of any cargo nets and other obstacles that might impact the marine environment.

Honolulu Harbor's Pier 1 is not publicly accessible.

This is an official U.S. Navy web site.

Please read this privacy and security notice before entering this site.

Designed and maintained by the Pacific Fleet Public Affairs Office.

Send recommendations and comments to the Fleet Webmaster.

If commenting about a specific page, please include the page title in your correspondence.

Revised 7/26/01 at 1:46 p.m. (HST)

## Mast Removal Begins Today

CPF HOME EHIME MARU RECOVERY NEWS

### U.S. Pacific Fleet Public Affairs

---

PEARL HARBOR (Jul 20, 2001) -- Ocean Hercules, the vessel contracted by the Navy to prepare Ehime Maru for this summer's recovery operation, has begun the process to remove the ship's center mast.

The center mast must be removed because it would obstruct the spreader assembly or lower frame that will be placed immediately above Ehime Maru.

Ocean Hercules' crew, using the remotely operated vehicle (ROV) Phoenix III, will cut the mast off using a shaped charge -- about 1.5 pounds of C-4 explosive placed at the base of the mast in a U-shaped linear charge that directs the explosive energy inward toward the mast. The small charge was considered the safest and most controllable method to remove the mast. It is a technology that has been well researched and routinely used in the offshore oil industry for many years.

An ROV will connect a lifting wire to the mast so a crane or winch can lift it from the sea floor to the ocean surface and then onto the deck of the ship. Mast recovery may occur with Ocean Hercules or Rockwater 2 early next month. The decision will be based on the on-going work schedule of Ocean Hercules.

The mast removal is part of the on-going preparation on Ehime Maru before the arrival of Rockwater 2, which will try to lift the ship about 100 feet off the ocean floor and move it while still submerged to shallower water about a mile south of Honolulu International Airport's Reef Runway. When it is stabilized at a depth of about 115 feet, divers will search all safely accessible areas to recover missing crewmembers, personal effects and certain unique characteristics of the ship, such as its nameplate and anchor, for a possible memorial. Hazardous materials such as fuel oil and freon cylinders will also be removed to the maximum extent practicable.

Ocean Hercules' prep work also includes using Phoenix III to attempt to clear or secure Ehime Maru's decks of any fishing long lines and other obstacles that might impact the marine environment. It will also clear away the ocean floor adjacent to the Ehime Maru where the lifting plates will be pulled under the ship. This clearing operation will provide a better angle of approach for pulling the two lifting plates under the vessel's hull.

## **F/V EHIME MARU Recovery and Relocation Report**

There is the potential, however unlikely, that some diesel fuel -- a light, refined petroleum product that quickly evaporates within hours or days -- may be released during the mast-removal operation. Because of that, the Navy will deploy a skimmer with two 300-foot containment booms and two towboats. There will also be two helicopters overhead to inspect the area and direct the skimmer to the location of any potential diesel fuel release.

This is an official U.S. Navy web site.

Please read this privacy and security notice before entering this site.

Designed and maintained by the Pacific Fleet Public Affairs Office.

Send recommendations and comments to the Fleet Webmaster.

If commenting about a specific page, please include the page title in your correspondence.

Revised 7/26/01 at 1:46 p.m. (HST)



# Recovery Operation Press Conference

CPF HOME EHIME MARU RECOVERY NEWS

## U.S. Pacific Fleet Public Affairs

---

PEARL HARBOR (Jul 26, 2001) -- media an operational overview at 1 p.m. Aug. 2. Representatives from the Japan Maritime Self Defense Force and U.S. Navy technology experts will also be present.

Additionally, technical experts from Japan have been invited to participate.

The brief will be followed by a tour of Rockwater 2, the vessel that will lift Ehime Maru from its current, 2,000-foot depth, and transport it while suspended beneath the ship to an area about 1 mile south of Honolulu International Airport's Reef Runway. The tour will be led by Capt. Bert Marsh, director of ocean engineering and supervisor of salvage and diving at the Naval Sea Systems Command in Crystal City, VA.

Space in the briefing room and on the tour is limited, so interested media must contact the Pacific Fleet Public Affairs Office at (808) 471-3769 no later than 4 p.m., July 31.

Media will park at Honolulu Harbor Pier 1, accessible via Forrest Avenue off Ala Moana, and be bused to the briefing room about a half-mile away. Following the brief, media will be bused back to Pier 1 for the Rockwater 2 tour.

In addition, at 9 a.m. Aug. 3, there will be a visit to the media center that will be used once Ehime Maru has reached the shallow water site. This visit is not for reporting purposes, but is to allow media a chance to see the center location before the operation begins.

Here's a rundown of the schedule:

July 31 (Tuesday)

4 p.m. -- Deadline to register for brief and tour.

Aug. 1 (Wednesday)

About 8 a.m. -- Rockwater 2 arrives Honolulu Harbor.

Aug. 2 (Thursday)

12:30 p.m. -- Bus leaves Pier 1 for briefing room

1 p.m. -- Recovery Operation Brief begins

## **F/V EHIME MARU Recovery and Relocation Report**

~ 2:30 p.m. -- Rockwater 2 tour begins

Aug. 3 (Friday)

9 a.m. -- Meet at Pearl Harbor PSD to board bus for media center site visit. (Not for reporting purposes.)

This is an official U.S. Navy web site.

Please read this privacy and security notice before entering this site.

Designed and maintained by the Pacific Fleet Public Affairs Office.

Send recommendations and comments to the Fleet Webmaster.

If commenting about a specific page, please include the page title in your correspondence.

Revised 7/26/01 at 1:46 p.m. (HST)

# Japanese Experts to Assist in EHIME MARU Recovery

CPF HOME EHIME MARU RECOVERY NEWS

## U.S. Pacific Fleet Public Affairs

---

PEARL HARBOR (Aug 1, 2001) -- Two structural technical experts are scheduled to arrive from Tokyo Aug. 2 to assist the U.S. Navy in the Ehime Maru recovery operation. This represents the latest example of the continued cooperation between Japan and the United States during the operation.

One expert, Dr. Isshin Fujii, is from the same company that built Ehime Maru. He is manager of the Hull Structure Planning Section, Ship Design Department of Shin Kurushima Dockyard Company, Ltd.

Hiroyasu Takemoto is from the Structural Mechanics Division of the Japanese government's National Maritime Research Institute.

These technical experts will serve as advisors to help ensure both nations are united in decisions affecting the recovery operation, particularly technical feasibility and diver safety.

Although the Navy is confident it will be able to successfully conduct the operation, the recovery is not without risks and there is no guarantee of success. The structural damage to Ehime Maru may be greater than anticipated and thus pose a safety risk to recovery personnel or prevent the vessel to be moved intact.

Japan Maritime Self Defense Force divers will also observe and participate in the operation.

This is an official U.S. Navy web site.

Please read this privacy and security notice before entering this site.

Designed and maintained by the Pacific Fleet Public Affairs Office.

Send recommendations and comments to the Fleet Webmaster.

If commenting about a specific page, please include the page title in your correspondence.

Revised 8/1/01 at 5:46 p.m. (HST)

## Opportunity to Observe Diver Training

CPF HOME EHIME MARU RECOVERY NEWS

### U.S. Pacific Fleet Public Affairs

---

PEARL HARBOR, HAWAII (Aug 13, 2001) -- Media are invited to film and observe U. S. Navy and Japanese divers involved in the Ehime Maru recovery operation as they train pierside Wednesday, Aug. 15. The divers will set up on the pier the same way they will set up on the diving platform they will use once they begin operations with Ehime Maru at the shallow water recovery site.

Media will also get a briefing on background from the divers.

U.S. Navy divers and Japanese divers from the U.S. Navy Ship Repair Facility (SRF), Yokosuka, Japan, will begin recovery operations on Ehime Maru after the ship is moved to the shallow water recovery site. Japan Maritime Self-Defense Force divers will also participate in the operation.

Media need to meet at the Pearl Harbor PSD at 9:30 a.m. Wednesday to be bused to the Mobile Diving and Salvage Unit One (MDSU-1) facility. Media should park in the gravel lot above the paved parking lot at PSD. Media will not be allowed to drive to the facility.

Revised 8/13/01 at 1:20 p.m. (HST)

# JMSDF Submarine Rescue Ship Arrives Monday

CPF HOME EHIME MARU RECOVERY NEWS

## U.S. Pacific Fleet Public Affairs

---

PEARL HARBOR, Hawaii (Aug 17 2001) -- The Japanese Defense Ship (JDS) Chihaya will arrive at the Pearl Harbor Naval Station approximately 3:30 p.m., Monday, Aug. 20.

Capt. Masao Kuramoto commands Chihaya, a submarine rescue ship in the Japan Maritime Self-Defense Force. He and his crew of 130 sailors are participating in the Ehime Maru recovery operation.

Media interested in covering Chihaya's arrival should contact the Pacific Fleet Public Affairs Office at (808)284-2938 no later than 4 p.m., Sunday, Aug. 19.

Media need to meet at Pearl Harbor's Personnel Support Detachment (PSD) at 2:15 p.m. to be bussed to the pier. Media will not be allowed to drive to the pier.

Rundown of Schedule:

Aug. 19 (Sunday)

4 p.m. Deadline to register for arrival of Chihaya

Aug. 20 (Monday)

2:15 p.m. Press arrive Personnel Support Detachment (PSD) to be escorted to arrival pier

3:30 p.m. JDS Chihaya arrives Pearl Harbor

3:50 p.m. Press Availability with Chihaya Commanding Officer

Revised 8/17/01 at 12:50 p.m. (HST)

## Barge to Support Recovery Operation Arrives

CPF HOME EHIME MARU RECOVERY NEWS

### U.S. Pacific Fleet Public Affairs

---

PEARL HARBOR, Hawaii (Aug 20 2001) -- A barge contracted by the Navy to support the shallow water recovery operation of Ehime Maru arrived today (Monday) at Pearl Harbor Naval Station.

The roughly 400-foot-long Crowley Maritime Corp. 450-10 barge, which left Long Beach, Calif., Aug. 7, will be at Pearl Harbor to onload equipment and allow divers from Mobile Diving and Salvage Unit One the opportunity to conduct training dives.

The barge will serve as a work platform and accommodations barge for Navy divers after Ehime Maru is moved from the its present location to the shallow water recovery site less than a mile south of Honolulu International Airport's Reef Runway. When Ehime Maru is stabilized at a depth of about 115 feet, the divers will search all safely accessible areas to recover missing crewmembers, personal effects and certain unique items from the ship, such as its nameplate and anchor, for a possible memorial.

Media will be invited to photograph the barge while it is berthed at the Navy pier at a date and time to be determined. Navy Public Affairs will announce the date and time once it is scheduled.

Revised 8/20/01 at 12:50 p.m. (HST)

# Recovery Operation Update

CPF HOME EHIME MARU RECOVERY NEWS

## U.S. Pacific Fleet Public Affairs

---

PEARL HARBOR, Hawaii (Aug 22 2001) -- Capt. Bert Marsh, supervisor of salvage for the U.S. Navy, will provide an update on the Ehime Maru recovery operation at 1 p.m. on Wednesday Aug. 22 at the Ehime Maru Media Center, located at the Navy Diving complex pier.

Media need to meet at noon today at the Pearl Harbor Personnel Support Detachment (PSD) to be bused to the Media Center. Media are reminded to park in the dirt lot above the paved PSD parking lot. The center will be used for today's briefing only and will not open until the day before the lift phase begins, as previously scheduled.

The media availability with USS Salvor and the Deep Drone demonstration scheduled for 2 p.m. today has been postponed. CPF Public Affairs will announce when it is rescheduled.

Revised 8/22/01 at 8:33 a.m. (HST)



# Pre-diving Training Aboard JDS CHIHAYA

CPF HOME EHIME MARU RECOVERY NEWS

## U.S. Pacific Fleet Public Affairs

---

PEARL HARBOR, Hawaii (Aug 24, 2001) -- The Japan Maritime Self Defense Force Submarine Rescue Ship JDS Chihaya will commence diver training in the vicinity of the Shallow Water Recovery Site (SWRS) off of the Honolulu International Airport's Reef Runway, Monday, Aug. 27.

The objective of this training is to familiarize the JMSDF divers with local Hawaiian diving conditions that are expected to be encountered at the Ehime Maru shallow water site, such as current, water temperature, bottom conditions and underwater visibility. Additional testing of JDS Chihaya's Remotely Operated Vehicle will also be conducted.

JDS Chihaya's Commanding Officer, Capt. Kuramoto, has underscored the importance of safety for the JMSDF role in Ehime Maru recovery operations. This training will ensure safety remains the highest priority during this operation.

Revised 8/24/01 at 11:03 a.m. (HST)

# Diver Training Photo Opportunity

CPF HOME EHIME MARU RECOVERY NEWS

## U.S. Pacific Fleet Public Affairs

---

PEARL HARBOR, Hawaii (Aug 29, 2001) -- Media are invited to photograph U.S. Navy divers involved in the Ehime Maru recovery operation as they train pier side on Friday, Aug. 31.

Divers will be training from the Crowley 450-10 barge. The barge will serve as a work platform and accommodations barge for divers after Ehime Maru is moved from its present location to the shallow water recovery site. The barge will also be used to transport Ehime Maru from the shallow water recovery site to the deep-water relocation site at the conclusion of the operation.

Media need to meet at the Pearl Harbor Personnel Support Detachment at 9:30 a.m. to be bused to the Crowley 450-10 barge located at the Navy diving complex on Navy Region Hawaii. Media should park in the gravel lot above the paved parking lot at PSD. Please RSVP by 4 p.m. on Thursday, Aug. 30 if interested in attending. Media will not be allowed to drive to the facility.

For more information, call (808) 471-3769, 474-4178, 286-0585.

Revised 8/29/01 at 10:45 a.m. (HST)

## **Stern Lift of EHIME MARU Successful**

**CPF HOME EHIME MARU RECOVERY NEWS**

### **U.S. Pacific Fleet Public Affairs**

---

PEARL HARBOR, Hawaii (Aug 30, 2001) -- Navy efforts to lift the stern of Ehime Maru were successful. Rockwater 2 used its main linear winches and a sling under Ehime Maru's stern to lift it off the bottom while cranes on Rockwater 2 pulled two 36mm messenger wires under the hull. Once the messenger wires were under the hull, the stern was lowered back to the bottom. The stern lift began shortly before 5:30 p.m. Aug. 29 and was completed by 1 a.m. the following day.

A Coast Guard helicopter sent to the site at first light reported a sheen estimated to be less than 1 gallon of diesel fuel southwest of Rockwater 2. A Navy skimmer system was dispatched, however diesel fuel is a light, refined petroleum product that evaporates within hours, lessening the chance that it would harm the environment.

There was no indication the stern lift caused any damage to Ehime Maru.

During the initial stages of the stern lift, the Navy had an open-ocean skimmer system on scene, and two helicopters patrolled for signs of any diesel fuel to direct the skimmers, if needed. There also were two Navy skimmers and a commercial skimmer system standing by. Additionally, the Navy has studied tides, currents and weather conditions in the area and monitors them constantly. Potential dispersal patterns from a fuel release have been modeled extensively by the Navy and the National Oceanic and Atmospheric Administration, and they predict that any fuel released would be carried out to sea.

The messenger wires will be used to pull lifting plates under Ehime Maru's hull. Media will be notified when that event and other significant events occur. After the plates are in place, Rockwater 2 will return to port to retrieve additional equipment needed to lift Ehime Maru for the transport to the shallow-water recovery site. The lift and transport is scheduled to occur in mid-September.

Please continue to check this site for additional updates.

Revised 8/30/01 at 12:35 p.m. (HST)

## Rigging Adjustment

CPF HOME EHIME MARU RECOVERY NEWS

### U.S. Pacific Fleet Public Affairs

---

PEARL HARBOR, Hawaii (Aug 30, 2001) -- After the Navy successfully lifted Ehime Maru and pulled two messenger wires under the ship, it discovered the forward messenger wire needed to be adjusted.

The wires, which will be used to pull two massive plates under the ship so it can be lifted off the ocean floor, must be placed precisely to ensure Ehime Maru can safely be lifted from its 2,000-foot location.

Rockwater 2 used its main linear winches and a sling under Ehime Maru's stern to lift it off the bottom while cranes on Rockwater 2 pulled the two 36mm messenger wires under the hull. Once the messenger wires were under the hull, the stern was lowered back to the bottom. The stern lift began shortly before 5:30 p.m. Aug. 29 and was completed by 1 a.m. the following day.

When the clouds of sediment had finally settled, a remotely operated vehicle discovered the forward wire was snagged around the middle of Ehime Maru. It needed to be under the ship's pilot house.

The second wire appears to be placed where it needed to be under the ship's engine room.

Rockwater 2 attempted to move the forward wire to its correct position without moving Ehime Maru but will have to lift the ship's stern again. That event is scheduled for late today or early tomorrow.

There was no indication the first stern lift caused any damage to Ehime Maru.

The Navy is prepared in case diesel fuel is released. In accordance with the environmental assessment prepared earlier this year, a number of measures to protect the environment were in place before the recovery operation began in June.

A Coast Guard helicopter sent to the site this afternoon reported a sheen estimated to be less than two gallons of diesel fuel southwest of Rockwater 2. A Navy skimmer system was on-scene this morning, however diesel fuel is a light, refined petroleum product that evaporates within hours or days, lessening the chance that it would harm the environment. It also is readily and completely degraded by naturally occurring microbes, according to information from the National Oceanic and Atmospheric Administration. Because diesel fuel is so light and because of its low viscosity, it spreads quickly to a thin film when on

## **F/V EHIME MARU Recovery and Relocation Report**

water – it will not sink and accumulate on the sea floor. An amount as small as a gallon can create a sheen as big as football field.

During the initial stages of the stern lift, the Navy had an open-ocean skimmer system on scene, and two helicopters patrolled for signs of any diesel fuel to direct the skimmers, if needed. There also were two Navy skimmers and a commercial skimmer system standing by. Additionally, the Navy has studied tides, currents and weather conditions in the area and monitors them constantly. Potential dispersal patterns from a fuel release have been modeled extensively by the Navy and the National Oceanic and Atmospheric Administration, and they predict that any fuel released would be carried out to sea.

Media will be notified when the lifting plates are pulled under Ehime Maru and other significant events occur. After the plates are in place, Rockwater 2 will return to port to retrieve additional equipment needed to lift Ehime Maru for the transport to the shallow-water recovery site. The lift and transport is scheduled to occur in mid-September.

A company contracted by the Navy recommended lifting the 750-metric ton Ehime Maru from where it lies about nine nautical miles south of Diamond Head and moving it while still submerged to a depth at which divers can reach it. The divers would then search the ship to recover the missing crewmembers and personal effects – a task that cannot now be accomplished due to the greater depth.

The operation is highly complex and poses a number of challenges. For example, an object the size of Ehime Maru has never been raised from 2,000 feet. And once in place at the shallower site, divers will have to navigate tight and damaged compartments. Not every space may be physically accessible and some spaces may not be safe for divers to enter. Safety is paramount throughout the recovery operation.

Please continue to check this site for additional updates.

Revised 8/30/01 at 5:35 p.m. (HST)

# Tour JDS CHIHAYA and View Ship's Diving Gear

CPF HOME EHIME MARU RECOVERY NEWS

## U.S. Pacific Fleet Public Affairs

---

PEARL HARBOR, Hawaii (Aug 31, 2001) -- Media are invited to tour the Japan Maritime Self-Defense Force Submarine Rescue Ship JDS Chihaya on Tuesday, Sept. 4, at 2 p.m. at the Pearl Harbor Naval Station.

Divers from Chihaya are preparing to participate in the recovery operation at the Shallow Water Recovery Site (SWRS) where they will assist U.S. Navy divers when Ehime Maru is transported there. Media will have an opportunity to view Chihaya's remotely operated vehicle (ROV), diving gear and chamber with explanation by divers from Chihaya.

Media need to meet at the Pearl Harbor Personnel Support Detachment at 1:30 p.m. to be bused to the piers where Chihaya is moored. Media should park in the gravel lot above the paved parking lot at PSD. Please RSVP by noon Monday, Sept. 3, to 286-0585 if interested in attending. Media will not be allowed to drive to the pier.

Revised 8/31/01 at 12:20 p.m. (HST)

## **Stern Lift Update**

**CPF HOME EHIME MARU RECOVERY NEWS**

### **U.S. Pacific Fleet Public Affairs**

---

PEARL HARBOR, Hawaii (Aug 31, 2001) -- The stern lift sling from Rockwater 2 broke today while attempting to adjust a snagged messenger wire.

The ship had used the sling to lift Ehime Maru's stern around 5:30 p.m. Aug. 31, but set it back down because of concerns about its placement under the stern. A second lift was attempted, but the sling apparently broke when the ship was about 24 feet above the ocean floor.

No details were immediately available because sediment prevented remotely operated vehicles from seeing the area. An assessment will be made once the sediment settles.

On Wednesday, the Navy successfully lifted Ehime Maru and pulled two messenger wires under the ship, but discovered the following day – after the water had cleared – that the forward messenger wire needed to be adjusted.

Updates will be made as information is available.

Please continue to check this site for additional updates.

Revised 8/31/01 at 10:07 p.m. (HST)



## Safety Zone Reminder

CPF HOME EHIME MARU RECOVERY NEWS

### U.S. Pacific Fleet Public Affairs

---

PEARL HARBOR, Hawaii (Aug 31, 2001) -- The public is reminded that the Ehime Maru recovery operation takes place in restricted areas to ensure the safety of everyone involved.

The Federal Aviation Administration (FAA) has created a temporary flight restriction (TFR) for the deep-water recovery and deep-water relocation sites that extends to an altitude of 2,000 feet and covers a radius of three nautical miles centered on Ehime Maru's location. The TFR will also follow Ehime Maru as it is moved. Normal FAA flight restrictions requiring air traffic control approval from Honolulu International Airport will exist once Ehime Maru has been moved to the shallow-water recovery site about one nautical mile south of the airport's Reef Runway.

The Coast Guard maintains a surface safety zone extending one nautical mile in all directions from Rockwater 2. The safety zone will move with Rockwater 2 as it transports Ehime Maru from its current location about nine nautical miles south of Diamond Head to the shallow-water recovery site. Entry into the zone is prohibited unless authorized by the Coast Guard Captain of the Port. Any person entering the Coast Guard safety zone without permission of the Coast Guard Captain of the Port is subject to a civil penalty of up to \$27,500 and/or criminal penalties up to \$50,000 and up to five years imprisonment or both.

The shallow-water recovery site is within the Navy's existing Naval Defense Sea Area (NDSA). Established in 1942 for the protection of assets located within a military installation, the NDSA extends three nautical miles south of the reef runway and runs 3.5 miles west to Iroquois Point. The sea area will help ensure the safety of divers and others involved in the recovery operation. Only ships or other craft authorized by the Secretary of the Navy will be authorized in this area. Any person violating the NSDA can be subject to federal prosecution.

Any questions concerning the Coast Guard safety zone can be answered by calling 808-541-2450. For questions related to the FAA's temporary flight restrictions the public should call 808-840-6202.

Revised 8/31/01 at 4:37 p.m. (HST)

## ROCKWATER 2 Returns to Load Stern Lift Strap

CPF HOME EHIME MARU RECOVERY NEWS

### U.S. Pacific Fleet Public Affairs

---

PEARL HARBOR, Hawaii (Sep 1, 2001) -- Rockwater 2 will return to port Sept. 1 to load a replacement lifting strap for the stern of Ehime Maru.

The stern lift strap broke after 6 p.m. Aug. 31 while Ehime Maru was lifted approximately 24 feet off the sea floor so the forward messenger wire could be repositioned under the hull.

Remotely operated vehicles conducted a thorough survey of Ehime Maru once the sediment stirred up during the operation settled. From the survey, engineers have determined that Ehime Maru sustained no additional damage and there was no significant release of diesel fuel. During an over flight just after sunrise this morning, a Navy contracted helicopter reported a light sheen slightly smaller than Rockwater 2 south west of the ship. According to a National Oceanographic and Atmospheric Administration formula, this represents less than 3 quarts of diesel fuel.

While in port, Rockwater 2 will load another stern lift strap and rig it to the lift wire of the starboard main winch. This will greatly simplify underwater rigging once Rockwater 2 returns to the deep-water recovery site. The replacement strap is reinforced with two 77mm wires affixed to its underside.

Rockwater 2 will return to the deep-water recovery site Sep. 2.

Revised 9/1/01 at 12:35 p.m. (HST)

## **ROCKWATER 2 Returns to Port**

**CPF HOME EHIME MARU RECOVERY NEWS**

### **U.S. Pacific Fleet Public Affairs**

---

PEARL HARBOR, Hawaii (Sep 1, 2001) -- Rockwater 2 will return to port early this evening to swap out equipment before beginning an alternate means of rigging Ehime Maru for lifting. Rockwater 2 will first stop at the shallow water recovery site to secure the colied tube-drilling unit that is suspended beneath the ship. It will also bring the stern lifting strap up on deck.

At 9 p.m. Tuesday, Sep. 4, the stern lift strap split while Ehime Maru's stern was raised about 24 feet. Reinforcing wires worked as planned and prevented the vessel's stern from falling to the sea bottom. Ehime Maru was safely lowered to the bottom, resulting in no additional damage and no significant release of diesel fuel.

Once Rockwater 2 is in port, Navy and contract engineers will review other methods of placing the lifting plates under Ehime Maru and load the necessary equipment on the ship.

When plans for this phase of the recovery operation are complete, the Navy will brief media on the revised schedule and explain the next steps to be taken. The Navy stands firm in its commitment to transport Ehime Maru to the shallow water recovery site to enable divers to search for the missing crewmembers and their personal effects.

Please continue to check this site for additional updates.

Revised 9/5/01 at 1:35 p.m. (HST)

# Japan's Minister for Foreign Affairs to Visit EHIME MARU Recovery Effort

CPF HOME EHIME MARU RECOVERY NEWS

## U.S. Pacific Fleet Public Affairs

---

PEARL HARBOR, Hawaii (Sep 7, 2001) -- Mrs. Makiko Tanaka, Japan's Minister for Foreign Affairs, will visit Navy personnel involved with the Ehime Maru recovery operation on Sunday, Sept. 9. Adm. Thomas B. Fargo, commander of the U.S. Pacific Fleet, will greet Mrs. Tanaka pierside at the Navy diving complex on Navy Region Hawaii. From the pier, they will observe Mobile Diving and Salvage Unit One's divers training off of the Crowley 450 barge. Media will be pre-positioned along the pier to observe both the greeting and the training. Media may bring two photographers, one positioned on the pier and one on the roof of the media barge. This is a photo-op only, no interviews will be granted.

Mrs. Tanaka will then have a private meeting with Adm. Fargo inside the media barge. At this time, photographers will be invited to take a bus to pre-stage at JDS Chihaya to photograph Mrs. Tanaka's arrival. A pool videographer and pool photographer will be allowed in the conference room before the meeting starts.

Upon conclusion of her meeting with Adm. Fargo, Mrs. Tanaka will depart for JDS Chihaya.

Media need to meet at Pearl Harbor's Personnel Support Detachment (PSD) at 8 a.m. on Sunday to be bused to the pier. We expect the event to conclude and buses to return media to PSD at 10:30 a.m. Media will not be allowed to drive on the base.

Revised 9/7/01 at 5:30 p.m. (HST)

## Updated Cost Estimate

CPF HOME EHIME MARU RECOVERY NEWS

### U.S. Pacific Fleet Public Affairs

---

PEARL HARBOR, Hawaii (Sep 22, 2001) -- The cost of the Ehime Maru recovery operation has been revised from the original estimate of about \$40 million. That figure was estimated prior to the start of the operation, knowing it would be subject to change depending on engineering and environmental factors.

Such factors have included weather delays caused by heavy seas.

Also the engineering challenges of placing the messenger wires and lifting plates under Ehime Maru (from coiled tube drilling to the stern lift method and finally to the bow lift method now being pursued) has resulted in the increased costs of an extended timeline.

The need for additional equipment associated with these methods represents another increased cost.

As of Sept. 21, the operation has cost roughly \$60 million. But because we cannot forecast further weather delays or additional technological challenges, we cannot speculate on the final dollar figure associated with this operation at this time. Once the recovery operation is concluded, we will be able to provide overall costs.

Revised 9/22/01 at 9:40 a.m. (HST)

## **Anchors in Storage on Vessel's Deck**

**CPF HOME EHIME MARU RECOVERY NEWS**

### **U.S. Pacific Fleet Public Affairs**

---

PEARL HARBOR, Hawaii (Sep 25, 2001) -- Both Ehime Maru's anchors have been cut and are being stored on the ship's foc'sle.

The port and starboard anchor chains were cut and each anchor secured to Ehime Maru's foc'sle on Sept. 24 and Sept. 16, respectively. The anchors were not immediately brought to the surface because continuing with dredging operations was a more efficient use of resources during this phase in the recovery effort. Additionally, the sea state raised safety concerns regarding recovering the anchor from 2,000 feet.

Both anchors are now safely stored on the foc'sle and will be retrieved as part of the recovery effort. It has yet to be determined when the anchors will be brought to the surface. Once retrieved, they will be turned over to the Japanese government, which has requested the anchors for memorials.

As information becomes available, updates will be posted to our web site. Rockwater 2 has completed dredging around the bow and is now using dredge pumps to remove sediment from Ehime Maru's foc'sle. The next major milestone in the recovery operation will be rigging heavy lifting wires around the bow through the vessel's hawse pipes in preparation for the initial lift to reposition Ehime Maru onto level ground. Once that is completed, it can be rigged to be transported to the shallow water recovery site.

Revised 9/25/01 at 2:03 p.m. (HST)

## Alternate Bow Rigging

CPF HOME EHIME MARU RECOVERY NEWS

### U.S. Pacific Fleet Public Affairs

---

PEARL HARBOR, Hawaii (Sep 26, 2001) -- Rockwater 2 will use a slightly different method to rig Ehime Maru's bow so it can be lifted onto a level area of ocean floor. The initial rigging plan Capt. Bert Marsh briefed to media Sept. 7 had separate 77mm cables passing through each hawsepipe – the pipes near a ship's bow through which the anchor chain passes – with a plate at one end to keep it from slipping back out.

The new method has a single 77mm cable doubled over and threaded down the starboard hawsepipe, passing around Ehime Maru's bow, then threaded up the port hawsepipe.

The international engineering team aboard Rockwater 2 consisting of Navy and civilian personnel -- including two structural technical experts from Japan -- determined this alternate method is safer. That's because the brunt of the weight being lifted would be distributed around the bow, which is stronger than just the hawsepipes and backing plates.

Revised 9/26/01 at 11:45 a.m. (HST)

## **ROCKWATER 2 Returns to Load Lifting Frame Assembly**

**CPF HOME EHIME MARU RECOVERY NEWS**

**U.S. Pacific Fleet Public Affairs**

---

PEARL HARBOR, Hawaii (Sep 29, 2001) -- Rockwater 2 will return to Honolulu Harbor today to load the lifting and spreader assembly. That assembly, which will be suspended above Ehime Maru, will distribute Ehime Maru's weight when it is lifted and transported to the shallow-water recovery site about 1 mile south of Honolulu International Airport's Reef Runway.

The assembly is comprised of a top and bottom frame. The top frame or lifting bar will be installed beneath Rockwater 2 while in port. After about three days of work in port, Rockwater 2 will then head to a sheltered area at sea where the bottom frame or spreader assembly will be fastened to the top frame. Once this has been completed, Rockwater 2 will return to the deep-water site to lift Ehime Maru and reposition it on a solid, level area of sea floor.

That should take about six days. Once Ehime Maru is repositioned to level sea floor, the bow will be lifted again to move the forward lifting plate into place under the hull in the vicinity of the pilothouse. This will take about one day. Then Rockwater 2 will return to port for about three days to re-rig the forward end of the top lifting frame from a single cable to a double cable lift configuration and then return to the deep-water recovery site.

Rockwater 2 will connect the top and bottom frames and then lift and transport Ehime Maru the roughly 14 nautical miles to the shallow-water site -- contingent on favorable weather conditions -- for diving operations to commence.

Revised 9/29/01 at 11:00 a.m. (HST)



# CHIHAYA's Mission in Recovery Operation Expanded

CPF HOME EHIME MARU RECOVERY NEWS

## U.S. Pacific Fleet Public Affairs

---

PEARL HARBOR, Hawaii (Oct 1, 2001) -- The mission of the Japanese Maritime Self-Defense Force Submarine Rescue Ship Chihaya in the Ehime Maru recovery operation has been expanded to assist in the survey of the deep-water recovery site (DWRS).

In this expanded role, JDS Chihaya will survey the ocean bottom near Ehime Maru's current location for visible items of interest. The search, location and inventory of items from Ehime Maru is the primary mission. JDS Chihaya will also, in coordination with the U.S. Navy, assist in the retrieval of items at the DWRS.

Using a Remotely Operated Vehicle and Deep Submergence Rescue Vehicle, Chihaya has the ability to rapidly survey the deep-water site to speed the Ehime Maru recovery operation and avoid potential problems with unfavorable winter weather conditions.

Chihaya will still serve as a dive platform supporting the JMSDF divers. Divers from Chihaya will assist U.S. Navy divers after Ehime Maru is transported to the shallow water recovery site.

Revised 10/01/01 at 9:35 a.m. (HST)

## Initial Lift Begins

CPF HOME EHIME MARU RECOVERY NEWS

### U.S. Pacific Fleet Public Affairs

---

PEARL HARBOR, Hawaii (Oct 5, 2001) -- Rockwater 2 started to lift Ehime Maru around noon Oct. 5 to place it on a level spot on the sea floor so that it can be prepared for the trip to shallow water. It is not known how long this phase of the operation will take, but media will be updated on the progress.

The goal of this phase is to place a lifting plate under Ehime Maru's hull near the pilothouse while it is still at 2,000 feet. That plate -- and another plate already under the ship's engine room -- will be used to lift Ehime Maru about 100 feet off the ocean floor so it can be transported, while still submerged, to a depth of 115 feet about a mile off Honolulu International Airport's Reef Runway.

Rockwater 2 returned to Honolulu Harbor around 6 p.m. Sept. 29 to load the lifting and spreader assembly. That assembly will be suspended above Ehime Maru and will distribute the ship's weight between the two lifting plates.

Rockwater 2 picked up the top half of the assembly in port, then left around noon Oct. 1 to rendezvous with the Crowley 250 barge in the vicinity of the shallow-water recovery site to pick up the bottom half. The bottom half was placed on the sea floor, then Rockwater 2 lowered the top half to the bottom half so they could be fastened together using a remotely operated vehicle (ROV).

Around 3:15 a.m. Oct. 2, Rockwater 2 headed to Ehime Maru's current location about 9 miles south of Diamond Head with the entire assembly suspended beneath it. Because of its unwieldy load, the ship traveled at 1 knot and did not reach the deep-water recovery site until about 5 p.m. Oct. 2.

Once the forward lifting plate is positioned under the hull, Rockwater 2 will return to Honolulu Harbor with the top half of the assembly. It will remain in port for two to three days to re-rig the forward end of the lifting frame from a single cable to a double cable lift configuration. It will then return to the deep-water recovery site. The bottom half of the assembly will remain above Ehime Maru at the deep-water site connected to the two lifting plates.

Once back at the deep-water site, Rockwater 2 will re-connect the top and bottom frames and then lift and transport Ehime Maru the roughly 14 nautical miles to the shallow-water site -- contingent on favorable weather conditions -- for diving operations to commence.

Revised 10/05/01 at 12:35 p.m. (HST)

# ROCKWATER 2 to Return to Re-rig Lift Assembly

CPF HOME EHIME MARU RECOVERY NEWS

## U.S. Pacific Fleet Public Affairs

---

PEARL HARBOR, Hawaii (Oct 5, 2001) -- At 2:50 p.m. today, Rockwater 2 successfully repositioned Ehime Maru onto the forward lifting plate in preparation for the transit to the shallow-water recovery site.

Ehime Maru was lifted from the ocean floor nearly 10 feet, moved nearly 110 feet to the left and 16.5 feet forward, then lowered onto the plate.

Rockwater 2 will spend the next few days confirming that the plate is properly positioned under the hull in the vicinity of Ehime Maru's pilothouse and connecting the plate to the lifting assembly. It will then disconnect the top half of the assembly from the bottom half and return to Honolulu Harbor for two to three days. While in port, it will re-rig the forward end of the top lifting frame from a single cable to a double cable lift configuration and then return to the deep-water recovery site as outlined in the earlier Oct. 5 media advisory.

Upon its return to the deep-water site, Rockwater 2 will re-connect the top frame to the bottom frame, which remained above Ehime Maru at the deep-water site. It will then lift and transport Ehime Maru the roughly 14 nautical miles to the shallow-water site -- contingent on favorable weather conditions -- for diving operations to commence.

Revised 10/05/01 at 5:35 p.m. (HST)

## **ROCKWATER 2 returns to Reconfigure Lifting Frame Assembly**

**CPF HOME EHIME MARU RECOVERY NEWS**

### **U.S. Pacific Fleet Public Affairs**

---

PEARL HARBOR, Hawaii (Oct 7, 2001) -- Rockwater 2 will return to Honolulu Harbor late on Oct. 7 to re-rig the forward end of the top lifting frame from a single cable to a double cable lift configuration. That lifting and spreader assembly, which will be suspended above Ehime Maru, will distribute the vessel's weight when it is lifted and transported to the shallow-water recovery site about 1 mile south of Honolulu International Airport's Reef Runway. Rockwater 2 is expected to be in port for two to three days and then return to the deep-water recovery site.

After the initial lift on Oct. 5, Rockwater 2 attached the forward lifting plate to the bottom half of the spreader assembly. This bottom frame remains suspended above Ehime Maru at the deep-water recovery site.

Upon returning to the deep-water recovery site, Rockwater 2 will connect the top and bottom frames and then lift and transport Ehime Maru the roughly 14 nautical miles to the shallow-water site -- contingent on favorable weather conditions -- for diving operations to commence. The Navy will brief media on that phase and will notify media of the time and date of the brief in a separate advisory.

Revised 10/07/01 at 12:57 p.m. (HST)

## **ROCKWATER 2 Lifts EHIME MARU**

**CPF HOME EHIME MARU RECOVERY NEWS**

### **U.S. Pacific Fleet Public Affairs**

---

PEARL HARBOR, Hawaii (Oct 12, 2001) -- Rockwater 2 began lifting Ehime Maru at 1:30 a.m., Friday, Oct. 12. Its weight will be distributed by a specially designed lifting and spreader assembly as the vessel is lifted and slowly transported to the shallow-water recovery site about 1 mile south of Honolulu International Airport's Reef Runway.

Rockwater 2 is expected to transit the roughly 14 nautical miles to the shallow-water site -- contingent on favorable weather conditions -- at a speed of 0.2 to 0.5 knots. Ehime Maru will then be placed on the ocean floor in 115 feet of water. No divers will enter the water for 24 hours to ensure Ehime Maru is stable. Divers will then remove debris from the outside of the ship and plug any leaking diesel fuel to protect Hawaii's environment. They will also clear a path for divers to enter the ship.

The Navy will brief media on background at 3 p.m. at the Best Western The Plaza Hotel, 3253 N. Nimitz Hwy., beginning Friday, Oct. 12.

Revised 10/14/01 at 6:35 p.m. (HST)

## **ROCKWATER 2 Sets EHIME MARU Down at Shallow Water Recovery Site**

**CPF HOME EHIME MARU RECOVERY NEWS**

### **U.S. Pacific Fleet Public Affairs**

---

PEARL HARBOR, Hawaii (Oct 14, 2001) -- At 3:22 p.m. on Sunday, Oct. 14, Rockwater 2 successfully set Ehime Maru down on the bottom at the shallow water recovery site one mile south of Honolulu International Airport's Reef Runway.

"The successful relocation of Ehime Maru now opens the window of opportunity to complete our mission of recovery of crew member remains and personal effects," said Rear Adm. Bill Klemm, Ehime Maru recovery operation commander. "We have completed the highest technical risk evolution in our effort and now embark on the highest personnel risk. Safety of our personnel will be our primary driver in the diving operations," according to Klemm.

On Monday morning, Oct. 15, the Navy will move the diving support barge into position over Ehime Maru. Once Ehime Maru has settled for 24 hours, Navy scuba divers will do an external survey of Ehime Maru. Surface supplied diving will begin 24 hours later, with the first task being clearance of hazards and obstructions from the exterior of Ehime Maru.

Revised 10/14/01 at 6:30 p.m. (HST)

# Navy Divers Enter Water, Begin Initial Survey of EHIME MARU's Exterior

CPF HOME EHIME MARU RECOVERY NEWS

## U.S. Pacific Fleet Public Affairs

---

PEARL HARBOR, Hawaii (Oct 15, 2001) -- Shortly after 3:30 p.m. Oct. 15, the first team of two scuba divers from the Navy's Mobile Diving and Salvage Unit One entered the water at the shallow-water recovery site to thoroughly survey Ehime Maru's exterior to ensure the ship is stable and identify any potential hazards.

A second team of two divers were to install two inclinometers -- devices to measure the ship's incline. One inclinometer was to be placed on Ehime Maru's fo'c'sle to measure how much the ship tilts to the left or right. The second was to be installed at the vessel's center point to measure whether it tilts toward the bow or stern. The second team also was to install ladders off Ehime Maru's port side for surface-supplied divers to use once they begin diving. They also were to attach marker buoys to Ehime Maru to identify the position of the ship's bow and stern on the surface.

Surface supplied diving is expected to begin 24 hours following these initial dives to clear hazards and obstructions from the ship's exterior.

At 3:22 p.m. Oct. 14, Rockwater 2 successfully set Ehime Maru down in 115 feet of water at the shallow-water recovery site about 1 mile south of Honolulu International Airport's Reef Runway. On the morning of Oct. 15, the Navy moved the Crowley 450-10 diving support barge into a six-point moor over Ehime Maru. The scuba divers entered the water 24 hours after Ehime Maru first was set down to ensure the ship was resting solidly on the bottom.

A background brief for media is scheduled for 3 p.m. Oct. 16 in the Plumeria Room of the Best Western The Plaza Hotel, 3253 N. Nimitz Hwy.

Revised 10/15/01 at 5:01 p.m. (HST)

# Divers Found and Recovered Remains

CPF HOME EHIME MARU RECOVERY NEWS

## U.S. Pacific Fleet Public Affairs

---

PEARL HARBOR, Hawaii (Oct 16, 2001) -- Today, Navy divers found and recovered the remains of one of the missing from Ehime Maru. The remains have been sent to the medical examiner for identification.

The Ehime Maru was moved to the shallow water recovery site on Sunday, October 14. Divers began their work with an external survey on Monday afternoon, October 15.

Revised 10/16/01 at 8:31 p.m. (HST)



## Divers Locate and Recover Additional Remains

CPF HOME EHIME MARU RECOVERY NEWS

### U.S. Pacific Fleet Public Affairs

---

PEARL HARBOR, Hawaii (Oct 17, 2001) -- Navy divers located two sets of remains in Ehime Maru today and recovered one. Due to safety considerations for the divers and waning daylight, the divers ran out of time on the bottom before they could recover the second set of remains. The recovered remains are being sent to the City and County of Honolulu Medical Examiner for identification. The second set of remains will be recovered tomorrow when divers resume their work.

To date, three sets of remains have been located, of which two sets have been recovered. One crewmember has been positively identified.

The Ehime Maru was moved to the shallow water recovery site on Sunday, Oct. 14. Divers entered the water Monday afternoon, Oct. 15 and were able to recover the first remains on Tuesday.

Revised 10/17/01 at 6:33 p.m. (HST)

## Divers Locate Fourth Remains, Recover Third

CPF HOME EHIME MARU RECOVERY NEWS

### U.S. Pacific Fleet Public Affairs

---

PEARL HARBOR, Hawaii (Oct 18, 2001) -- Navy divers located a fourth set of remains in Ehime Maru today. Divers are hoping to recover this set tonight. Once recovered, the remains will be sent to the City and County of Honolulu Medical Examiner for identification.

The divers recovered the third set of remains earlier and the remains are in the process of being transferred to the Medical Examiner for identification. Once identified, the family will be contacted prior to public release.

To date, four sets of remains have been located, of which two have been recovered and identified. One set has been recovered, but not identified. The fourth has been located, but not yet recovered.

Revised 10/18/01 at 6:03 p.m. (HST)

# Divers Bring Third, Fourth Sets of Remains to Surface

CPF HOME EHIME MARU RECOVERY NEWS

## U.S. Pacific Fleet Public Affairs

---

PEARL HARBOR, Hawaii (Oct 18, 2001) -- Navy divers recovered a fourth set of remains in Ehime Maru today and brought them, along with the remains discovered yesterday, up to the surface. The two sets of remains will be sent to the City and County of Honolulu Medical Examiner for identification. Once the remains are identified by the Medical Examiner, the family will be contacted prior to public release.

To date, four sets of remains have been located and recovered. Two sets of remains have been identified, and two have yet to be identified.

Revised 10/18/01 at 8:03 p.m. (HST)

## Divers Locate, Recover Fifth Remains

CPF HOME EHIME MARU RECOVERY NEWS

### U.S. Pacific Fleet Public Affairs

---

PEARL HARBOR, Hawaii (Oct 19, 2001) -- Navy divers located and recovered a fifth set of remains in Ehime Maru today. The remains will be brought up to the surface and transferred to the City and County of Honolulu Medical Examiner this evening for identification. Once identified, the family will be contacted prior to public release.

To date, five sets of remains have been located, of which four have been identified. One set has been recovered, but not identified.

Revised 10/19/01 at 2:50 p.m. (HST)

## Divers Locate, Recover Sixth Set of Remains

CPF HOME EHIME MARU RECOVERY NEWS

### U.S. Pacific Fleet Public Affairs

---

PEARL HARBOR, Hawaii (Oct 19, 2001) -- Navy divers located and recovered the remains of a sixth individual in Ehime Maru today. The remains have been brought up to the surface and will be transferred to the City and County of Honolulu Medical Examiner this evening for identification. Due to the condition of these remains, a lengthy DNA identification process may be required. Once identified, the family will be contacted prior to public release.

The fifth set of remains was also recovered and transferred to the Medical Examiner for identification.

To date, the remains of six individuals have been located, of which four have been identified. Two sets have been recovered, but not yet identified.

Revised 10/19/01 at 6:50 p.m. (HST)

## **Media Photo Opportunity: Families Review Recovery Operations**

**CPF HOME EHIME MARU RECOVERY NEWS**

### **U.S. Pacific Fleet Public Affairs**

---

PEARL HARBOR, Hawaii (Oct 22, 2001) -- The families of the Ehime Maru's missing crew members will be given an opportunity to review the recovery operations by boat Tuesday, Oct. 23 at 1:30 p.m.

Media will have limited access to this event and will be able to take photos or images of the families and the recovery operations on a separate boat. No media interviews will be conducted.

All media should arrive at Pier 9/10 at 1:15 pm near Aloha Tower, behind The Patriot on Pier 11. Public parking is available at Erwin Park by the Aloha Tower Marketplace. The P&R Water taxi Manao will depart the pier at 1:30 pm. The water taxi will return to the pier at 2:30 p.m.

RSVP is required. Limited space is available. One person allowed per organization. Pending space availability, additional media will be accommodated. Please RSVP Lt.j.g. Choi at (808) 284-1597 or the Ehime Maru recovery operation duty public affairs officer at (808) 286-0585.

Revised 10/22/01 at 3:40 p.m. (HST)

## Divers Locate, Recover Seventh Set of Remains

CPF HOME EHIME MARU RECOVERY NEWS

### U.S. Pacific Fleet Public Affairs

---

PEARL HARBOR, Hawaii (Oct 24, 2001) -- Navy divers located and recovered the remains of a seventh missing crewmember in Ehime Maru today. The remains have been brought up to the surface and will be transferred to the City and County of Honolulu Medical Examiner this evening for identification. Once identified, the family will be contacted prior to public release.

To date, the remains of seven individuals have been located and recovered, of which five have been identified. Two sets have been recovered, but not yet identified.

Revised 10/24/01 at 4:15 p.m. (HST)

## Divers Locate, Recover Eighth Set of Remains

CPF HOME EHIME MARU RECOVERY NEWS

### U.S. Pacific Fleet Public Affairs

---

PEARL HARBOR, Hawaii (Oct 25, 2001) -- Navy divers located and recovered an eighth set of remains in Ehime Maru today. The remains have been sent to the City and County of Honolulu Medical Examiner for identification. Once identified, the family will be contacted prior to public release.

To date, the remains of eight individuals have been located, of which six have been recovered and identified. Two sets have been recovered, but not yet identified.

Revised 10/26/01 at 8:04 a.m. (HST)



# Divers Pause to Repair Spreader Assembly

CPF HOME EHIME MARU RECOVERY NEWS

## U.S. Pacific Fleet Public Affairs

---

PEARL HARBOR, Hawaii (Oct 30, 2001) -- While conducting a routine safety inspection of the spreader bar assembly that was used to move Ehime Maru and is now positioned above the vessel, Navy divers discovered bimetallic corrosion on the assembly's flotation device straps.

The corrosion on these straps, which hold the positively buoyant devices in position, has rendered a potentially unsafe condition for surface supplied diving operations. Surface supplied diving operations have been temporarily suspended until repairs can be completed. The Navy expects to resume diving operations once repairs have been made and all safety requirements have been met.

As a result of these safety concerns, divers exited the water Oct. 30 at 4 p.m. Repairs are expected to take approximately 24 hours.

Revised 10/30/01 at 9:35 p.m. (HST)

## **Divers Repair Spreader Assembly**

**CPF HOME EHIME MARU RECOVERY NEWS**

### **U.S. Pacific Fleet Public Affairs**

---

PEARL HARBOR, Hawaii (Oct 31, 2001) -- Navy divers have successfully repaired the spreader assembly by installing new flotation device restraining straps. Scuba divers from Mobile Diving and Salvage Unit One entered the water Oct. 31 at 9 a.m. and installation of the new straps was completed at 10 a.m.

The corrosion on these straps, which hold the buoyant devices in position, had rendered a potentially unsafe condition for surface supplied diving operations. Surface supplied diving operations were temporarily suspended until repairs were completed. The Navy resumed surface supplied diving operations at 10:10 a.m. after determining that all safety requirements were met.

Revised 10/31/01 at 12:20 p.m. (HST)

# Navy Begins Final EHIME MARU Relocation

CPF HOME EHIME MARU RECOVERY NEWS

## U.S. Pacific Fleet Public Affairs

---

PEARL HARBOR, Hawaii (Nov 24, 2001) -- Ehime Maru began its journey from the shallow-water recovery site to the final relocation site more than 12 nautical miles south of Barbers Point today at 10:44 a.m.

The roughly 21-nautical-mile trip is expected to take about 24 hours, contingent on favorable weather conditions.

The Crowley Maritime 450-10 barge began lifting Ehime Maru from the bottom today. Crowley's tug Sea Valor is towing the 450-10 barge at 1 knot with Ehime Maru suspended about 90 feet below the barge.

Ehime Maru's weight is distributed by the two straps and specially-designed lifting and spreader assembly that supported the ship on its Oct. 12-15 transit from a depth of 2,000 feet about 9 miles south of Diamond Head to the shallow-water recovery site. The shallow-water site was 115 feet deep about 1 mile south of Honolulu International Airport's Reef Runway.

Divers from the Navy's Mobile Diving and Salvage Unit One prepared the ship for its final relocation. These preparations included tapping into a diesel fuel tank on the ship to remove any remaining fuel, but the tank was empty, as predicted. They also removed fishing gear, long line and other material on deck. Internal doors, hatches and ports also were secured to prevent material inside the ship from escaping.

Once at the final relocation site, Ehime Maru will be released in more than 6,000 feet of water. Two pingers were placed on the Ehime Maru prior to its descent. USS Salvor will track the pingers signal and fix the vessel's final position at the close of the operation.

The public is also reminded that the Federal Aviation Administration (FAA) has created a temporary flight restriction (TFR) for the final relocation site that extends to an altitude of 2,000 feet and covers a radius of 3 nautical miles centered on Ehime Maru's location. The U.S. Coast Guard maintains a surface safety zone extending 1 nautical mile in all directions around the vessel working on or moving the Ehime Maru. Any person entering the U.S. Coast Guard surface safety zone without permission of the U.S. Coast Guard Captain of the Port is subject to a civil penalty of up to \$27,500 and/or criminal penalties up of to \$50,000 and up to five years imprisonment or both.

The TFR and surface safety zone will move with the 450-10 barge as it transports Ehime Maru from the shallow water recovery site to the final relocation site. Any questions concerning the Coast Guard surface safety zone can be answered by calling (808)522-8264,

**F/V EHIME MARU Recovery and Relocation Report**

ext. 351. For questions related to the FAA's temporary flight restrictions the public should call 808-840-6202.

Revised 11/24/01 at 12:20 p.m. (HST)

# Navy Begins Final EHIME MARU Relocation

CPF HOME EHIME MARU RECOVERY NEWS

## U.S. Pacific Fleet Public Affairs

---

PEARL HARBOR, Hawaii (Nov 25, 2001) -- The Ehime Maru recovery operation successfully concluded today with the ship settling into its final resting site approximately 12 miles south of Barbers Point in more than 6,000 feet of water.

The Crowley 450-10 barge, which was towed to sea with Ehime Maru suspended off its stern, released the ship at 3:48 p.m.

Representatives of three of the crewmembers' families witnessed the event from the Japanese submarine rescue ship JDS Chihaya, where a short ceremony was held at the time Ehime Maru was released. USS Salvor (ARS 52), a Pearl Harbor-based rescue and salvage ship that participated in the recovery effort, stood by as a mark of respect.

Before Ehime Maru began the day-long journey from the shallow-water recovery site off Honolulu International Airport's Reef Runway, divers from Mobile Diving and Salvage Unit One prepared the ship by ensuring there were no large pockets of diesel fuel onboard and by removing fishing gear, long line and other material on deck. Internal doors, hatches and ports also were secured to prevent material inside the ship from escaping.

The ship was lifted from its 115-foot depth early yesterday and suspended under the Crowley barge for the 21-nautical-mile journey to the final relocation site south of Barbers Point.

Following a request from the Japanese government in mid-February, the operation began in early March with a technical feasibility study. An international team of civilian marine engineers determined that it was possible to lift the 830-ton Ehime Maru from 2,003 feet of seawater and relocate it in 115 feet of seawater where divers could enter the vessel to recover the missing crewmembers.

Once the crewmembers were recovered, the technical feasibility study concluded, Ehime Maru could be lifted a second time for final release at a deep-water site. Upon completion of the study, an environmental assessment -- prepared in close coordination with federal and State of Hawaii agencies -- concluded the recovery effort would not have a significant impact on the environment.

The results of the technical feasibility study and environmental assessment enabled the U.S. Navy to commence with the recovery operation and fulfill this request.

With the determination that the operation would not harm the environment, the Navy contracted with Smit-Tak, a Dutch recovery company, and Crowley Maritime Corp., headquartered in Washington State, to design, engineer and execute the plan to lift Ehime

## **F/V EHIME MARU Recovery and Relocation Report**

Maru off the ocean floor, transport it to shallow water, and relocate it to deep water upon completion of the recovery effort.

While the Navy was confident it would be able to successfully conduct the operation, the recovery was not without risks and there were no guarantees of success. The Navy had recovered aircraft and other items from depths far deeper than 2,000 feet, but this was the first time an object with the mass of Ehime Maru was recovered intact from that depth.

Smit-Tak, the prime contractor for the deep-water rigging and lift to shallow water, had subcontracted with Halliburton Co., a Texas-based engineering and construction company, for the lease of Rockwater 2, a construction support vessel. It was Rockwater 2 that lifted Ehime Maru from 2,000 feet on Oct. 12, then gently set it down at the shallow-water recovery site about 1 mile south of the Reef Runway the afternoon of Oct. 14.

At the shallow-water site, U.S. Navy and U.S. Navy-trained Japanese divers thoroughly searched the ship and recovered eight of the nine missing crewmembers. They also recovered personal effects and items unique to the ship, such as its nameplate, bell and helm, that Japanese government officials had requested for a possible memorial. From Oct. 15 through Nov. 6, the divers completed 425 dives for a total of more than 333 hours of time on the bottom.

Two of Ehime Maru's anchors also were recovered at the deep-water site for the Japanese government.

While those divers were searching the ship, Japan Maritime Self-Defense Force divers from the submarine rescue ship JDS Chihaya were aboard the Crowley barge observing the operation on monitors fed from cameras mounted on the U.S. Navy divers' helmets. The JMSDF divers also spent a week searching Ehime Maru after the U.S. divers were done to verify the thoroughness of the search. They completed 101 dives on Nov. 15 for a total of nearly 70 hours of bottom time.

At a Nov. 15 press conference, Rear Adm. William Klemm, the director of the Ehime Maru Recovery Effort, called Chihaya's commanding officer "a true professional."

"His crew has given it their all, 100 percent," Klemm said. "We have had representatives with their crew and we have seen their helmet camera films (just) as they observed our own people. We know they did a thorough search. I'm very confident that his word is good and that we have searched 100 percent of the ship... ."

In summing up the operation, Klemm said those involved in the operation "have overcome significant technical difficulties in order to provide closure to the families of the missing crewmembers. The gratitude they showed us justified the operation. We are pleased that we were able to recover the remains of eight crewmembers, but our prayers continue to be with the Mizuguchis (the family of the ninth missing crewmember) in their loss."

Revised 11/25/01 at 4:20 p.m. (HST)

## ROCKWATER 2 Fact Sheet

CPF HOME EHIME MARU RECOVERY FACT SHEET

### Information gathered from Halliburton Subsea

---

Aug 1, 2001 -- The Rockwater 2 is a multi-purpose diving support vessel built in 1984 for diving, construction and intervention work. In 1999, the vessel was lengthened, side sponsons added and many vessel systems upgraded.

The vessel fittings include a 150t/250t crane (offshore/harbour capacities) on the port side and a 100t crane sited on the starboard side of the main deck. A 4-point mooring system is serviced by winches at the bow and stern of the vessel.

Diving services are supported by an 18 man saturation diving spread and a 16 man hyperbaric lifeboat. The diesel electric plant includes 5 main generators, 4 in one engine room and 1 in a separate engine room. One emergency/harbour diesel generator is also located in a separate room.

Dynamic Positioning (DP) is provided by the Kongsberg SDP 512 computer control system, with dual control computers and a third monitoring computer. These receive information from a range of reference and sensor systems, and control the functioning of the thrusters; three tunnel thrusters at the bow and two azimuth thrusters aft.

Fully air-conditioned accommodation is available for 106 people. Rockwater 2 is equipped with a helideck certified to take a S61N. The helideck is protected by a foam monitor and fixed water monitors.

Principle Particulars:

Type of Vessel: Monohull DSV

Flag: Bahamian

Port of Reg.: Nassau

Year Delivered: 1984

Built by: BV Scheepswerf "De Hoop", Lobith, Holland

Registered Owner: Breswater Offshore Contracting

Call Sign: C6BM5

## **F/V EHIME MARU Recovery and Relocation Report**

Breadth Mld: 22.00m

Breadth Ext (Helideck): 23.00m

Depth Mld (Main Deck): 7.60m

Draught Max. approx.: 5.30m

Dead-weight Max. approx.:3530t

Displacement Max. approx. 8136t

Main Deck Area approx.: 1150m<sup>2</sup>

This is an official U.S. Navy web site.

Please read this privacy and security notice before entering this site.

Designed and maintained by the Pacific Fleet Public Affairs Office.

Send recommendations and comments to the Fleet Webmaster.

If commenting about a specific page, please include the page title in your correspondence.

Revised 8/1/01 at 5:46 p.m. (HST)



## JDS CHIHAYA Fact Sheet

CPF HOME EHIME MARU RECOVERY FACT SHEET

### Information provided by the Japan Maritime Self Defense Force

---

Aug 20, 2001 -- Chihaya Class (Submarine Rescue Ship) (ASR)

Name: Chihaya

Number: ASR 403

Builders: Mitsui, Tamano

Launched: Oct. 8, 1998

Commissioned: March 2000

Displacement, tons: 5,400 standard

Dimensions, feet (meters): 419.9 x 65.6 x 16.7 (128 x 20 x 5.1)

Main Machinery: 2 Mitsui diesels; 19,500 hp(m) (14.33 MW); 2 shafts; 2 bow and 2 stern thrusters

Speed, knots: 21

Complement: 125

Radars: Navigation: I-band

Helicopters: Platform for up to MH-53 size

Comment: Authorization approved in the 1996 budget as a replacement for Fushimi. Laid down in October 1997. Fitted with a search sonar and carries a DSRV. Also to be used as a hospital ship.

This is an official U.S. Navy web site.

Please read this privacy and security notice before entering this site. Designed and maintained by the Pacific Fleet Public Affairs Office. Send recommendations and comments to the Fleet Webmaster. If commenting about a specific page, please include the page title in your correspondence.

Revised 8/20/01 at 10:46 a.m. (HST)

## Crowley Barge (CMC) 450-10 Fact Sheet

CPF HOME EHIME MARU RECOVERY FACT SHEET

### Information provided by Crowley Maritime Corporation

---

Aug 1, 2001 -- CMC 450-10 is outfitted to work offshore in support of many different types of work. Barge has a large deck area that can be adapted to any application. Vessel is idea for loading out prior to going on work location. The following special features make the barge suitable for extended offshore service with limited support systems.

General Specifications:

Type of Vessel: Accommodation I Work Barge

Port of Registry: Majuro, Marshall Islands

Classification: American Bureau of Shipping +AI Accommodation Barge

Built: 1977 Mitsubishi Heavy Industries Inc. Nagasaki, Japan

Modified: 1998 Accommodations Installed - Atlantic Marine Inc -Jacksonville, FL

Dimensions:

Length: 115.35m 400 feet

Breadth: 30.48m 100 feet

Depth: 7.62m 25 feet

Draft: (max) 5.43 17-07" feet

Gross Tonnage: 8099 tons

Deadweight: 13,000 tons

Open Deck: 1660m (61.5m x 27m)

Deck Load Rating: 10.5 tons sq/m, 2000 Ibs per sq/ft

Casing Racks:

5 Casing racks with hard wood lining

Total Width of all 5 racks: 84 feet x 8'06 height

Rack accepts 42' Casing

Drill Pipe Racks:

5 Drill pipe racks with hard wood lining

Total Width of all 5 racks: 42 feet x 8'06" height

Rack accepts 32' Pipe

Tank Capacity:

Fuel Oil: 5000 BBLs

Fresh Water: 9500 BBLs

Drill Water Ballast: 60,000 BBL's

This is an official U.S. Navy web site.

Please read this privacy and security notice before entering this site.

Designed and maintained by the Pacific Fleet Public Affairs Office.

Send recommendations and comments to the Fleet Webmaster.

If commenting about a specific page, please include the page title in your correspondence.

Revised 8/1/01 at 5:46 p.m. (HST)

## **Admiral Thomas B. Fargo, becomes 29<sup>th</sup> U.S. Pacific Fleet Commander**

**Home                  Facts                  Organization                  Staff                  Adm**

**Page updated at 4:31 p.m. (July 18, Fargo: 2001)  
U.S. Navy [Photo: Official portrait of Adm. Fargo]  
Commander in Chief, U.S. Pacific Fleet**

### **Information provided by the Japan Maritime Self Defense Force**

---

Admiral Thomas Boulton Fargo became the 29th U.S. Pacific Fleet Commander on October 8, 1999. He is responsible for the world's largest combined fleet command, encompassing 102 million square miles and more than 190 ships and submarines, 1,400 aircraft, 191,000 Sailors and Marines, and 30,000 civilians.

Born in San Diego, Calif., in June 1948, Admiral Fargo attended high school in Coronado, Calif., and Sasebo, Japan, and graduated from the United States Naval Academy in June 1970.

Trained in joint, naval and submarine commands, Admiral Fargo has served in a variety of sea and shore duty assignments. At sea, his five assignments in both attack and ballistic missile submarines included Executive Officer aboard USS Plunger (SSN 595) and Commanding Officer of USS Salt Lake City (SSN 716). He served as Commander, Submarine Group SEVEN, Commander Task Force SEVEN FOUR, and Commander Task Force ONE FIVE SEVEN in the Western Pacific, Indian Ocean and Arabian Gulf from 1992 to 1993. Admiral Fargo commanded the United States FIFTH Fleet and Naval Forces of the Central Command during two years of Iraqi contingency operations from July 1996 to July 1998.

Ashore, Admiral Fargo has served in the Bureau of Naval Personnel and with the Commander in Chief, U.S. Atlantic Fleet and has had multiple assignments in the Office of the Chief of Naval Operations.

Since his selection to Flag rank in 1993, Admiral Fargo has served as Director of Operations (J-3), U.S. Atlantic Command during the Haiti intervention; as Director, Assessment Division (N-81) for the Chief of Naval Operations; and most recently as the Deputy Chief of Naval Operations for Plans, Policy and Operations (N3/N5).

Admiral Fargo is a 1989 recipient of the Vice Admiral James Bond Stockdale Award for Inspirational Leadership. His personal decorations include the Distinguished Service Medal (three awards), the Defense Superior Service Medal and the Legion of Merit (three awards).

This is an official U.S. Navy Web site.

Please read this privacy and security notice before entering this site.

Designed and maintained by the Pacific Fleet Public Affairs Office.

Send recommendations and comments to the Fleet Webmaster.

**This page was intentionally left blank.**

# Significant Impact and Environmental Assessment Executive Summary

## Table of Contents

D.1	Finding of No Significant Impact .....	D-2
D.1.1.	Action .....	D-2
D.1.2	Background.....	D-2
D.1.3	Purpose.....	D-2
D.1.4	Description Of Proposed Action .....	D-2
D.1.5	Alternatives Considered.....	D-3
D.1.6	Environmental Effects.....	D-4
D.1.6.1	Water Quality.....	D-5
D.1.6.2	Marine Biological Resources .....	D-5
D.1.6.3	Health and Safety .....	D-6
D.1.6.4	Airspace.....	D-6
D.1.6.5	Hazardous Materials and Hazardous Waste .....	D-7
D.1.6.6	Recovery-Not-Possible Alternative.....	D-8
D.1.7	Conclusion.....	D-8
D.2	Environmental Assessment: Executive Summary .....	D-9
D.2.1	Introduction.....	D-9
D.2.2	Background.....	D-9
D.2.3	Evaluation of Alternative Recovery Methods .....	D-10
D.2.4	Proposed Action and Alternatives .....	D-11
D.2.5	Potential Environmental Effects .....	D-12
D.2.5.1	Current Location.....	D-12
D.2.5.2	Transit to Shallow-Water Recovery Site.....	D-13
D.2.5.3	Recovery Plan (Anticipated Releases).....	D-13
D.2.5.4	Shallow-Water Recovery.....	D-16
D.2.5.5	Relocation to Deep-Water Site .....	D-16
D.2.5.6	Recovery-Not-Possible Alternative.....	D-15
D.2.6	Conclusion.....	D-17
Table D-1	Comparison of Actions and Alternatives .....	D-18

## **D.1 Finding Of No Significant Impact**

Agency: Department Of Defense  
Department Of The Navy

### **D.1.1 Action**

Pursuant to the Council on Environmental Quality regulations (40 *Code of Federal Regulations* Parts 1500-1508) implementing procedural provisions of the National Environmental Policy Act of 1969 as amended (42 United States Code Section 4321 et seq.), the Department of the Navy gives notice that an Environmental Assessment has been prepared for the recovery of EHIME MARU crewmembers, their personal effects, and certain unique characteristic components of the ship and that an Environmental Impact Statement is not required.

### **D.1.2 Background**

On February 9, 2001, USS GREENEVILLE, a Los Angeles class submarine, collided with EHIME MARU, a Japanese fisheries high school training vessel, approximately 9 nautical miles (17 kilometers) south of Diamond Head on the island of Oahu, Hawaii. EHIME MARU sank in approximately 2,000 feet (600 meters) of water. At the time of the sinking, 26 of the 35 crewmembers were rescued. Following an extensive air/sea search, and a sub-sea search and remote-controlled underwater visual inspection of the vessel, it is assumed that some, or all, of the nine missing individuals became trapped inside the vessel or went overboard as the ship went down.

### **D.1.3 Purpose**

The purpose of the Proposed Action will be the recovery of the missing crewmembers, personal effects, and certain unique characteristic components from EHIME MARU, while limiting the impact on the environment. The Proposed Action will be a hazardous and complex deep- and shallow-water operation, because of the depth of the current location and the size of EHIME MARU. The proposed operation has been structured to maximize the probability of recovering crewmembers, personal effects, and items uniquely characteristic of EHIME MARU, while minimizing the risk to the divers, the environment, equipment, and other personnel involved. The purpose of the Proposed Action also includes the safe removal, to the maximum extent practicable, of diesel fuel, lubricating oil, loose debris, and any other materials that may degrade the marine environment, and the relocation of EHIME MARU to a deep-water site. This is not a salvage operation to recover the ship.

### **D.1.4 Description Of Proposed Action**

The U.S. Navy proposes to recover EHIME MARU crewmembers, personal effects, and certain characteristic components unique to the ship (such as the anchors, forward mast, placard, and ship's wheel) by moving the vessel to a shallow-water area to permit safe diver access and recovery operations. To the extent practicable, the deck of EHIME MARU will



be cleared of cargo nets, fishing hooks and long lines, rafts, rigging on the masts, and any other obstacles that could cause an impact to the marine environment or jeopardize the success of the recovery operations. The Navy will use a specially equipped offshore construction vessel to attempt to lift and move EHIME MARU from its current location. Flexible lifting plates will be placed under EHIME MARU to lift it clear of the seafloor using a sophisticated rigging system attached to heavy wire cables and linear winches mounted on the heavy-lift vessel. If the lift is successful, EHIME MARU will then be transported, while suspended from the heavy-lift vessel, to a shallow-water recovery site near the Honolulu International Airport Reef Runway in water approximately 115 feet (35 meters) deep. EHIME MARU will then be placed on the seafloor, where containment booms and skimmer systems will have been pre-positioned with the purpose of containing any diesel fuel or lubricating oil that may be released. The heavy-lift vessel will detach from EHIME MARU and will be replaced by a diving support barge. When EHIME MARU is deemed stable, Navy divers and invited Japanese divers from Ship Repair Facility, Yokosuka, Japan will enter the hull and attempt recovery of crewmembers, any personal effects, and other uniquely characteristic components. They will also attempt to remove remaining diesel fuel and lubricating oil to the maximum extent practicable. EHIME MARU will then be lifted from the seafloor and relocated to a deep-water site at a depth of at least 1,000 fathoms (6,000 feet [1,800 meters]) and outside U.S. territorial waters.

Although this recovery operation has been deemed technically feasible, the proposed engineering solutions are untested in this type of operation. Engineers and salvage experts have based their feasibility assessment upon estimates and calculations on the size of the hole in EHIME MARU and their considered opinion on the anticipated structural integrity of EHIME MARU. However, since they have done these calculations and estimates without having seen the damage to EHIME MARU because the vessel sits upright in 2,000 feet (600 meters) of water, there is some uncertainty as to the exact level of damage. Unplanned occurrences such as structural failure could preclude continuation of the mission at any point during the operation. Such occurrences will cause the Navy to reevaluate whether recovery operations should be continued or terminated, based on the existing situation at the given time and the probability of successfully completing the proposed recovery operations. The Navy will attempt to recover as many crewmembers, personal effects, and other objects as possible.

### **D.1.5 Alternatives Considered**

Three alternative methods of recovering the crewmembers were considered but determined not to be technically feasible or safe. Thus, they were not studied in detail for analysis in the Environmental Assessment. These alternatives included deep-water recovery at the present site, recovery while the vessel was lifted and suspended from the offshore recovery vessel, and recovery out of water. Four additional shallow-water recovery sites were also considered but were not analyzed fully because of their inability to meet mission requirements and because of safety and environmental concerns. Per the requirements of the National Environmental Policy Act, a Recovery-not-possible Alternative, or the “No Action Alternative” was also considered that would leave EHIME MARU in its current location and condition.

### **D.1.6 Environmental Effects**

Consistent with the Council on Environmental Quality regulations, the scope of the analysis presented in the Environmental Assessment was defined by the range of potential environmental impacts that could result from implementation of the Proposed Action or the Recovery-not-possible Alternative. The criterion for inclusion or exclusion of particular environmental components and their attributes was whether the Proposed Action or the Recovery-not-possible Alternative could potentially impact, directly or indirectly, that environmental component and its attributes.

The Environmental Assessment evaluated the following resource areas in detail: water quality; marine biological resources, including coral reefs; health and safety; hazardous materials and hazardous wastes; and airspace use. Ocean areas outside U.S. territorial waters were addressed as required by Executive Order 12114. In terms of air quality, while there will be mobile emissions from the ships, barges, spotter planes, and helicopters involved in the operation, there will be no stationary source emissions. Furthermore, there will be no hazardous or toxic air pollutants from stationary emissions not covered by the National Ambient Air Quality Standards or the National Emission Standards for hazardous air pollutants. Terrestrial biological resources will not be affected since all activities will be confined to either deep-water or shallow-water areas off the coast of Oahu. There are no areas of concern for cultural and archaeological resources, historic buildings and structures, or traditional cultural properties. There are no areas of ethnic importance that could be affected. Similarly, there will be no adverse impacts to land, geology (local physiography, topography, geological resources), or soils. There will be no impacts to land use, or any conflicts with land use plans, policies, or controls. There may be some noise associated with the operations, but any noise will be short-term, intermittent, and no different from regular ongoing vessel and aircraft noise in the area.

With such a short time frame for implementing the Proposed Action, the potential for adverse socioeconomic impacts to income, population, housing, community services, and infrastructure will not exist. No transportation-related impacts to road, rail, air, or water modes are expected, and the Proposed Action will have no effect on local utilities in terms of their energy, potable water, wastewater or solid waste processing and distribution capacities, storage capacities, average daily consumption, or peak demand loads. Lastly, no permanent change to the existing character of the landscape or scenic viewshed will occur, and thus there will be no impacts to visual and aesthetic resources.

Due to the limited scope and nature of the recovery operation, only water quality, marine biological resources, public health and safety, and airspace are likely to be affected by recovery activities. The greatest potential for effects to water quality, marine biology, and health and safety is from hazardous materials such as diesel fuel or lubricating oil escaping from EHIME MARU during lifting, transit, or shallow-water recovery operations. These potential environmental effects are summarized below for the Proposed Action and the Recovery-not-possible Alternative.

### **D.1.6.1 Water Quality**

The Proposed Action is not expected to measurably alter biologically important parameters of water quality including salinity, temperature, pH, density, and dissolved gases except in the immediate area of a potential diesel fuel or lubricating oil release. Potential effects to physical and chemical water quality are judged to be minimal because they will be localized and transitory and subject to planned response actions and weathering. Additionally, if the Proposed Action is successful, by removing as much diesel fuel and lubricating oil as practicable from the ship, there will be a long-term beneficial effect on marine water quality.

### **D.1.6.2 Marine Biological Resources**

The Proposed Action is not expected to adversely impact the Essential Fish Habitat for pelagic management unit species or any other designated Essential Fish Habitat. The greatest potential for impacts will come with the lifting of EHIME MARU from the seafloor and as it is relocated from the current location to the shallow-water recovery site. Any release of this type is expected to rise to the surface, spread out, and rapidly evaporate. In addition, boom systems and skimmer vessels will already be deployed in accordance with the Proposed Action with the intent of containing the potential release of diesel fuel and lubricating oil. The execution of the Proposed Action, including measures incorporated to address anticipated releases of diesel fuel and lubricating oil, will minimize the potential for impacts to marine fish and Essential Fish Habitat. For the recovery operations, the Navy will also take every precaution to minimize impacts to marine biological resources. These steps include notifying the appropriate resource agencies to attempt to administer necessary assistance if birds, marine mammals, or sea turtles should come in contact with a diesel fuel or lubricating oil release.

The U.S. Fish and Wildlife Service will conduct pre-recovery and post-recovery surveys of three areas on Oahu and one on the island of Kauai to identify any oiled birds. In addition, U.S. Fish and Wildlife Service and/or National Marine Fisheries Service observers will be stationed on the skimmer vessel to identify any birds, mammals, or sea turtles that may come in contact with the diesel fuel or lubricating oil from a release. In accordance with the Proposed Action, if it is possible, oiled birds will be stabilized and delivered to a rehabilitation facility. Notifications will be made to the National Marine Fisheries Service should mammals or sea turtles be oiled. The International Bird Rescue Research Center will be contracted for technical assistance with rescue and rehabilitation of oiled birds. Overall potential impacts to migratory seabirds are unlikely. The threatened green sea turtle may be in the area of the current location only as a transient from one island to another. The endangered hawksbill turtle may also be in Hawaiian waters in very low numbers. Because of the low probability for either of these species to be in the area of the current location at any particular time, the activities of lifting EHIME MARU at the current location are expected to have no effect on the green sea turtle or the hawksbill sea turtle. The U.S. Fish and Wildlife Service and the National Marine Fisheries Service concur with this assessment.

### **D.1.6.3 Health and Safety**

The potential impacts to both public and worker health and safety associated with underwater recovery operations will occur on the sea and on the shore. Any release of diesel fuel or lubricating oil will be quickly responded to, thus minimizing risk to public health and safety. Both the U.S. Navy and the contractors associated with the recovery of EHIME MARU have safety policies and procedures relating to the performance of all activities within the scope of their operations. Inclement weather conditions could also pose a potential safety hazard. The Navy's Recovery Officer will determine if the weather conditions are potentially hazardous and will utilize available information, past experience, and the operational limits of the heavy-lift vessel to minimize safety risks as a result of inclement weather.

The recovery operation may generate interest from the public. To ensure the protection of all persons and property, a surface safety zone with a radius of 3 nautical miles (approximately 6 kilometers) will be established for operations at the current location and the deep-water relocation site. For the transit areas and the shallow-water recovery site, the surface safety zone will have a radius of 1 nautical mile (approximately 2 kilometers) centered on the operations. Therefore, there will be minimal risk to the public during the activities. To ensure diver safety, all diving operations will be conducted in accordance with The U.S. Navy Diving Manual. Voice communication integrity for the diving recovery operations will be maintained by requesting Honolulu Control Facility minimize air traffic in an area at and below 2,000 feet (approximately 600 meters) with a radius the same as that of the surface safety zone. The vessel will be moved only during daylight hours and during favorable weather conditions to ensure the safety of operation personnel, to minimize the potential for mishaps, and to ensure detection of any "sheen" resulting from the release of diesel fuel or lubricating oil.

A Site Safety and Health Plan has been prepared for all personnel associated with the cleanup of any release of diesel fuel or lubricating oil. The Site Safety and Health Plan focuses on the protection of personnel from serious risks to their physical safety and health while responding to a marine discharge. This plan identifies the potential hazard conditions and outlines the specific safety and health training together with the job skills and procedures appropriate to the responder's role in the response operations. Appropriate personnel involved in the cleanup operation will receive training to ensure their awareness of the Site Safety and Health Plan.

### **D.1.6.4 Airspace**

As part of the Proposed Action, the Federal Aviation Administration will impose a temporary flight restriction in the airspace above the recovery effort operations at the current location, the transit routes, and the deep-water relocation site within U.S. territory. Further, the Federal Aviation Administration may impose a temporary flight restriction in the airspace above the shallow-water recovery site. The temporary flight restrictions, in accordance with federal aviation regulations, will prevent an unsafe congestion of sightseeing aircraft above the operations. It will also ensure that aircraft will not interfere with

communications during the operations. A Notice to Airmen will be issued to alert pilots of the temporary flight restrictions.

Establishing the temporary flight restrictions and releasing the Notice to Airmen will effectively control the airspace above the operations. It will temporarily change the nature of the airspace above the Proposed Action locations but will not adversely impact navigable airspace and operations at Honolulu International Airport. Similarly, the U.S. Coast Guard will enforce surface safety zones as published in the Federal Register and in Notices to Mariners.

#### **D.1.6.5 Hazardous Materials and Hazardous Waste**

As a result of the Proposed Action, the potential impacts from hazardous materials released could occur during transit and recovery operations. These impacts will be associated with any release of diesel fuel or lubricating oil from EHIME MARU; however, the resulting “sheen” could be readily detected since transient recovery would only occur during daylight hours. Such a release could affect water quality, biological resources, and land areas used for a variety of public and private activities. The recovery plan anticipates some release of diesel fuel and lubricating oil and provides measures for control of these anticipated releases. These measures include the use of skimmers, absorbent booms, and aircraft spotters. Incident Action Plans have also been prepared and approved to address unanticipated releases. Additionally, a Unified Command with representatives from the State of Hawaii, the U.S. Coast Guard, and the Navy will be established consistent with the Incident Command System during the lift and movement phase of the operation in order to monitor the execution of the recovery plan and to assist the Navy in the case of an unanticipated release. Overall, given the procedures and equipment that will be in place to respond to a release, only minor impacts are expected.

To assist the Navy in forecasting favorable wind and current conditions, the Navy’s plan is to monitor real-time surface and subsurface currents by data buoys. Buoys will be placed at the edge of the coral fringe, 2 to 3 nautical miles (approximately 4 to 6 kilometers) from the shallow-water recovery site, and at the shallow-water recovery site. The buoys will monitor wind speed and direction, air temperature, surface or subsurface current speed and direction in the water column, and wave height and period. These buoys will be in place approximately 30 days before the start of recovery operations. Data from the buoys will help ensure that operations will take place only during weather conditions most favorable for containing a release. Modeling conducted by the National Oceanic and Atmospheric Administration determined optimal sea-state and wind conditions for transit. These models assumed an average wind speed of 10 knots (approximately 20 kilometers per hour) for the shallow water recovery site during ebb and flood tide. The models did not consider the extensive preventative measures such as booming; they only modeled the likely place that diesel fuel would travel should no intervention occur. Overall, these models showed that winds from the east would very likely push some diesel fuel toward the beach during both tidal conditions over a 24-hour period with no intervention. Again with no intervention, winds from the east/northeast could also potentially push diesel fuel toward the beach during either tidal condition over a 24-hour period. Winds from the north or northeast would push the diesel fuel out to sea. Infrequently, light trade wind conditions in the

morning can cause a local onshore wind, or seabreeze, in the afternoon. During an uncontained diesel fuel or lubricating oil release, such a seabreeze could potentially result in the substance washing onshore. Therefore, during the transit to the shallow-water recovery site, the heavy-lift vessel will remain approximately 3 nautical miles (approximately 6 kilometers) from the shallow water recovery site and wait for optimal sea and weather conditions before proceeding. This, coupled with the extensive preventative measures that the Navy will employ, will minimize the potential for any releases to be pushed toward the shore. The potential for transit during easterly winds exists. However, this will only occur when other sea conditions (tide, current, sea state) are predicted to be as favorable as possible. Skimmer systems and containment booms will be in place if decisions must be made to transit with easterly winds, thus minimizing potential impacts to the environment. Because there is the potential that not all the diesel fuel and lubricating oil can be removed during the recovery effort, skimmer vessels will be on standby and periodic aircraft overflights will be made to identify any surface sheens. Discovery of such releases is enhanced by operations occurring only during daylight hours, so the Navy will only move the ship during daylight hours. During transit to the deep-water relocation site, the nearby South Oahu Ocean Dredged Material Disposal Site will be avoided. Because of the procedures and equipment that will be in place, no adverse impacts are expected.

#### **D.1.6.6 Recovery-Not-Possible Alternative**

If the Recovery-not-possible Alternative is chosen, EHIME MARU will remain at its current location and in its present condition. This alternative will not allow for the recovery of crewmembers, their personal effects, and certain characteristic components unique to EHIME MARU, such as the anchors, forward mast, placard, and ship's wheel. There will be no removal of diesel fuel and lubricating oil. The deck will not be cleared of cargo nets, fishing hooks and long lines, rafts, rigging on the masts, and any other obstacles that could cause a future impact to the marine environment. However, this alternative will eliminate the potential for a release of diesel fuel or lubricating oil close to shore because the ship will not be moved. No impacts to marine resources including Essential Fish Habitat, migratory birds, marine mammals, or threatened or endangered species are expected from this alternative. Under this alternative, because of the current location at 2,000 feet (600 meters), there will be no increased risk to public health and safety. Under this alternative, no temporary flight restrictions will be required. Consequently, there will be no impacts to controlled/uncontrolled airspace, enroute low altitude airways, or airports or airfields in the general airspace use region. This alternative will not allow for the recovery of potentially remaining hazardous materials that could affect the environment.

#### **D.1.7 Conclusion**

Based on the information gathered during preparation of the Environmental Assessment, the Department of the Navy finds that the Proposed Action will not result in significant environmental impacts. Therefore, an Environmental Impact Statement is not required. To request a copy of the Environmental Assessment, please call toll free 866-617-0797 and leave a message with your name and mailing address. A limited number of copies of the Environmental Assessment are available to fill single-copy requests. The Environmental Assessment may be viewed on the Internet ([www.cpf.navy.mil](http://www.cpf.navy.mil)), at public

libraries in the City of Honolulu, and at the University of Hawaii library. Dated: June 15, 2001 THOMAS B. FARGO Admiral, USN Commander in Chief, U.S. Pacific Fleet

## **D.2 Environmental Assessment: Executive Summary**

### **D.2.1 Introduction**

This Environmental Assessment is being prepared to evaluate the potential environmental effects of the U.S. Navy's proposal to lift the Japanese ship EHIME MARU from the seafloor, transport the vessel to a shallow-water site in order to recover the crewmembers, and then permanently relocate the ship to a deep-water site. Preparation of the Environmental Assessment implements U.S. law and policy, contained in the National Environmental Policy Act and its implementing regulations, to consider the potential environmental effects of federal actions as part of the agency's decision processes. The analysis in the Environmental Assessment will assist Navy officials in making informed decisions concerning recovery of EHIME MARU crewmembers, their personal effects, and certain unique characteristic components of the ship (such as the anchors, forward mast, placard, and ship's wheel), while minimizing the risk to divers, the environment, equipment, and other personnel involved. The Proposed Action would also include the safe removal, to the maximum extent practicable, of diesel fuel, lubricating oil, loose debris, and any other materials that may degrade the marine environment, and the relocation of EHIME MARU to a deep-water site. This is not a salvage operation to recover the ship.

### **D.2.2. Background**

On February 9, 2001, USS GREENEVILLE, a Los Angeles class submarine, collided with EHIME MARU, a Japanese training and fishing vessel, approximately 9 nautical miles (17 kilometers) south of Diamond Head on the island of Oahu, Hawaii (figure D-1). EHIME MARU sank in approximately 2,000 feet (600 meters) of water. At the time of the sinking, 26 of the 35 crewmembers were rescued. However, despite an extensive air and sea search for the nine remaining crewmembers, the Navy was unable to locate them, and it is presumed that they were trapped inside the vessel or went overboard as the ship went down. The vessel is resting upright on the seafloor at 21 degrees 04.8 minutes North latitude, 157 degrees 49.5 minutes West longitude, outside of state of Hawaii waters. The Navy and the Commanding Officer, USS Greenville, have accepted full responsibility for the collision and its result.

Following communication with the Government of Japan to determine the desires of the families of the missing crewmembers, the Navy has agreed and is determined to make all reasonable efforts for the recovery of EHIME MARU crewmembers, their personal effects, and certain unique characteristic components of the ship.

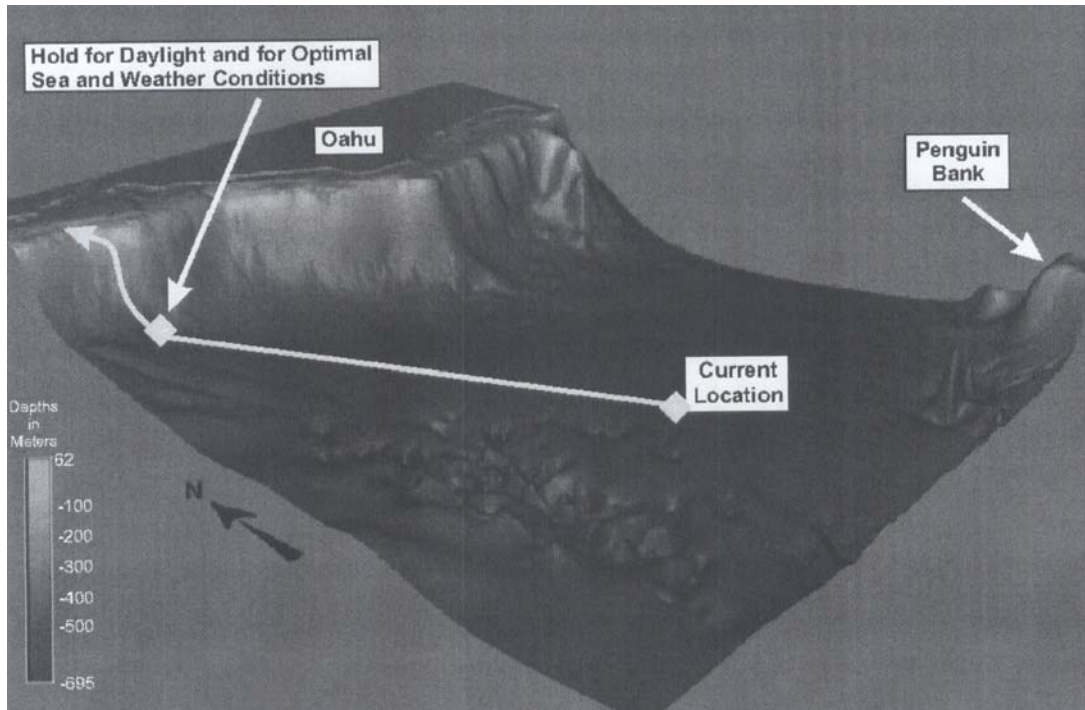

Figure D-1. Current Location of EHIME MARU (not to scale).

### D.2.3 Evaluation of Alternative Recovery Methods

The Navy assembled a diverse and knowledgeable team of experts to evaluate the feasibility and effects of alternative methods of conducting recovery operations. Using Remotely Operated Vehicles with video cameras, the Navy was able to determine that EHIME MARU had suffered obvious external hull damage. Although the bottom of the hull is not visible, it is expected that the vessel has a large hole in the bottom of the hull near its stern, caused by the rudder of the Navy submarine. This was the likely cause of the rapid sinking of the vessel. It is also assumed that the force of the collision opened the vessel's bulkheads and that fuel tanks and other closed containers were crushed by the enormous change in pressure caused by the rapid sinking of the vessel to its present 2,000-foot (600-meter) depth. Consequently, it is possible that a substantial quantity of diesel fuel and lubricating oil has leaked out of the storage tanks and has collected in pockets within the vessel's hull.

Due to the extensive structural damage to EHIME MARU, the Navy determined that a number of potential recovery methods were not feasible. The use of Remotely Operated Vehicles is not feasible because they do not have the capability to cut through obstructions or to enter closed compartments to make a thorough search for the crewmembers. Similarly, available saturation diver systems are not capable of conducting recovery operations at the 2,000-foot (600-meter) depth. Unprotected divers cannot work at a 2,000-foot (600-meter) depth. Consequently, the Navy considered lifting EHIME MARU from the seafloor and suspending it within 100 feet (30 meters) of the heavy-lift vessel and



using divers to recover crewmembers and personal effects while EHIME MARU was suspended in the open ocean. However, the Navy rejected this alternative because its experts concluded that there was an unacceptable risk to the lives of divers involved in the recovery effort.

The Navy also considered a number of alternative ways of removing EHIME MARU from the water to conduct recovery activities. However, none of these alternatives were considered feasible due to the structural damage to the vessel's hull and the unavailability of an effective method to transport or transfer the vessel to an out-of-water site for recovery operations. Furthermore, the risks to Hawaii's pristine environment were considered too great to attempt to transfer EHIME MARU out of the water.

#### **D.2.4 Proposed Action and Alternatives**

The Navy proposes to lift EHIME MARU approximately 100 feet (30 meters) off the seafloor with specially designed equipment and lifting mechanisms. While suspended in the water approximately 100 feet (30 meters) above the seafloor, the vessel would be transported to a shallow-water recovery area only during daylight hours. Once stabilized at a shallow-water recovery area, a team of American and invited Japanese divers would conduct a thorough search of all safely accessible areas of the vessel in order to find and recover the crewmembers and personal effects. While searching, the divers would videotape all of their activities. The Navy would then attempt to remove diesel fuel and lubricating oil and other materials that could adversely affect the marine environment. After inviting Japanese divers to conduct a final search of the ship, the Navy would secure compartments and openings in the vessel to prevent loose material from escaping and would transport EHIME MARU to a deep-water relocation site.

The Navy, with the assistance of state and federal agencies, conducted extensive surveys and analyses of potential shallow-water recovery sites to determine which sites warranted further consideration and analysis in this Environmental Assessment. Five sites were initially identified as potential shallow-water recovery sites. They included a site adjacent to the Honolulu International Airport Reef Runway, a site off Ewa Beach west of the entrance to Pearl Harbor, a site on the Waianae Coast north of Barbers Point Harbor, and two sites off of Molokai, one just east-southeast of Laau Point and the other on the western edge of Penguin Bank. The Navy determined that the Penguin Bank site would present an unacceptable risk to divers during recovery operations due to hazardous sea-state conditions. Both Molokai sites are also located within the Hawaiian Islands Humpback Whale National Marine Sanctuary. Consequently, these sites were not given further consideration and are not evaluated for environmental effects in this Environmental Assessment. Following a further evaluation of the remaining three sites, including safety, security, environmental and logistical considerations, the Navy identified the Reef Runway site as its preferred site for conducting shallow-water recovery operations.

The site that the Navy is considering for deep-water relocation of EHIME MARU is southwest of the Reef Runway shallow-water recovery site just beyond the 1,000-fathom (6,000-foot, 1,800-meter) contour and outside U.S. territorial waters. Although this recovery operation has been deemed technically feasible, the proposed engineering solutions are

untested in this type of operation. Engineers and salvage experts have based their feasibility assessment upon estimates and calculations on the size of the hole in EHIME MARU and their considered opinion on the anticipated structural integrity of EHIME MARU. However, since they have done these calculations and estimates without having seen the damage to EHIME MARU (the vessel sits upright in 2,000 feet [600 meters] of water), there is some uncertainty as to the exact level of damage. Although there are risks and potential structural damage that could prevent the Navy from successfully achieving its goal, the Navy is confident that it could lift and move EHIME MARU to a shallow-water site for recovery of the crewmembers and would make every reasonable effort to do so. At various critical points in the Proposed Action, structural failure could preclude continuation of the mission. Unplanned occurrences such as this would cause the Navy to reevaluate whether recovery operations should continue or be terminated based on feasibility and probability of crewmember recovery. Depending upon where a failure might occur and if the Proposed Action were stopped, the Navy would attempt to recover as many crewmembers, personal effects, and other objects as possible. To the maximum extent practicable, these objects would include the cargo nets, fishing hooks and long lines, rafts, rigging on the masts, and any other obstacles that could cause a future impact to the marine environment. Extreme structural damage, if present, would prevent the vessel being moved intact and thus would prevent the Navy from conducting the planned recovery operations.

This recovery operation is not without risks, and there is no guarantee of success. Because of the nature and uniqueness of the Proposed Action, engineering methods continue to mature. As specific changes are developed they would be evaluated within the context of the Proposed Action. If the changes introduce a potential for environmental effects that are substantially different, then additional environmental documentation would be prepared. In accordance with the requirements of National Environmental Policy Act, a Recovery-not-possible Alternative was also considered that would leave EHIME MARU in its current location and present condition.

### **D.2.5 Potential Environmental Effects**

Due to the limited scope and nature of the recovery operation, only water quality, marine biological resources, public health and safety, and airspace are likely to be affected by recovery activities. The greatest potential for effects to water quality, marine biology, and health and safety would result from hazardous materials, such as diesel fuel or lubricating oil escaping from EHIME MARU during lifting, transit, or shallow-water recovery operations. These potential environmental effects are summarized below.

#### **D.2.5.1 Current Location**

At the time of the collision with the Navy submarine, EHIME MARU carried approximately 65,000 gallons (246,000 liters) of diesel fuel, 1,200 gallons (4,500 liters) of lubricating oil, and 46 gallons (182 liters) of kerosene, as well as smaller quantities of other materials, such as paints, solvents, and chemicals. No polychlorinated biphenyls (PCBs) or asbestos were aboard or used in the ship's construction or equipment. Based on aerial observations for 3 days following the collision, the Navy has conservatively estimated that

the volume potentially remaining, and thus the maximum credible release, would be approximately 45,000 gallons (170,000 liters).

There is no evident long-term adverse effect on the marine environment from the previously released petroleum products. Any release of diesel fuel or lubricating oil during efforts to lift EHIME MARU would occur deep in the ocean and would likely disperse in the water column with little, if any, visible effect at the surface. However, the Navy would have pollution response vessels and materials available to control these releases, should they surface. There would be some disturbance to the area in the immediate vicinity of the vessel during activities to place lifting plates under its hull and to lift it off the bottom. However, any effects on marine organisms would be limited and short term. A surface safety zone with a radius of 3 nautical miles (approximately 6 kilometers) around the heavy-lift vessel and a temporary flight restriction area in airspace up to an altitude of 2,000 feet (approximately 600 meters) would be established to prevent interference with recovery operations. Normal flight activities would not be affected.

#### **D.2.5.2 Transit to Shallow-Water Recovery Site**

There are some characteristics of the ocean bottom (gradient and relief) along the transit route from the current location of EHIME MARU to the shallow-water recovery site that could potentially interfere with the towing clearance. The major concern during transit would be the potential release of contaminants (mainly diesel fuel and lubricating oil) from the vessel into the marine environment. This could temporarily contaminate marine waters and adversely affect marine mammals, migratory birds, and other protected species, such as sea turtles. However, the Navy would minimize the likelihood of harm to any of these protected species by including preventive measures as an integral part of the Proposed Action to contain any release of hazardous materials while in transit. These preventative measures are as follows:

#### **D.2.5.3 Recovery Plan (Anticipated Releases)**

- Incorporating environmental considerations into final site selection within the shallow water recovery area
- Pre- and post-inventories of bird habitat
- Real-time spot weather forecasts
- Removing cargo nets, long line fishing gear, and other equipment that might be lost during transport, prior to initial lift of the vessel
- Availability and use of skimmers and booms
- Oil-plume modeling of wind direction, speed, and sea states necessary to avoid oil on beach
- Provide real-time surface and water-column currents
- Timing the final move to the shallow-water recovery site with favorable wind, current, and tides
- Placing U.S. Fish and Wildlife Service and/or National Marine Fisheries Service personnel on skimmers to respond to oiled bird incidents
- Standing up oiled bird stabilization facilities at Kaneohe or Pearl Harbor

Unanticipated Releases:

- Pre-developed Incident Action Plan
- Standing up Unified Command

Specifically, the Navy would deploy skimmer systems and containment booms during transit and recovery operations to ensure an immediate response capability in the event of a release. The vessel would be moved only during daylight hours and during favorable weather conditions to ensure the safety of operation personnel, to minimize the potential for mishaps, and to ensure detection of any “sheen” resulting from the release of diesel fuel or lubricating oil. A surface safety zone with a radius of 1 nautical mile (approximately 2 kilometers) centered on the recovery vessel during recovery operations would be established to protect the public and prevent interference with recovery operations.

The Federal Aviation Administration may impose a temporary flight restriction in the airspace above the shallow-water recovery site. Normal flight activities would not be affected. Modeling conducted by the National Oceanic and Atmospheric Administration determined optimal sea state and wind conditions for transit. These models assumed an average wind speed of 10 knots (approximately 20 kilometers per hour) for the shallow water recovery site and were run for ebb and flood tidal conditions. This modeling also provided the Navy with an acceptable methodology from which to predict the extent and locations that releases of diesel fuel would travel. Overall, these models showed that winds from the east would very likely push diesel fuel onto the beach during both tidal conditions over a 24-hour period with no intervention. Likewise, with no intervention, winds from the east/northeast could also potentially push diesel fuel onto the beach during either tidal condition over a 24-hour period. Winds from the north or northeast would push the diesel fuel out to sea. Infrequently, light trade wind conditions in the morning can cause a local onshore wind, or seabreeze, in the afternoon.

During an uncontained diesel fuel or lubricating oil release, such a sea breeze, could potentially result in the substance washing on shore. Therefore, during the transit to the shallow-water recovery site, the heavy-lift vessel would remain approximately 3 nautical miles (approximately 6 kilometers) from the shallow water recovery site and wait for optimal sea and weather conditions before proceeding. This, coupled with the extensive preventative measures that the Navy would employ, would minimize the potential for any releases being pushed toward the shore. The potential for transit during easterly winds exists. However, this would only occur when other sea conditions (tide, current, sea state) are predicted to be as favorable as possible. Skimmer systems and containment booms would already be in place or on standby if decisions must be made to transit with easterly winds, thus minimizing potential impacts to the environment.

### **D.2.5.3 Shallow-Water Recovery**

The Reef Runway shallow-water recovery site is close to sensitive shore and beach areas and in relatively shallow water (approximately 115 feet [35 meters] deep).

Consequently, any significant release of diesel fuel or lubricating oil would have greater potential impacts than in deeper water, either at the current location or during transit. However, the Navy has developed extensive plans and procedures, in coordination with state and federal emergency planning agencies, to minimize the potential for environmental impacts at these sites. The Navy would have on-scene containment booms, skimmer systems, and dispersants available to contain and clean up any releases during recovery operations. Every effort would be made to prevent any releases from reaching beach or shore areas.

An Incident Action Plan has also been prepared and approved to address unanticipated releases. Additionally, a Unified Command with representatives from the State of Hawaii, the U.S. Coast Guard, and the Navy would be established, consistent with the Incident Command System, during the lift and relocation phase of the operation in order to monitor the execution of the recovery plan and to assist the Navy in the case of unanticipated release. The U.S. Fish and Wildlife Service would conduct pre-recovery and post-recovery surveys of three areas on Oahu and one on the island of Kauai to identify any oiled birds. In addition, U.S. Fish and Wildlife Service and/or National Marine Fisheries Service observers would be stationed on the skimmer vessel to identify any birds, mammals, or sea turtles that may come in contact with a release. If possible, oiled birds would be stabilized and delivered to a rehabilitation facility. The International Bird Rescue Research Center would be contacted for technical assistance with rescue and rehabilitation of oiled birds. Overall, potential impacts to migratory seabirds are unlikely. Disturbance of marine organisms at the shallow-water recovery site could result from placement and stabilization of EHIME MARU, anchoring of support vessels, and operation of support and recovery equipment. However, these effects would be minimized by careful placement of the hull and mooring system to avoid live coral and sensitive fish and the threatened green sea turtle habitat. The Reef Runway recovery site is a disturbed habitat and, consequently, green sea turtles are not common at that location.

Extensive underwater surveys have been conducted at the shallow-water site to assist Navy and natural resource agencies in identifying specific areas within the site where recovery operations may be conducted with the least impact to live coral, green sea turtles, and other marine organisms on the seafloor. Recovery operations may generate interest from the public. Consequently, measures would be instituted to protect both the public and recovery personnel. It is critical both to their safety and effectiveness that the diving team be able to act and communicate without physical or noise interference from the public. Consequently, the Navy would establish a surface safety zone with a radius of 1 nautical mile (approximately 2 kilometers) around the recovery operations to ensure diver safety. Communications integrity for the recovery operations would be maintained by establishing a temporary flight restriction area at and below an altitude of 2,000 feet (approximately 600 meters) within a radius of 1 nautical mile (approximately 2 kilometers). The Reef Runway recovery site is within the Naval Defense Sea Area controlled by the Navy and is under the active control of the Honolulu Control Facility. In addition, a temporary flight restriction area in the airspace around the site and the release of a Notice to Airmen would be implemented to preclude aircraft intrusion into the area. Recovery operations at the Reef Runway recovery site would not affect scheduled airline flight routes or activities.

Recovery of EHIME MARU crewmembers, their personal effects, and certain unique characteristic components of the ship is the Navy's primary goal. Once this is accomplished, a secondary objective would be to attempt to remove to the maximum extent practicable any remaining diesel fuel, lubricating oil, or other materials that could be hazardous to the marine environment. However, diver safety would be of paramount importance, both in efforts to recover the crewmembers and, subsequently, to remove hazardous materials from the vessel. A Diving Medical Officer and technicians and standby divers would be available on the diving support vessel during all diving activities, which would occur only during daylight hours. Decompression chambers would also be present on the support vessel. In addition, the Fleet Recompression Chamber at Pearl Harbor and local hospitals could be reached within a matter of minutes from the Reef Runway recovery site in the event of an emergency.

#### **D.2.5.4 Relocation to Deep-Water Site**

Following recovery of EHIME MARU crewmembers, their personal effects, certain unique characteristic components, and the removal to the maximum extent practicable of the diesel fuel, lubricating oil, and other known hazardous materials, Japanese divers would be invited to do a final inspection of EHIME MARU. Afterwards, Navy divers would secure doors by any means available to prevent loose material from falling off the vessel during relocation to the deep-water site. The vessel would then be lifted clear of the seafloor by the diving support barge and relocated to the deep-water site, following a previously surveyed route to avoid obstructions and sensitive areas. Navy skimmers and other response equipment would remain available during this phase of the operation to ensure releases of any residual diesel fuel or lubricating oil from the vessel would not adversely affect the marine environment. Upon arrival at the deep-water relocation site outside U.S. territorial waters, EHIME MARU would be released and allowed to sink to the bottom of the sea in over 1,000 fathoms (6,000 feet or 1,800 meters) of water. The vessel would be equipped with a pinger that would assist in identifying EHIME MARU's final location coordinates accurately on the seafloor. The signal from the pinger would be similar to the type used on airplanes and would be localized. Therefore, the pinger would not be expected to adversely affect individual animals and would stop functioning after about 30 days. Relocation to the deep-water site is not expected to result in any noticeable reduction in water quality or have any long-term effect on marine resources or biota.

#### **D.2.5.5 Recovery-Not-Possible Alternative**

Under this alternative, EHIME MARU would not be recovered and would remain at its current location in its present condition. This alternative would not allow for the recovery of potentially remaining hazardous materials that could affect water quality. The deck would not be cleared of cargo nets, fishing hooks and long lines, rafts, rigging on the masts, and any other obstacles that could cause a future impact to the marine environment. However, this alternative would eliminate the potential for a release close to shore because the ship would not be moved. No impacts to marine resources including Essential Fish Habitat, migratory birds, marine mammals, or threatened or endangered species are expected from this alternative. Under this alternative, because of the current location at 2,000 feet (600 meters), there would be no increased risk to public health and safety. This alternative would

not allow for the recovery of potentially remaining hazardous materials that could affect the environment. Under this alternative, no temporary flight restriction would be required. Consequently, there would be no impacts to controlled/uncontrolled airspace, enroute low altitude airways, or airports or airfields in the general airspace use region.

### **D.2.6 Conclusion**

Based on the information gathered during preparation of the Environmental Assessment, the Proposed Action would not result in significant impacts to the environment, as shown in Table D-1.

RESOURCE CATEGORY	PROPOSED ACTION					RECOVERY NOT POSSIBLE ALTERNATIVE
	Current Location	Transit to the Shallow Water Recovery Site	Shallow Water Recovery Site	Transit to the Deep Water Recovery Site	Deep Water Relocation Site	
<b>Water Quality</b>	Appropriate procedures and equipment would be in place to minimize potential impacts to water quality from a diesel fuel or lubricating oil release.	Appropriate procedures and equipment would be in place to minimize potential impacts to water quality from a diesel fuel or lubricating oil release.	Appropriate procedures and equipment would be in place to minimize potential impacts to water quality from a diesel fuel or lubricating oil release at the shallow-water recovery site. No long-term impacts would occur.	Diesel fuel and lubricating oil and other hazardous materials would be removed prior to transit. Appropriate procedures and equipment would be in place to minimize potential impacts to water quality during transit.	Diesel fuel and lubricating oil and other hazardous materials would be removed prior to relocation to minimize potential long-term impact to water quality.	Potential for continued slow release of diesel fuel and lubricating oil remaining on the vessel to affect localized water quality.
<b>Marine Biological Resources</b>	Minimal impact to Essential Fish Habitat or coral, marine mammals, migratory birds, or threatened or endangered species.	Minimal impact to Essential Fish Habitat or coral, marine mammals, migratory birds or threatened or endangered species.	Minimal impact to Essential Fish Habitat or coral, marine mammals, migratory birds, or threatened or endangered species.	Minimal impact to Essential Fish Habitat marine mammals, migratory birds, or threatened or endangered Species.	Minimal impact to Essential Fish Habitat, marine mammals, migratory birds, or threatened or endangered species.	Potential impact from exposed cargo nets, fishing hooks and lines, rafts, and other obstacles.
<b>Health and Safety</b>	Appropriate health and safety procedures and equipment would be in place to minimize risk to worker and public safety.	Appropriate health and safety procedures and equipment would be in place to minimize risk to worker and public safety.	Appropriate health and safety procedures and equipment would be in place to minimize risk to worker and public safety. Activities would occur within existing restricted area, which would minimize risk to diver safety.	Appropriate health and safety procedures and equipment would be in place to minimize risk to worker and public safety.	Appropriate health and safety procedures and equipment would be in place to minimize risk to worker and public safety.	No impact
<b>Hazardous Materials and Hazardous Waste</b>	Procedures and equipment would be in place to minimize impacts from an unanticipated diesel fuel or lubricating oil release.	Procedures and equipment would be in place to minimize impacts from an unanticipated diesel fuel or lubricating oil release.	Procedures and equipment would be in place to minimize impacts from an unanticipated diesel fuel or lubricating oil release.	Oil and other hazardous materials would be removed prior to transit as practicable. Equipment and procedures would be in place to minimize impacts from an unanticipated diesel fuel or lubricating oil release.	Oil and other hazardous materials would be removed prior to relocation as practicable to minimize potential long-term impact.	Potential for continued slow release of diesel fuel or lubricating remaining on the vessel.
<b>Airspace</b>	Establishment of a temporary flight restriction would not impact airspace use.	Establishment of a temporary flight restriction would not impact airspace use.	Establishment of a temporary flight restriction would not impact airspace use.	Establishment of a temporary flight restriction would not impact airspace use.	Establishment of a temporary flight restriction would not impact airspace use.	No impact

**Table D-1. Comparison of Actions and Alternatives.**



## *Appendix E*

# **Correspondence**

### ***Table of Contents***

Feasibility of Recovery of the Japanese Fishing Vessel EHIME MARU .....	E-2
Engineering Analysis of the Feasibility of Salvaging the EHIME MARU .....	E-8
Environmental Protection Plan for EHIME MARU Salvage.....	E-15
Plan for Recovery of the Remains of Crewmembers from the Japanese Fishing Vessel EHIME MARU.....	E-25
CNO Task .....	E-42
Task Organization.....	E-43
Communications Operational Tasking .....	E-47
Overall Operational Tasking .....	E-51
METOC Operational Tasking .....	E-58
SUPSALV Message Sitrep .....	E-64
Logistics Operational Tasking.....	E-68
Medical Operational Tasking.....	E-71
Oil Spill Message .....	E-78

# Feasibility of Recovery of the Japanese Fishing Vessel EHIME MARU

4740

SER00C/0017

21 MAR 2001

From: Commander, Naval Sea System Command

To: Commander and Chief Pacific Fleet

Subj: FEASIBILITY OF RECOVERY OF THE JAPANESE FISHING VESSEL  
EHIME MARU

Ref: (a) COMNAVSURFGRU MIDPAC 051600Z MAR 01

Encl: (1) Narrative description of the plan for recovering the EHIME MARU  
(2) Engineering feasibility report  
(3) Environmental Protection Plan

1. As discussed in reference (a), enclosures (1) through (3) are provided addressing the feasibility of raising the EHIME MARU from a depth of 600 meters off the coast of Oahu. Enclosure (1) provides a description of the plan and addresses several options investigated during its development. With the dual principal goals of recovering the crew members remains and limiting the impact on the environment, the method chosen uses a team of divers to conduct the actual recovery without lifting the vessel through the surface. Engineering calculations summarized in enclosure (2) addressed three areas of concern for the operation:

- Initial heavy lift from 600 meters
- Dynamic loading in a seaway
- Lift through the air sea interface

To eliminate the maximum stress placed on the damaged hull of the EHIME MARU lifting the vessel clear of the water is not recommended. This will also limit the impact on the environment as any fuel or oil currently trapped in the hull will not necessarily be released as would occur if the vessel is lifted clear of the water.

2. A plan for deploying oil spill equipment throughout all phases of the operations is forwarded as enclosure (3). Options for removing the fuel are being considered, but the actual condition of the tanks and piping will determine how and if these measures can be

used effectively. A risk versus reward evaluation, which will include all effected parties, will be conducted once the vessel can be inspected by divers.

3. It is anticipated that recovery will take from five to six months once a lift platform is chartered. This estimate is based on the limited population of vessels with the required capability and their availability and location when chartered.

B. MARSH

Supervisor of Salvage and Diving

Director of Ocean Engineering, USN

## EHIME MARU SALVAGE FEASIBILITY

The fishing vessel EHIME MARU sank in 600 meters, following a collision with USS GREENEVILLE (SSN 772). At the time of the sinking, all but nine of the crewmembers were successfully rescued. Following an extensive air/sea search, and a subsea search and visual inspection of the vessel, it is assumed that some, or all, of the missing crew became trapped inside the vessel and went down with it. Commander In Chief, Pacific Fleet requested that Naval Sea Systems Command, Code 00C (NAVSEA 00C) determine the feasibility of locating and recovering the missing victims.

To accomplish this, NAVSEA 00C tasked SMIT TAK, one of our prime salvage contractors to conduct a feasibility assessment. SMIT TAK was chosen for this task because they have extensive experience in deep ocean, heavy salvage.

The fact that the vessel lies in 600 meters and weighs 740 metric tons makes this the most ambitious salvage effort the Navy has ever undertaken. We initially considered use of saturation divers, but could not find a saturation system that provided that depth capability. Because of this, we concluded that the operation would have to be accomplished utilizing remotely operated vehicles (ROVs).

Having no idea where the victims would be found inside the vessel, we concluded that to attempt to enter the vessel and complete a visual search of all of the spaces, utilizing small ROVs would not be practical. ROVs are controlled from the support ship by commands sent to the vehicle through a tether. While they are very maneuverable in the open water, when confined inside a hull, with limited visibility, it would be extremely difficult to avoid entanglement. Additionally, management of the tether as the vehicle maneuvers inside the hull would be impossible. Completing a thorough visual search of every space in the ship with television cameras is not practical and the probability of success is virtually nil. Additionally, mechanical manipulators and thrusters on small ROVs do not possess the power required to removal obstacles, that will be in the interior of the vessel due to the collision with GREENEVILLE and impact with the ocean floor.

Based on past experience, SMIT TAK provided a feasibility assessment that assumes use of ROVs, an offshore construction vessel and a sheerleg, or fixed crane, to complete the salvage.

## EXPLANATION OF RECOVERY OPERATION

Lift to surface and clump weights left behind

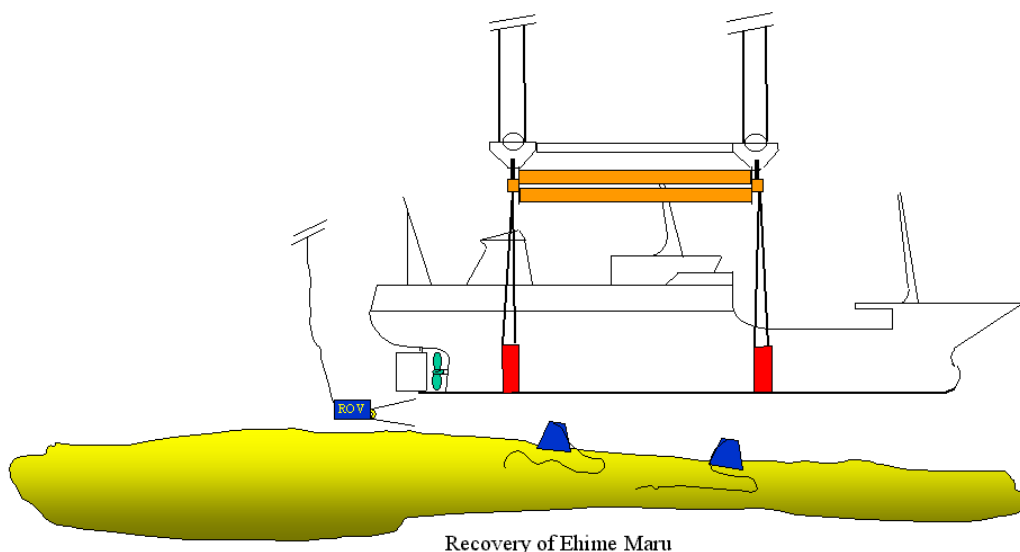

Figure 1.

The basic concept is to rig lifting plates under the EHIME MARU and lift it clear of the seafloor utilizing linear winches mounted on a multi-purpose offshore construction vessel (see Figure 1). It would then be transported to a shallow area, approximately 30 meters deep and placed back on the seafloor. At that point, two options are available. The preferred option is to have Navy divers enter the hull and recover any victims found inside. The hull could then be lifted back off the bottom and transported to a deep-water site offshore for disposal. The other option would be to use a sheerleg to lift the hull out of the water and place it on a barge. It could then be taken into Pearl Harbor and a team could enter it to locate and recover victims. However, this last option significantly increases the risk to the environment.

One of the most challenging parts of the operation will be placing lift plates under the hull. Two concepts have been proposed, both of which appear feasible. One of the options would be to pass a strap under the stern, above the rudder. The ship could then be lifted slightly by the stern to allow for passage of messengers to pull the lift plates under the hull (see figure 2). The other option would be to use a directional drilling technique to drill a path four feet under the hull, and then pull the messengers through. As there is evidence of hull damage in the forward part of the ship at frame 65, NAVSEA engineers carefully reviewed the SMIT analysis of hull strength and the impact of lifting it by the stern. Their conclusion is that the SMIT analysis is valid, and that there is sufficient strength remaining in the hull to withstand the anticipated loads. (A detailed description of the analysis is provided as Enclosure 2). Because directional drilling places no loads on the hull, our initial plan would be to use directional drilling if it proves effective, with the stern lift as a backup.

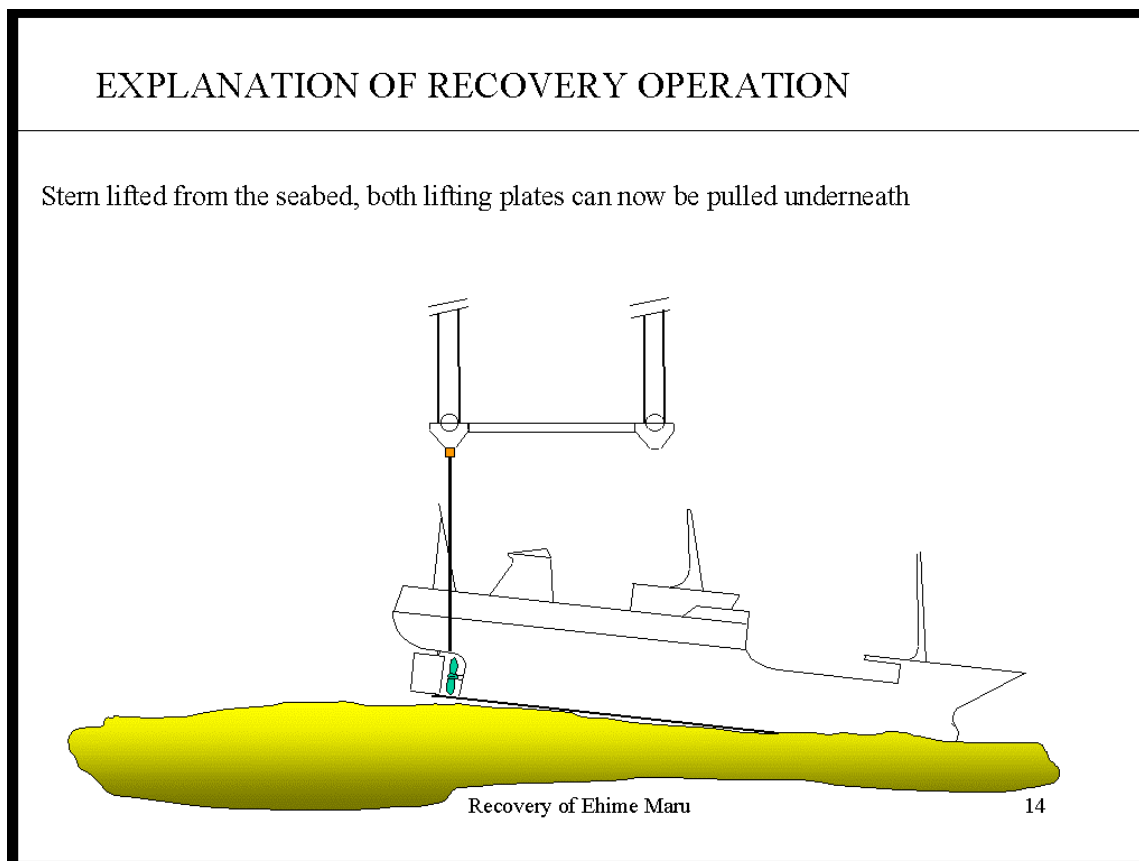

Figure 2.

Lifting the hull off the seafloor is relatively straightforward. SMIT engineers analyzed the dynamics anticipated using a computer program designed for that purpose. Their finding is that if a large, offshore construction vessel is used, and the maximum wave height limited to less than 4 m, the proposed lifting equipment can be safely employed. To preclude any additional damage to EHIME MARU, the wave height limits set by the salvage

team will be approximately 2m. Two 500-ton linear winches will be used to provide the requisite line pull for the lift. Wire ropes of at least 115mm diameter will be utilized, providing an adequate safe working load. A spreader assembly and lifting frame will be used to connect the lift wires to the lifting plates. The hull will be maintained approximately 10 meters off the bottom, and continually monitored by an ROV, while it is being transported to the 30-meter area for inspection by Navy divers.

Because of potential problems obtaining permission to place the hull in 30 meter, we considered placement of the hull on a submersible barge or heavy lift ship, like the M/V BLUE MARLIN. However, the maximum depth at which these vessels can ballast down is approximately 10 meter. Because the keel of EHIME MARU when suspended will be approximately 22 meters below the surface, use of a submersible is not possible. The only other option would be to attempt to transfer the load from the lifting ship to a sheerleg, then placing it on a transport barge while offshore. Though it is technically feasible, it could only be done under the best weather conditions, and still presents an unacceptable risk of loss of the vessel, damage to equipment, or injury to personnel.

To mitigate any potential oil spill a response plan attached as enclosure (3) of the forwarding letter will be instituted during the salvage. Careful consideration will be given to the possibility of removing the remaining fuel once the vessel is placed on the bottom in shallow water. Removal of fuel at 600 meters is not possible, as current technology is limited to a maximum depth of less than 300 meters. It would also require the tanks be relatively undamaged, while those on the EHIME MARU have been exposed to 600 meters or approximately 60 atmospheres of pressure. Removal of the fuel during transit is unsafe, as it would require working on the vessel while it was under strain and in a seaway. Once placed in 30 meters of water a risk versus gain assessment will be conducted. Should persistent fuel leakage occur "hot tapping" or other methods of removal will be attempted. Pressurization damage may cause pocketing of fuel between frames or in web spaces limiting the effectiveness of any removal techniques.

# Engineering Analysis of the Feasibility of Salvaging the EHIME MARU

Provided for The COMMANDER in CHIEF, US PACIFIC FLEET

## Abstract

The logic involved and steps required to determine the feasibility of raising the EHIME MARU from a depth of 600 meters are developed along with the results of relevant calculations. Results of the analysis yielded an executable salvage plan based on a lift of the vessel, transit to a shallow 30 meters area and recovery of crewmember remains using surface supplied divers.

## Table of Contents

Abstract.....	E-8
Table Of Contents.....	E-8
List Of Figures .....	E-8
Methodology For Determining Feasibility Of Lifting The EHIME MARU.....	E-9

## List of figures

Figure 1 – Light Weight Distribution .....	E-10
Figure 2 – Port Side View .....	E-11
Figure 3– Starboard Side View.....	E-11
Figure 4 – Port Side AFT.....	E-11
Figure 5 – Starboard Side Forward .....	E-11
Figure 6 – Port Side Forward .....	E-12
Figure 7 – Port Side Forward.....	E-12
Figure 8 – Mid Ship Section .....	E-12
Figure 9 – Station 7.5 (Frame 68) Section.....	E-13



### Methodology for determining feasibility of lifting the EHIME MARU

To safely lift the F/V EHIME MARU three areas of data were collected. First, the ship characteristics were taken from shipbuilders drawings:

IMO number	9142291
Length overall:	58.18 meters
Length between perpendiculars	50.00 meters
Beam:	9.30 meters
Draft:	3.50 meters
Depth:	3.90 meters
Light ship wt:	754 MT
Gross tonnage:	499 MT

Then oceanographic data on the prevailing sea and wind conditions in the area were obtained. This was followed by a detailed survey of the vessel as it sets on the bottom which was conducted using the NAVAL SEA SYSTEMS COMMAND Remotely Operated Vehicle DEEP DRONE.

Based on the data review, the following analyses were conducted:

1. Seakeeping capability of the SMIT PIONEER or a vessel with similar characteristics was reviewed and determined to be adequate to perform the salvage of the EHIME MARU. Historical wave data was obtained for the immediate salvage recovery area. It was also determined that the seas would be from the East Northeast direction. Wave direction and size, the heading of the EHIME MARU and the relative position of the salvage vessel to the EHIME MARU were reviewed for their impact on determining if satisfactory conditions exist for the critical initial lift. It was determined that the required wave conditions exist 35 percent of the time to perform the first critical part of the lifting operation.
2. From the wave data, SMIT TAK conducted a dynamic analysis which led them to a specific choice of lifting and rigging equipment and sea state limitations to be imposed. An independent analysis of the dynamic loading was conducted, which gave similar results to those of SMIT TAK. The dynamic analysis used an 8 second modal period for the motion of the stern of the lifting vessel (based on the motion of the SMIT Pioneer or similar type craft) and 4 parts of wire rope (115 mm nominal diameter by 600 m long, IWRC, modulus of elasticity of 105,000 N/mm<sup>2</sup>, cross-sectional metallic area of 6,275 mm<sup>2</sup>) attached to two slings (steel plates). The spring constant for each segment of the lift

system (i.e., each of the 4 lift wires) is 1,098,000N/m. The fundamental frequency response is on the order of about 1 Hz ensuring that the loading on the lifting vessel and the EHIME MARU would remain in phase. The dynamic simulation shows that the expected loading phase lag is minimal. The dynamic part of the loading on the rigging is dominated by inertial loading (+/- 906,100 N on each wire) with a minor viscous loading (+/- 30,550 N on each wire) 90 degrees out of phase with the inertial loading. The static part of the loading (light ship) on each of the lift wires is 1,849,000 N. With a minimum breaking strength of 7,884,000 N the maximum load of 2,755,100 N is well within the working load of the lift wires (35% of break strength). As a check of SMIT's proposed lifting sea state conditions (maximum wave height of 2 m) a simulation with the wave height doubled (4 m) resulted in acceptable levels of stress (45% of break strength) in the rigging. Computer simulations of the dynamic loading of the EHIME MARU and SMIT PIONEER are being run. The results of these simulations may require an increase in the size of the lift wire to maintain sufficient safety factor. These simulations will be run for each salvage platform that is considered for the operation.

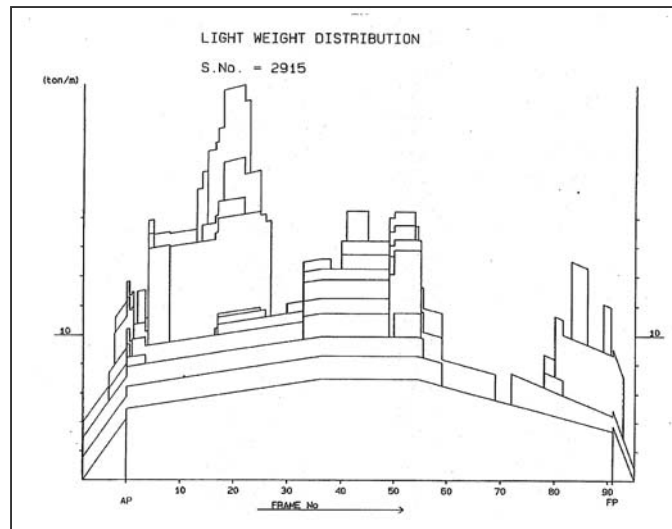

Figure 1. Light Ship Weight Distribution.

3. A light ship weight distribution was obtained from the shipbuilder as shown in Figure 1. The distribution was provided upon request by New Kurushima Dock Co.Ltd., the ship's designer.
4. From underwater surveys of the vessel, visible damaged areas on the hull of the ship were plotted. The survey was conducted by ROV with a videotape record for later reference. Without internal surveys, external damage was assumed to represent tripped structure internally. Thus, total reduction of the section modulus for hull scantlings in way of the damage was assumed as a "worst case". The damaged areas are shown in Figures 2-7.





Figure 6. Port Side Forward.

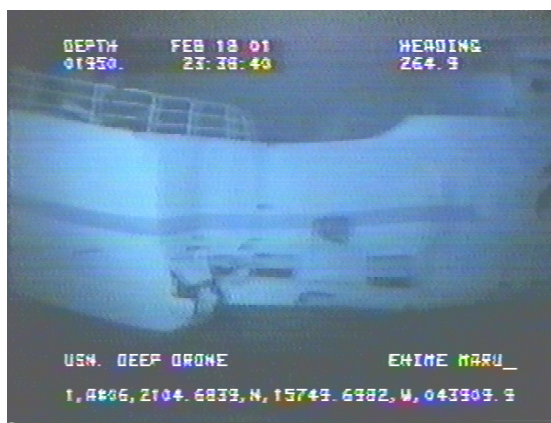

Figure 7. Port Side Forward.

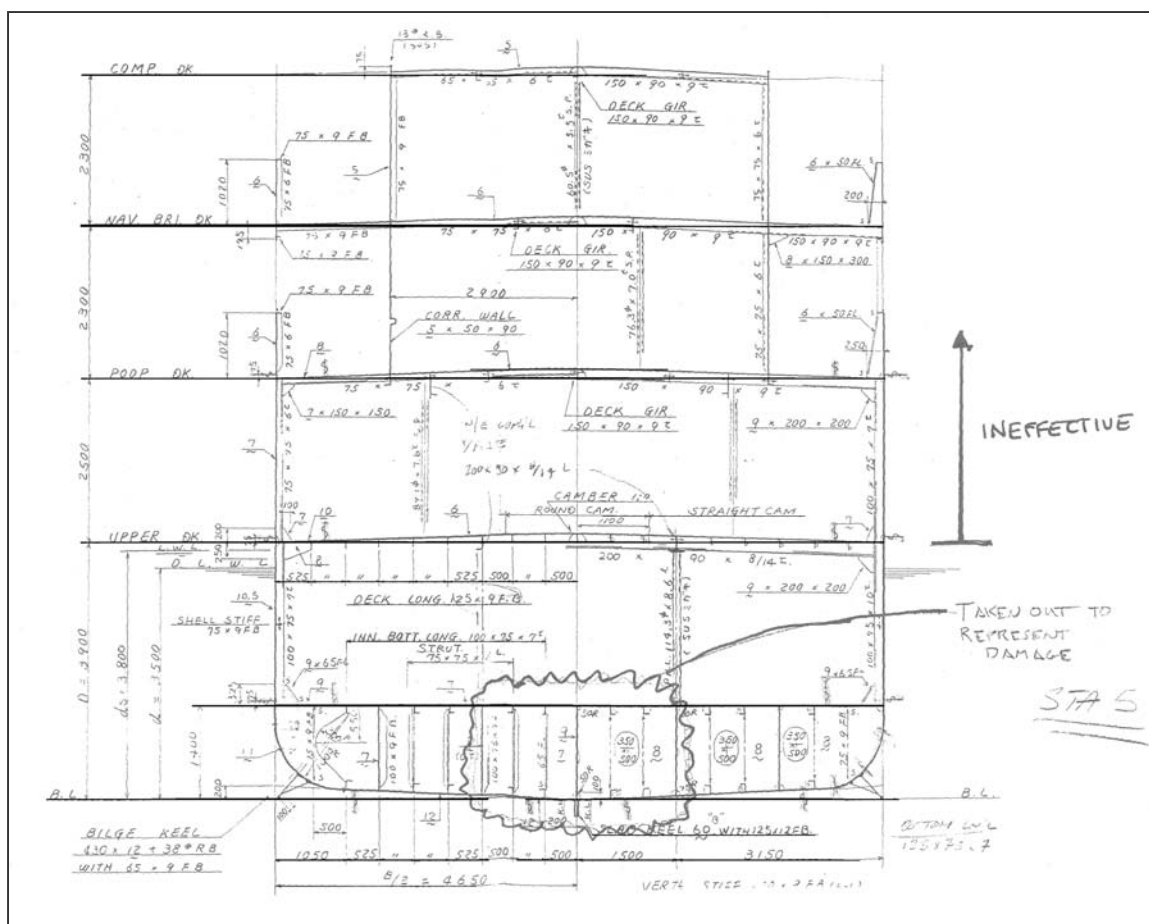

Figure 8. Station 4/5 (Midship) Section.

- The hull of the ship was modeled using beam type finite elements with the typical model having at least 200 nodes. Section properties for ten stations were determined using

structural drawings provided by the shipyard. Stations 0 through 5 include the poop deck while stations 6 through 10 only go to the upper deck. The house on the poop deck and its deck, the navigation bridge deck, were not included. Steel bulkheads within the ship were not included. For longitudinal strength calculations, all structures above the upper deck were considered ineffective. Damage to the bottom of the ship at stations 4 and 5 was modeled by removing the center girder, the side girders at 1500mm off centerline and the bottom and inner bottom in that region. Stations 4 and 5 are represented in figure 8. Damage at frame station 7.5 (Frame 68) was modeled by only counting the center girder, the side girders at 1500mm off centerline and the bottom and inner bottom in that region as shown in Figure 9.

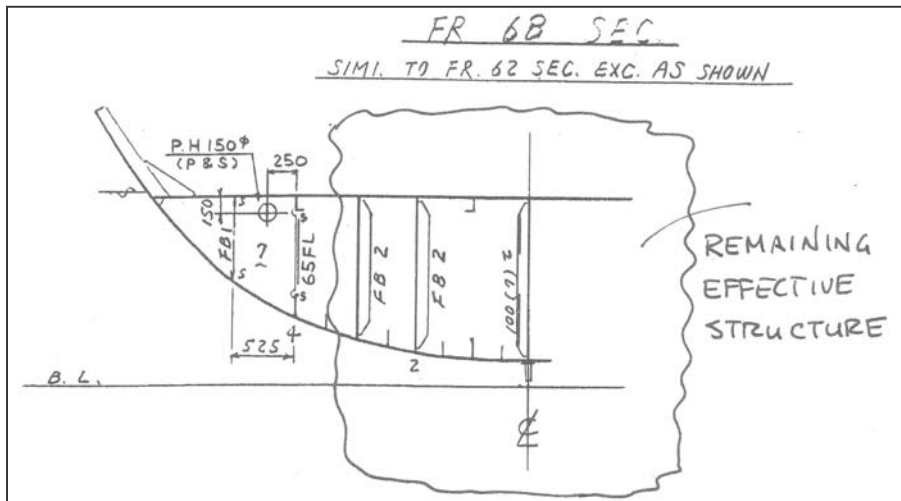

Figure 9. Station 7.5 (Frame 68) Section.

- Multiple scenarios positioning lifting plates at various locations were analyzed to assess the sensitivity of the bending moments to placement of the plates with respect to the damaged areas. Ultimately, lifting with two 1.25 m width plates (or multiple wire slings with an equivalent bearing area) placed at frames 15 and 61 combined with excavation of the sand under the bow was chosen as the best method. Stress levels aft for a two-point lift are not of concern however tensile stress in way of the forward damaged section will approach the yield capacity of the steel. This assumes a "worst case" loss of section modulus around frame 65. Excavation of the sand from under the bow will determine if a means of securing the bow section is required prior to conducting a two-point lift.

An alternative method for placing the plates under the hull at frames 15 and 61 would be to use a wire sling placed under the stern just above the rudder post, which is accessible to an ROV. Lifting the stern will place relatively high compressive loads on the poop

## **F/V EHIME MARU Recovery and Relocation Report**

deck but it is anticipated that the upper deck in this area will be able to carry the additional load.

7. Final engineering analysis will be performed before the lift ship is selected. This analysis will include the static and dynamic loading of the lifting gear as well as the lift ship deck structure. In addition, the effect on the EHIME MARU of the dynamic loads will be re-evaluated.

# Environmental Protection Plan for EHIME MARU Salvage

## Table of Contents

I.	Background.....	E-15
II.	Overview.....	E-17
III.	Deep Water Rigging Phase.....	E-18
IV.	Lift and Relocation Phase.....	E-18
V.	Shallow Water Operations Phase (Option A).....	E-18
VI.	Shallow Water Operations Phase (Option B).....	E-20
VII.	Disposal Phase (Option A).....	E-20
VIII.	Disposal Phase (Option B).....	E-20
IX.	Oil Removal from Submerged Vessel.....	E-20
X.	Oil Containment Boom.....	E-21
XI.	Preparations for Spill Response Operations.....	E-22
XII.	Response Equipment Descriptions.....	E-23

## I. Background

The Navy will go to extraordinary measures to protect the environment from the release of oil from the EHIME MARU during proposed salvage operations. These measures are appropriate given the high environmental and economic sensitivity of Hawaiian waters and shorelines, the high level of press and public interest in the EHIME MARU tragedy, and the unusually long lead-time allowed for planning the potential spill response. Having said this, the Navy anticipates relatively minor, “nuisance” oil spill levels with minimal environmental impact during vessel salvage operations, despite preparing for the worst-case event.

Although further research into EHIME MARU’s fuel and lube oils is in order, it appears that the fuel is relatively “non-persistent” oil that is expected to evaporate and naturally disperse more rapidly than heavier fuel oils, and that a low volume of the more persistent lube oil was on board at the time of the collision. The fuel oil is relatively toxic however and significant releases must be recovered or dispersed before they impact the sensitive resources in Hawaii’s near shore waters.

It is impossible to accurately predict the volumes of fuel and lubricants remaining on the vessel at this time, or the volumes that might be released during the various phases of the salvage operation. Nor will it be practical to so determine at any phase during the operation, short of “tapping” in at the tops of the tanks and removing remaining oil to the extent feasible. Such a removal would involve an increased risk of the release of oil to the environment and will be addressed further in Section IX - Oil Removal from Submerged

Vessel. It is likely that most or all of the fuel tanks are freely communicating with the sea and with the vessel's internal compartments through open tank vents and due to collision damage and the crushing effects of water pressure on partially filled tanks as the vessel rapidly plunged 600 meters to the sea floor.

The volume of air/vapor in the tanks was reduced by a factor of about 60 as the vessel rapidly descended. The type and condition of EHIME MARU's fuel tank venting system is not known at this time, but it is considered unlikely that it would have kept up with the rapidly changing pressure, and the tank walls were likely crushed, opening seams at the weakest points. The attitude of the vessel on the bottom (and in the water column during the lift), and the locations of open tank seams and/or vents, as well as the effects of current and surge will determine the volumes of oil remaining. A tank opening near the high point of that tank (including a functional vent) will allow most of the buoyant oil to escape, but damage low in a tank with a non-functional vent may allow only relatively minor release due to current-induced turbulence.

The salvage plan will seek to minimize the release of oil during salvage operations. The relative risks of release during the various salvage phases are addressed below, but generally speaking, the risk of a significant oil release is considered minimal. It is likely that most of the oil that is likely to escape has escaped at depth in the open water, where it was quickly diluted and resulted in minimal environmental impact. Unfortunately, raising the vessel, transporting it to shallow water, and even subsequent diving operations with the vessel resting on the bottom in shallow water will likely result in continued "sheening" as very small volumes of residual oil are released from the vessel and rise to the sea surface. Never the less, the Navy will be prepared to respond to a worst case spill event with state of the art mechanical and dispersant capability. But the reality is that, especially at the shallow water location, sheening, while environmentally insignificant, will be highly visible from the air and we may not be able to eliminate it entirely with booms, skimmers, and dispersants. The Navy will work with the Coast Guard Captain of the Port, the state of Hawaii, and other federal, state, and local government trustees to amend this environmental protection plan in any way practical to minimize environmental impact during salvage.



## II. Overview - Response Phases, Spill Risks, and Standby Spill Response Capability

For purposes of environmental protection, the following salvage phases will be addressed:

- Deep Water Rigging
- Lift and Relocation
- Shallow Water Operations
- Disposal

Preparation and stand-by of spill response assets will be commensurate with the risk anticipated during the various phases of the salvage operation. The proposed standby spill response capability for each salvage phase is summarized in Table 1 below, and is presented in greater detail in subsequent sections of text as outlined in the Table of Contents above. Equipment descriptions follow the text describing phases and response standby. The issues of potential oil removal from EHIME MARU while submerged, and the use of moored oil containment boom are addressed as noted in the Table of Contents above.

**Table 1: Response Phases, Spill Risks, and Standby Spill Response Capability.**

Phase	Risk	Spill Response Capability
Deep Rigging	Low	Periodic surveillance overflights 1 Vessel-mounted dispersant spray system on site 2 Skimmer Systems ready standby at Pearl Harbor 2 Helicopter Dispersant Buckets ready standby in Honolulu Full logistic support & standby relief crews
Lift & Relocate	Moderate	Frequent surveillance overflights 1 Vessel-mounted dispersant spray system on site 1 Skimmer System fully operational standby on site 2 <sup>nd</sup> skimmer system standby at Pearl Harbor & meet vessel @ 3 miles 2 Helicopter dispersant bucket systems ready standby in Honolulu Full logistic support & standby relief crews
Shallow Water Ops (Option A)	Low	Periodic surveillance overflights 1 Vessel-mounted dispersant spray system on site 1 Skimmer system standby on site initially and retained as required 2 <sup>nd</sup> Skimmer system ready standby at Pearl Harbor 2 Helicopter dispersant bucket systems ready standby in Honolulu Full logistic support & standby relief crews
Shallow Water Ops (Option B)	High	Surveillance overflight during lift 1 Vessel-mounted dispersant spray system on site 2 Skimmer System fully operational on site during lift 2 Helicopter dispersant bucket systems ready standby in Honolulu Consider additional options (e.g. two tow boats with wide sweep boom) Full logistic support & standby relief crews
Disposal (Option A)	Low	Periodic surveillance overflights 1 Skimmer system accompany vessel to 10 miles offshore 2 <sup>nd</sup> Skimmer system ready standby at Pearl Harbor 2 Helicopter dispersant bucket systems ready standby in Honolulu Full logistic support & standby relief crews
Disposal (Option B)	None	Not required

### **III. Deep Water Rigging Phase**

The risk of oil release from the EHIME MARU as a result of deep water rigging is considered minimal except to the extent that the vessel may be partially rigged and lifted or moved to facilitate further positioning of lift gear. If the vessel is lifted or moved during the rigging phase, spill response assets will be mobilized as for the lift and relocation phase addressed below. Otherwise, spill response assets will remain at their normal shoreside staging sites during deep water rigging.

### **IV. Lift and Relocation Phase**

The risk of oil release during the lift and relocation phase is considered moderate. If residual oil remains on the vessel, it is likely that some will be released as the vessel is disturbed and lifted through the water column and early in the transit to the shallow water site, but the release in deep, offshore waters should have minimal environmental impact. Oil released deep in the water column may never reach the surface or may be difficult to locate on the surface in all but flat calm conditions. Because the oil may surface some distance from the salvage vessel, and because the extent of the slick will be difficult to determine from the sea surface, a helicopter or fixed wing aircraft with experienced oil spotter personnel will be mobilized for frequent overflights during the lift and relocation phase of the salvage operation. In addition, one Navy vessel skimmer system (see description and photographs below) will be on standby at the lift site to recover spilled oil, with a second, fully operational system in standby at the SUPSALV Pearl Harbor Emergency Ship Salvage Material (ESSM) base. The second skimmer system will be mobilized to be on-scene when the EHIME MARU approaches within three miles of shore, or earlier as required. The environmental risk is increased in shallow water but the risk of an additional or continued release during the lift and relocation phase should diminish as the vessel approaches shallow water. In addition to the skimmer systems, two helicopter dispersant bucket systems with an adequate supply of dispersant (type and quantity to be determined) will be in standby ashore during the lift and relocation phase. Mechanical recovery of spilled oil is the preferred option, but dispersant application (in accordance with the Regional and Area Contingency Plans and “pre-approval guidelines”) is proposed to augment mechanical recovery as required.

### **V. Shallow Water Operations Phase (Option A)**

There are presently two options to meet the salvage objective of EHIME MARU crewmember recovery. Recovery option A involves diver search and recovery of crewmembers with the vessel resting on the bottom at the shallow water site. Following recovery, the vessel would be again lifted under the salvage vessel for transit to a deep-water disposal site. Recovery option B involves lifting the EHIME MARU onto a deck barge at the shallow water site, transit to a protected waters work site, and subsequent search and recovery of crewmembers in the dry environment. At this point, remaining environmental

pollutants would presumably be removed prior to ultimate disposition of the vessel. Option A involves a low risk of oil release in shallow water and disposal of EHIME MARU at a deep water site offshore with whatever environmental pollutants remain on board. Option B involves a high risk of release of remaining oil previously trapped by buoyant forces as EHIME MARU is lifted from the water at the shallow water, near shore site.

A possible amendment to either option A or B would be using divers to rig for oil removal from EHIME MARU's fuel and lube oil tanks with the vessel submerged at the shallow water site. This option is not recommended because of the difficulty and diver safety aspects of rigging the awkward "hot tapping" or other offloading equipment on or inside the vessel's hull, the fact that some of the oil will be trapped by internal tank framing and therefore inaccessible for removal, and the increased probability of release of oil to the environment during the offloading process.

For the low-risk, option A shallow water operations, the Navy would initially mobilize one fully operational Navy skimmer system to the spill site, with the second skimmer system and the two helicopter dispersant bucket systems in ready standby at Pearl Harbor and Honolulu staging sites, respectively. Frequent overflights would be continued during the diving operations, especially if ongoing operations indicate a higher likelihood of oil release. With the concurrence of the FOSC or the Unified Command, the Navy would demobilize the on-site skimmer to standby ashore status after a few days unless continued minor oil release dictates on-scene standby and/or recovery operations.

The environmental impact of a spill is generally greater in shallow, near-shore waters than at offshore, deep-water sites; but in this case the designation "shallow water" is relative. This site is not likely to be in less than 80 feet of water and will be exposed to open water current and sea state conditions. The closer proximity to sensitive near shore resources is a concern, but the immediate environmental impact of released oil here should be minimal compared with true shallow water depths (of a few feet or less). Both mechanical recovery and dispersant operations should remain viable options here (assuming required approvals for dispersant application), but the urgency of response will be greater closer to shore. Any oil not immediately recovered by one or both skimmers close to the source would be immediately dispersed by one or both dispersant bucket systems as required. There would be ample water volume and mixing energy for natural or enhanced dispersion and dilution of released oil. Again here, mechanical recovery is the preferred option, but dispersants would be applied without hesitation to prevent released oil from reaching and impacting sensitive shallow water, inter-tidal and shoreline areas. Dispersants would become the primary spill response option for shallow water operations if on-scene sea state conditions preclude safe mechanical recovery operations. The anticipated one or two day lift and relocation phase of the salvage operation will be initiated only if projected weather and sea state conditions are favorable for salvage and mechanical oil recovery. The shallow water operations phase will be of longer duration and favorable weather throughout will be less certain.

## **VI. Shallow Water Operations Phase (Option B)**

Option B operations are described above. Due to the uncertain volume of oil remaining on EHIME MARU at this point, the high risk of the release of remaining oil, and the proximity to environmentally and economically sensitive nearshore resources, spill response assets must be at optimum readiness during the proposed lift of EHIME MARU from the water. The surveillance aircraft would be overhead, both skimmer systems would be fully operational on-site, and both dispersant bucket systems with dedicated helicopters would be in ready standby ashore. Additional response systems will be considered in future planning if Option B appears likely.

## **VII. Disposal Phase (Option A)**

The Option A disposal plan of again slinging EHIME MARU under the salvage vessel and transiting to a deep, offshore disposal site would involve low risk to the environment at both the shallow water operations site and the deep-water disposal site. A spill response standby similar to the lift and relocation phase would be undertaken. The surveillance aircraft would conduct an initial and subsequent overflights as required during the transit to the disposal site. It would remain overhead at the disposal site long enough following release of EHIME MARU to support dispersant operations (as a spotter aircraft) or to determine that no significant oil was to be released. One skimmer system would escort the vessel to a location 12 miles offshore and return to base. The dispersant bucket systems would remain in standby for rapid response until ordered to stand down following successful vessel disposal.

## **VIII. Disposal Phase (Option B)**

The ultimate disposition of the EHIME MARU under the Option B scenario (lifting EHIME MARU onto a deck barge) has not been determined, but it is assumed that following crewmember recovery all pollutants would be removed prior to final disposition. If this were the case, further measures to protect the environment from the release oil or other pollutants would not be required.

## **IX. Oil Removal from Submerged Vessel**

Removal of fuel and lube oils from EHIME MARU during the various phases of the proposed salvage operation has been considered and will be retained as an option. At this time, it is considered a reasonable option only at the shallow water site, and only if option B (lifting EHIME MARU onto a deck barge) is implemented. At this time, it is considered that lifting EHIME MARU from the water is the only proposed shallow water operation involving greater risk of oil release than oil offloading from the submerged vessel.

Offloading EHIME MARU oil at the deep-water site is not considered a viable option at this time. Remotely Operated Vehicles (ROVs) designed and outfitted for through-hull access to fuel tanks are currently limited to 300-meter depths, and are not a fully reliable option in any case. In addition, depending on the condition and integrity of the tanks and tank vents, it is likely that tank access from inside the hull would be required, particularly for the lube oil tanks, in order to remove as much remaining oil as possible. Oil released from damaged tanks and trapped in other vessel spaces would be neither detectable nor accessible. Even proper access to tanks containing oil would not ensure complete oil removal as oil trapped by buoyant forces against the tanks internal strength members would not flow to the tank access point.

Setting the vessel down at an intermediate depth offshore for oil offloading using the specially equipped ROVs and/or saturation divers would be technically feasible, but would not resolve all the issues addressed above for the deep water site. Even a successful operation would not remove all remaining oil. Also, assuming a suitable intermediate depth site could be located, setting the vessel down before reaching the shallow water site could result in further structural damage to the vessel or fouling of the lift rigging jeopardizing or delaying the success of the shallow water crew member recovery. The ultimate duration, weather window considerations, and cost of the overall recovery operation would be dramatically impacted by an intermediate stop for offloading oil. And, for safety reasons, the Navy would not allow divers to attempt rigging for oil offload with EHIME MARU suspended below the lift ship at any phase of the operation.

At the shallow water site, offloading oil from the submerged vessel following appropriate rigging by divers, would be time consuming but feasible. Even here, it is unlikely that all remaining oil would be removed. And as noted above, it is considered that oil offloading at the shallow water site would be more likely to result in significant release of oil than the option A submerged lift and return to a deep water disposal site. Therefore, it is proposed that the shallow water oil removal option would be implemented only prior to an option B lift onto a deck barge, or if for an unforeseen reason, a significant ongoing release of oil were to occur at the shallow water site that could not be controlled by other means.

## **X. Oil Containment Boom**

The use of oil containment boom to encircle a potential, sea surface, spill source is often standard operating procedure in shallow, inshore, protected water locations. The use of containment boom offshore has appeal in theory but is generally not applicable. In the case of the EHIME MARU, containment boom will be impractical except when used in conjunction with the Navy's offshore skimmer systems to sweep an area and funnel floating oil to the skimmer. Even at the shallow water operations site (where mooring containment boom would be difficult but feasible), variable currents would make it impossible to predict with sufficient accuracy where released oil would surface, in order to position and moor the containment boom system. In addition, moored boom has limited effectiveness containing

oil in an open-water environment, it would interfere with vessels supporting ongoing diving operations, and the large 1,000 lbs anchors and heavy chain moorings could damage coral or other sensitive elements of the sea bottom ecosystem. The use of highly mobile, towed boom systems, to direct oil to integral skimmer systems, is a more effective offshore mechanical response option. Such boom/skimmer systems are positioned down wind or down current from the spill source and their movements are directed by surveillance/spotter aircraft overhead, to maximize oil recovery.

## **XI. Preparations for Spill Response Operations**

The following are presented as areas requiring further planning and preparation if the decision is made to proceed with EHIME MARU salvage operations:

- Determine specifications of fuel and lube oils and other potential pollutants on EHIME MARU. This will dictate selection of appropriate dispersant and skimmer belts.
- Run deep water oil dispersion model to determine likely fate of fuel released at depth
- On-water and aerial surveys of deep and shallow water salvage sites to validate plans
- Ensure appropriate command and control arrangements between salvage and spill response operations and Incident Command System / Unified Command (ICS/UC) requirements of Federal and State On-Scene Coordinators
- Address response equipment manning and training issues, including relief crews for prolonged on-water operations.
- Detailed dispersant planning:
  - Coordinate detailed dispersant planning with USCG Federal On-Scene Coordinator and other appropriate Hawaii area authorities, trustees, response specialists, etc. Determine pre-approval zones and other applicable requirements.
  - Determine and purchase appropriate type and quantity of dispersant for EHIME MARU fuel and lube oils.
  - Validate selection of helicopter spray buckets as appropriate dispersant application resource, versus vessel spray bars, fire monitors, etc.
  - Select / mobilize application equipment & operators (including application and spotter aircraft, and communications)
  - Determine expertise and training levels of selected dispersant application team. Conduct air crew and ground crew training trials as required
  - Develop plans and safety guidelines, including separation zones, for conducting dispersant operations in the vicinity of ongoing salvage and mechanical oil recovery operations, as well as shorelines. Work with USCG to establish security zones as required.

## XII. Response Equipment Descriptions

### SUPSALV Offshore Skimmer System:

The SUPSALV Offshore Skimmer System consists a 36 feet long, Marco Class V vessel skimmer with a 3 feet wide sorbent lifting belt. The skimmer has a USCG rated daily recovery capacity of 1371 barrels. The skimmer is towed in a “V-configuration” through a floating oil slick, behind a pair of tow boats with 300 feet legs of oil containment boom funneling oil to the skimmer belt as indicated in the photographs below. The skimmer has a 1200-gallon on-board sump, but also tows a 26,000-gallon floating oil storage bladder for extended offshore operations.



**Navy SUPSALV Offshore Skimmer System** – Note forward end of oil storage bladder in left foreground, skimmer vessel in center with oil containment “V-booms” forward of the skimmer all towed by a pair of towing vessels



**SUPSALV Offshore Skimmer System** – Aerial View and view showing Skimmer System in Oil

### **Dispersant Application Equipment:**

The most appropriate type and quantity of dispersant and application equipment are yet to be determined. Preliminary indications are that a pair of dispersant spray buckets like the one in the photograph below are available through the local oil spill cooperative, “Clean Islands Council”. Navy or local commercial, or possibly Coast Guard helicopters and/or small fixed wing aircraft will be considered as dispersant application platforms and as general surveillance aircraft or spotter aircraft for dispersant and/or mechanical recovery operations.



**Helicopter Dispersant Bucket System**



# Plan for Recovery of the Remains of Crewmembers from the Japanese Fishing Vessel EHIME MARU

4740  
Ser 00C/0021  
13 APR 2001

From: Commander, Naval Sea System Command  
To: Commander in Chief, U.S. Pacific Fleet

Subj: PLAN FOR RECOVERY OF THE REMAINS OF CREWMEMBERS FROM  
THE JAPANESE FISHING VESSEL EHIME MARU

Ref: (a) Feasibility Report 00C Ser 0017 of 21 March 2001

Encl: (1) Plan for Raising Fishing Vessel Ehime Maru to Allow Recovery of  
Crewmembers

1. Enclosure (1) provides a description of the plan for raising Ehime Maru from the depth of 600 meters off the coast of Oahu to recover the remains of any crewmembers that may be trapped in the vessel. With the dual goals of recovering the remains of crewmembers and limiting impact on the environment, the method chosen uses a team of divers to conduct the actual recovery without lifting the vessel through the surface. This will eliminate the excessive stresses that lifting the vessel clear of the water would place on the damaged hull of Ehime Maru. It will also limit any adverse environmental impact as any fuel or oil currently trapped by hydrostatic pressure will not be released as would occur if the vessel were lifted clear of the water.

2. In the initial feasibility study provided by reference (a), engineering calculations were based on a Deep-Sea Support Vessel with a specific list of critical parameters. Vessel availability to support lifting and moving Ehime Maru to shallow water during the best possible weather window will require that specific calculations be accomplished for any vessel selected.

3. This report focuses on the method for recovery of victims. Environmental remediation is addressed during each phase, if applicable. However, Phase I, conducting an environmental assessment, is not specifically addressed in this report.

B. MARSH  
Supervisor of Salvage and Diving  
Director of Ocean Engineering, USN

# Plan for Raising Fishing Vessel EHIME MARU to Allow Recovery of Crewmembers

13 April 2001

Prepared by:  
Naval Sea Systems Command,  
Supervisor of Salvage and Diving (SEA 00C)

## Table of Contents

### Introduction

Tasking.....	E-27
Statement of Condition of Vessel on Bottom .....	E-27
Impact of Damage on Options .....	E-28
Options Considered Based on the Damage to the Hull.....	E-30
Method Selected .....	E-30

### Discussion of Plan

Phase II - Mobilize Salvage Forces.....	E-31
Phase III - Rigging w/ ROV .....	E-33
Phase IV - Deep Water Lift and Transit to 30m Dive Site.....	E-35
Phase V – Post-lift ROV Survey.....	E-37
Phase VI - Crewmember Recovery .....	E-38
Phase VII – Preparation and Disposal of EHIME MARU at Deep Water Site. ...	E-40

**Introduction**

**Tasking.** The fishing vessel Ehime Maru sank in 600 meters, following a collision with USS GREENEVILLE (SSN 772). At the time of the sinking, all but nine of the crewmembers were successfully rescued. Following an extensive air/sea search, and a subsea search and visual inspection of the vessel’s exterior, it is assumed that some, or all, of the missing crew became trapped inside the vessel. Commander in Chief, U.S. Pacific Fleet requested that Naval Sea Systems Command (NAVSEA), locate the vessel and provide a plan for recovering the missing crewmembers.

**Statement of Condition of Vessel on Bottom.** The Deep Submergence Unit Remotely Operated Vehicle (ROV) located Ehime Maru on 9 February at 157° 49’ West Longitude and 21° 05’ North Latitude. The vessel is sitting upright on the bottom but has obvious hull damage. Detailed salvage surveys were conducted by NAVSEA and Deep Submergence Unit ROVs, producing in excess of 20 hours of videotape. A pair of salvage masters from Smit Tak, a salvage contractor from Rotterdam, and a Japanese team of salvage experts viewed Ehime Maru via the video feed from the ROVs. The ship characteristics taken from the shipbuilder’s drawings are as follows:

Ship’s Characteristics	
IMO Number	9142281
Length Overall	58.18 Meters
Length Between Perpendiculars	50 Meters
Beam	9.30 Meters
Draft	3.50 Meters
Depth	3.90 Meters
Light Ship Weight	754 Metric Tons
Gross Tonnage	499 Metric Tons

Given the 600-meter depth of the Ehime Maru, its light ship weight and damaged condition, this will be a precedent setting operation, as characterized in Figure 1.

Damage that is evident from the video survey is highlighted in Figures 2, 3, and 4. The most obvious damage (shown in the pictures in Figures 3 and 4) is seen in the forward port and starboard shell plating in way of frame 68. Here the plating has visible buckling presumably from the impact of the vessel when it hit bottom. Other obvious damage includes bending of the forward mast to port and minor shell plate buckling at the stern and bow. She sits with her stern buried up to two meters in the sandy bottom with her rudder and screw not visible.

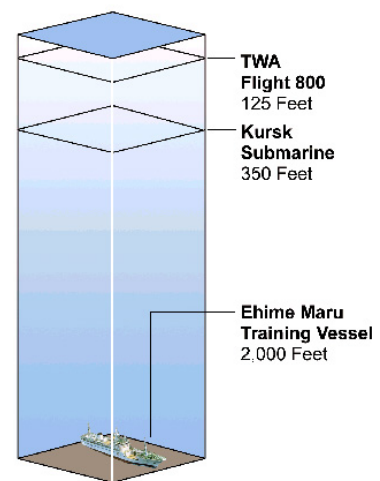

**Figure 1. Depth Comparison.**



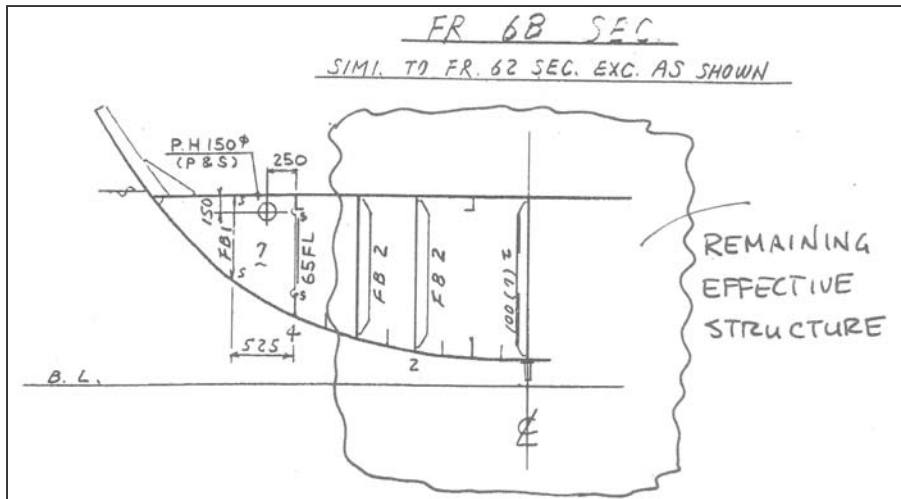
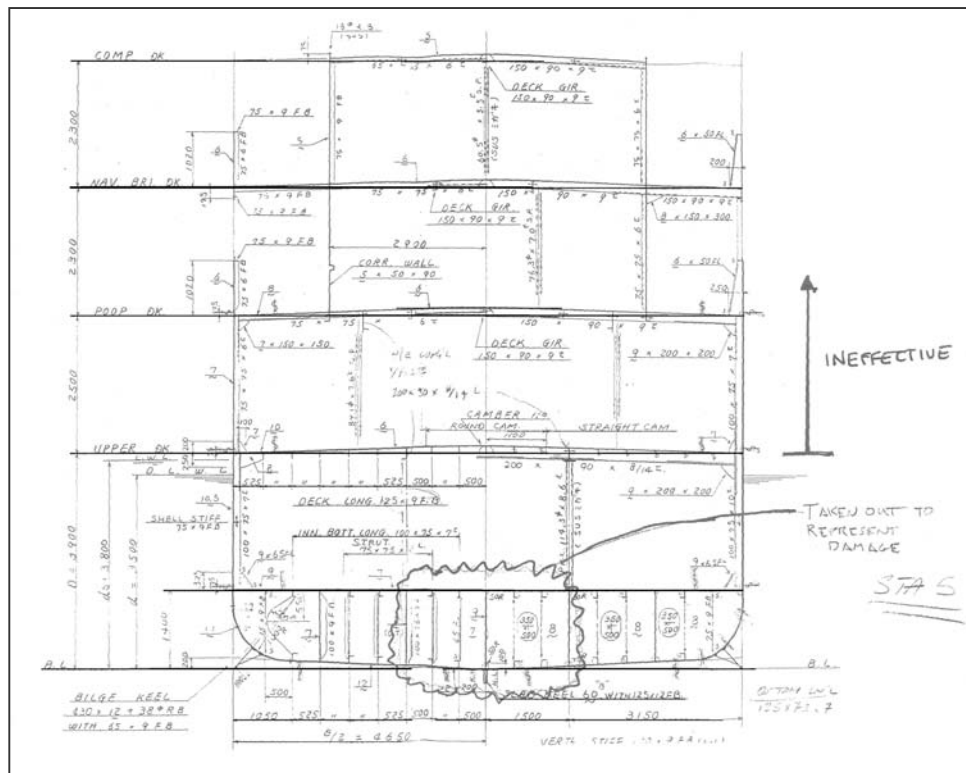

Figure 5. Cross Section at Frame 68.



For the aft damage adjacent to frame 18 the center girder, side girders up to 1500mm from centerline and bottom and inner bottom were assumed to be damaged and unable to carry any load. Figure 6 describes the section. Note that poop deck and navigational decks are excluded as load bearing structure.

Using multiple bending moment scenarios, compressive and tensile stresses on the hull were calculated to assess the likelihood of structural failure of the hull during lifting.

Localized panel buckling was also considered. At frame 68, where the visible hull damage is most prominent, calculated bending stresses approach yield for the static load imposed in dead lifting the vessel from the bottom. From the static analysis and concurrent dynamic analysis conducted on proposed lift configurations with typical Multi-Purpose Support Vessel sea keeping response profiles, a direct lift to the surface and up onto an ocean-going barge was deemed to be an unacceptable risk.

***Options Considered Based on the Damage to the Hull.*** The first option considered for recovering remains of crewmembers was the use of a mini-ROV to enter the hull and search for and recover crewmembers. Once the vessel was located and found to be intact but with damage to internal bulkheads, this option was deemed not feasible. This type of operation has two problems: first, a precision method of cutting to provide access at that depth does not currently exist and second, fouling of the ROV's umbilical inside Ehime Maru is a major drawback. Without clear definition of where to locate remains, a full search of all compartments would be necessary. Based on the damage visible to the exterior hull and projecting damage to the stern based on the penetration of USS GREENEVILLE's rudder, it is reasonable to assume that bulkheads and piping on the interior also suffered damage. This would increase the likelihood that a mini-ROV would become fouled and unable to accomplish a recovery.

An alternative method for conducting an internal search of the hull would be to use saturation divers. However, at 600m this is not a viable option. Though open ocean dives have been accomplished at this depth, the extensive work of recovering crewmember remains would be not be possible.

***Method Selected.*** To safely recover crewmember remains, the only feasible approach is to rig Ehime Maru on the bottom with lifting straps, lift her off the bottom, and transit to a shallow site. There the vessel can be laid down on the bottom and divers can conduct a thorough survey of all compartments. This method eliminates the adverse affects of lifting the vessel out of the water and maintains Ehime Maru close to the bottom during transit. Rigging for the lift will be accomplished using ROVs, which limits use of typical eductor type tunneling equipment. From multiple bending moment calculations, use of a pair of straps lifting at frames 15 and 61 provides the necessary support and allows effective balancing of the load. Placement of the straps presents a challenge as up to two meters of the hull is buried in the sandy bottom.

Two alternatives are being investigated to position the straps. First would be using a directional drilling technique to tunnel under the vessel passing steel plate straps. This would eliminate the need to stress the hull by lifting to place the straps underneath. Should directional drilling not prove effective, a second method is passing a wire under the stern aft

of the rudderpost as the vessel currently sets. Lifting from this aft position enough to pass the straps would set up a bending moment, placing compressive stresses on the poop and navigational decks that may buckle these non-strength members. However, the upper deck and side shell will be able to accept the load.

## Discussion of Plan

***Phase II - Mobilize Salvage Forces.*** Mobilization of salvage forces includes the acquisition, charter, rent, and manufacture of all equipment necessary to support the operation. This mobilization is driven by the requirement to complete the lift and relocate Ehime Maru to the near-shore site at a 30m depth by the end of August to optimize weather conditions. The major equipment required to perform the salvage operation includes:

- Coiled tube drilling system
- Remotely Operated Vehicles (2)
- WASP One Atmosphere Suit
- Special equipment design and fabrication including sheaves, clumps, spreader assembly, lifting frame, and general salvage support hardware
- Anchor handling tug
- Linear winches
- Lifting wire
- Multi-purpose support vessel
- Ocean going barge with tug for supporting diver operations and disposal.

The overall timeline for mobilization is shown in Figure 7, leading to the relocation of Ehime Maru by 15 September. Commitment for the floating assets is critical; specifically the ROCKWATER 2 (RW2), which is a Halliburton owned ship. As shown, the long lead systems include the coiled tube drilling system and the engineering, fabrication, and procurement of salvage systems. Both of these systems have been started via contract with Smit-Tak and will be completed in 70 days in Houston in order to meet the required shipment date for transport to Hawaii. Equipment will be ready for shipment in mid-June. The shipment to Hawaii will take 22 days so that all equipment will be staged in Hawaii in mid-July to commence outfitting of the RW2. Specific discussions of the equipment is included in the Phase III and IV sections of this report.

Mobilization of the linear winches and two lengths of 115mm wire rope will commence in Rotterdam in late May and will take 40 days for shipment to Hawaii. The winches and wire will be available for installation on RW2 in mid-July.

The ROVs and WASP are currently located in Houston and will be mobilized for shipment to Hawaii onboard the anchor handling tug in mid-June for arrival in Hawaii in mid-July.

## F/V EHIME MARU Recovery and Relocation Report

Mobilization of an anchor handling tug will start in mid-June in Houston. The tug will be loaded with the coiled tube drilling system, salvage support equipment, ROVs, and WASP. She will depart Houston in mid-June for arrival in Hawaii in mid-July.

Mobilization of the RW2 will commence on 20 June in the Philippines. Transit time to Hawaii will take 20 days so that she will be available in Hawaii for outfitting in mid-July. The outfitting of RW2 with all salvage support equipment is scheduled for 14 days. The ship will be fully outfitted and ready to commence the salvage operation by 01 August.

Additional assets and equipment are required for supporting the divers during the crewmember recovery phase, the fuel offloading phase, and the disposal phase. NAVSEA has contracted Crowley Marine to provide support for these phases. This support will consist of an ocean going barge with ballast lift capability, tug, and support equipment. Crowley will mobilize the barge and tug from the West Coast of the U.S. in mid-August and commence outfitting of diving support and lift support equipment in late August. Crowley will provide support equipment including mooring systems, crane, power, accommodations, and hotel services. The diving equipment will be provided by Mobile Diving and Salvage Unit One (MDSU ONE). The barge and tug will support the crewmember recovery operations until completion, currently scheduled for mid-October. At the completion of the crewmember recovery, Crowley will support the MDSU divers in the fuel offloading using hot tap systems and other means. This phase is estimated to be complete in seven days.

The final phase will be deep-sea disposal of Ehime Maru. Crowley's barge and tug will be configured to perform a ballast lift of Ehime Maru two meters off the bottom and transport to a selected deep-water site. Ehime Maru will be sunk at that final site. Estimated time for this phase is seven days.

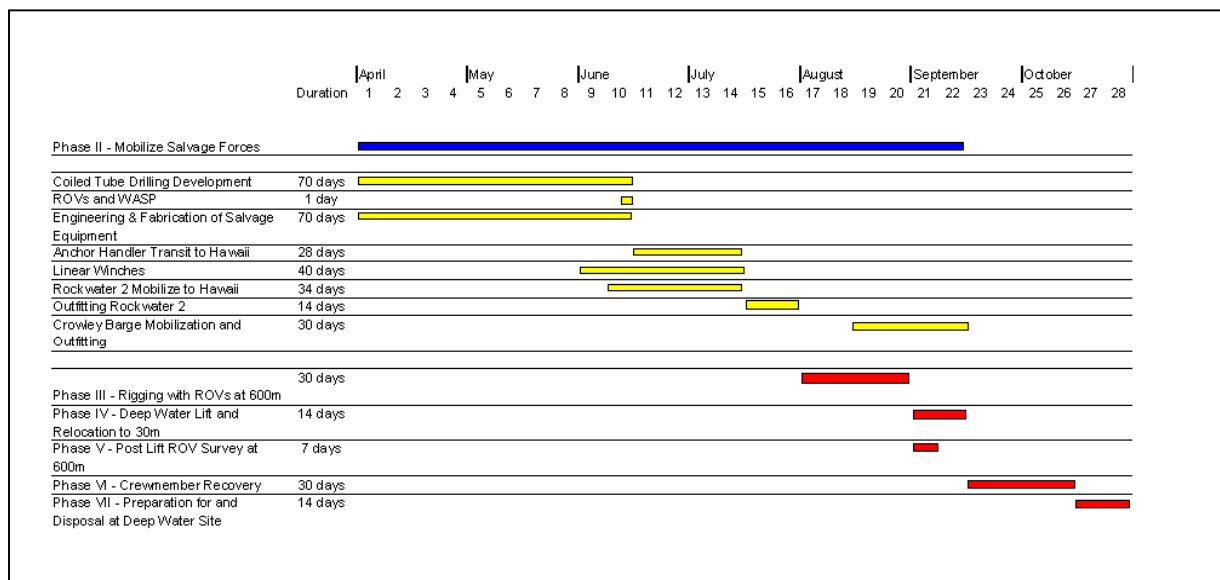

Figure 7. Mobilization Timeline.



**Phase III - Rigging w/ROV.** This phase of the operation will include preparation of Ehime Maru for lifting from 600m depth. The operation will utilize two floating assets for accomplishment; the RW2 and an anchor-handling tug. The RW2 is a multi-purpose support vessel with dynamic positioning capability, heave compensated crane, and other assets necessary for performance of the operation. She will be outfitted with special drilling equipment, linear traction winches, lifting wire, two Remotely Operated Vehicles, a WASP One Atmosphere Diving Suit, and all fabricated hardware for the operation. The rigging will be performed in several sequential steps as follows:

- a. **Inspection of Ehime Maru by ROV** – A thorough inspection of Ehime Maru will be performed by one of the ROVs to finalize details for the rigging. During this inspection, a number of tests and trials will be performed including scouring out the area beneath the bow of Ehime Maru.
- b. **Removal of Debris** – The ROVs will be used to remove and recover any debris attached to or around Ehime Maru including fishing nets, lines, rafts, and rigging on the masts.
- c. **Placement of Lifting Plates and Aligning Clumps** – The RW2 salvage crew will place various equipment on the seafloor adjacent to Ehime Maru in preparation for installation of the lifting plates (Figure 8). The lifting plates are 14m x 1.25m x 11mm with bridle terminations on each end. This will be accomplished using the heave compensated crane and a long baseline precision navigation system.

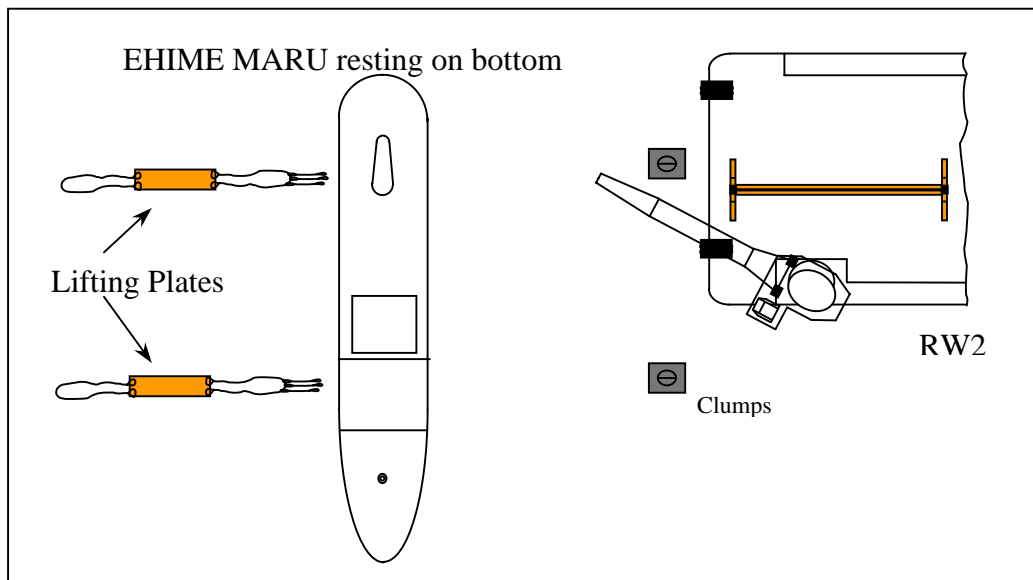

Figure 8. Positioning the Lifting Plates and Clump Weights on the Seabed.

- d. **Coiled Tube Drilling** – The coiled tube drilling system will be utilized to drill beneath the hull of EHIME MARU. The system developed in Houston is shown schematically in Figure 9. The figure shows the system supported from the surface with the actual drilling system on deck. An alternate system with the drilling head positioned on the bottom is also being considered. Final system selection will be made within the first month of the development process. As shown on the figure, a hole (approximately 350mm) will be drilled beneath EHIME MARU using the directional capability of the system. Additional holes may be drilled parallel to the original hole depending on the testing that will be performed in Houston prior to mobilization. The process will be repeated for both forward and aft lifting plate locations.

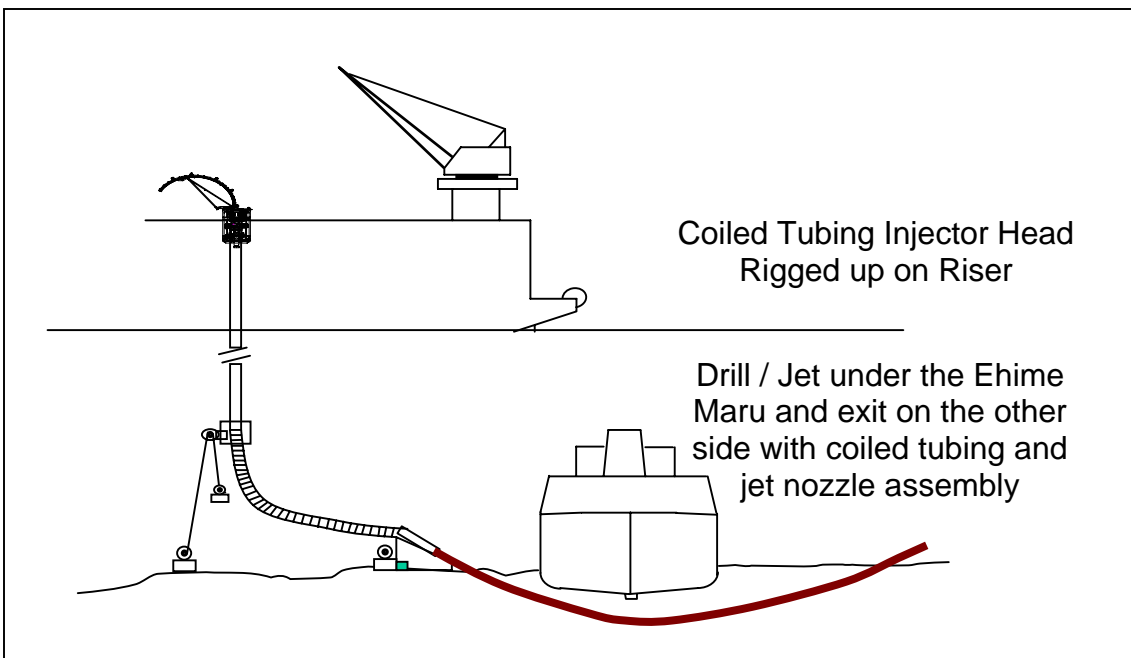

Figure 9. Coil Tube Drilling System.

- e. **Lifting Plate Installation** – After the holes are drilled beneath Ehime Maru, messenger lines will be utilized to attach to the ends of the lifting plates. High strength wire ropes will be attached to the lifting plates through the drilled holes and reaved around sheaves on the clumps. A water jetting assembly will be attached to the end of the lifting plate to assist in the extrusion of the plate through the sediment beneath Ehime Maru. The plates will be pulled through the drilled holes using either the ship's heave compensated crane or the anchor handling tug. A contingency plan has been developed in case the drilling operation is not successful. That alternate plan includes lifting the stern of Ehime Maru by the RW2 to gain access to pull the lifting plates under the hull. Access to the stern area is available to pass a sling. This method requires lifting the stern about four degrees allowing access for installation of the two lifting plates.

- f. **Installation of Spreader Assembly** – The final step in the rigging process is to install the spreader assembly, see Figure 10. The spreader assembly is positively buoyant by 20 tons and held down by clumps configured below the assembly and outboard of Ehime Maru suspended from brackets. The assembly will be lowered with the heave compensated crane and positioned over Ehime Maru at a pre-determined location. When properly positioned, the two lifting plates will be attached to the spreader assembly using messenger lines from the RW2. ROVs will be used extensively during all activities in this phase. Figure 10 shows the spreader assembly positioned above Ehime Maru and the ends of the lifting plates in the process of being attached to the spreader. Once the lifting plates are attached, Ehime Maru is fully rigged and ready to be lifted. The RW2 will then recover any rigging material left on the bottom.

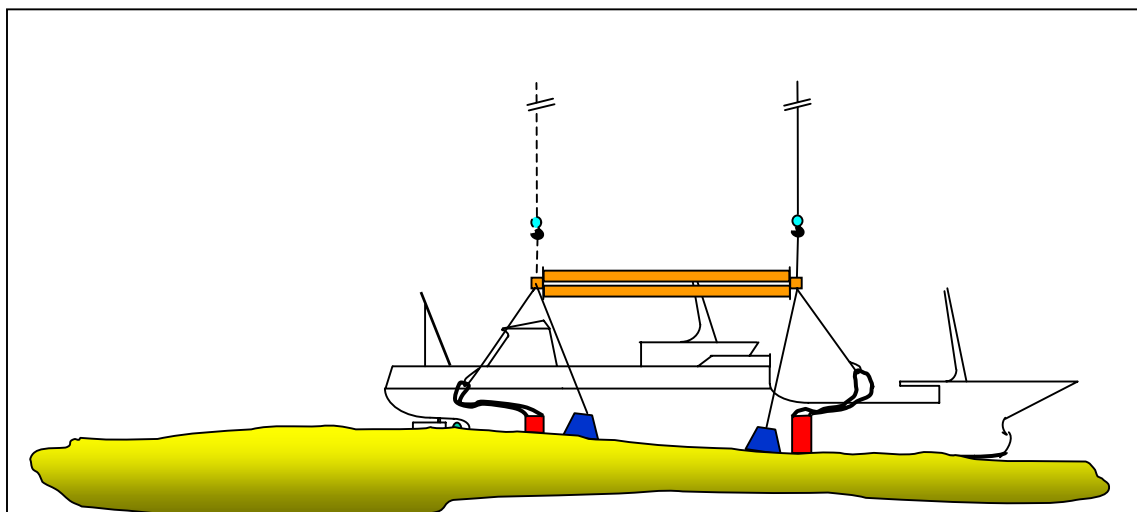

Figure 10. Pulling the Slings into the Spreader Beam.

*Phase IV - Deep Water Lift and Transit to 30m Dive Site.* This phase of the operation will include development of a bathymetric map of the seafloor along the route to be taken; making the initial lift of Ehime Maru from the seafloor; inspecting the vessel while suspended approximately 20m to 30m above the seafloor; transit to the 30m dive site and placing the hull on the bottom for the diver survey. Throughout each of the following steps of this phase, one of the ROVs will be deployed to monitor the condition of the hull and lifting rig (see Figure 11).

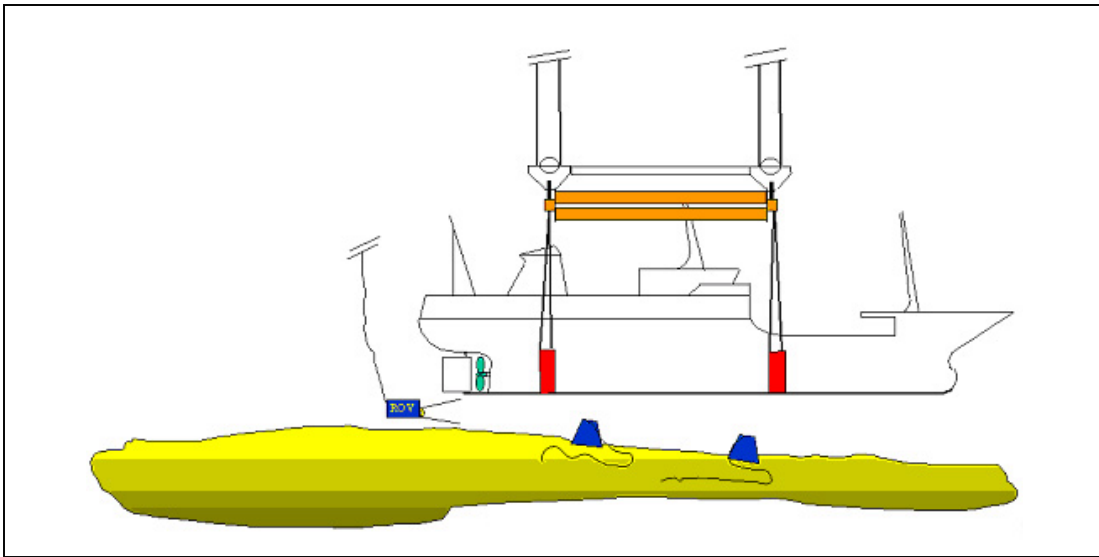

Figure 11. Transit to 30m Dive Site.

- a. **Bathymetric Survey.** Prior to conducting the lift the routes between the salvage site, the diver inspection site and the final disposal site will be surveyed utilizing a precision fathometer coupled to a differential global positioning system or military GPS navigation system. This information will enable the RW2 to safely transit along the route with Ehime Maru suspended between five and fifteen meters above the seafloor.
- b. **Diver Survey of the 30m Site.** At the 30m dive site, USN divers will conduct a thorough survey of the site and ensure that the bottom conditions will facilitate setting the hull down in a stable, upright position. They will also survey the anchor drop points for the moor that will be deployed to support the dive platform. Video documentation of the bottom will be made during each of the dives.
- c. **Sea Restrictions During the Lift and Transit.** To ensure that the lift and transit is accomplished safely, a computer simulation with the RW2 and the proposed rigging material was done with wave heights up to four meters. To preclude any damage to Ehime Maru, transit will only be conducted if the forecast wave height is two meters or less.
- d. **Lift Timing.** The lift will not commence until a 72-hour window of favorable weather is predicted. The salvage team will utilize USN weather services throughout the operation.
- e. **Transit to 30m Site.** During transit to the 30m dive site one of the ROVs will be deployed to monitor the condition of Ehime Maru and the rigging gear. The ROV

will utilize its sonar to ensure that Ehime Maru is maintained between 20m and 30m off the seafloor, and does not impact any outcrops, rocks or cliffs. The transit speed will not exceed one knot.

- f. **Remediation during Lift, Transit and Placement at 30m Site.** Because oil might be released from the vessel during the lift or transit, a helicopter or fixed wing aircraft will be utilized to monitor for evidence of a release. A surface skimming system will be deployed with RW2 and an additional system will be on standby in Pearl Harbor. Subject to approval, two oil dispersant systems will be provided that can be deployed by helicopter. As RW2 approaches the 30m dive site, the second surface skimmer system will deploy to augment the initial system. Both skimmer systems will standby while Ehime Maru is placed on the bottom at the 30m site. Periodic over flights will continue to monitor for evidence of oil or fuel coming to the surface.
- g. **Bottom Stability of Ehime Maru at 30m Site.** When Ehime Maru is placed on the bottom at the 30m site, an ROV will conduct a thorough survey of Ehime Maru to ensure that her hull rests solidly on the seafloor. To ensure diver safety, no dives will be attempted until the vessel has remained in a stable position for 24 hours. At that time, an external diver survey will be completed and the divers will assist RW2 in detaching from the spreader assembly. The lifting bar will be recovered, leaving the spreader assembly suspended over Ehime Maru. RW2 will then commence demobilization. After the vessel has remained stable for 48 hours, the internal diving will commence. At any time that the vessel shifts, or otherwise exhibits any indication of instability, diving operations will cease until stability is re-established.

**Phase V – Post-lift ROV Survey.** As soon as practically possible following the lift of Ehime Maru, a visual survey of the sea floor where the vessel originally laid will be conducted. The purpose of the survey will be to ensure that all items of interest have been collected from the site. The survey will be accomplished with SUPSALV's ROV, DEEP DRONE.

The survey will cover a search grid of approximately 1000 meters by 1000 meters and will be centered on the area where Ehime Maru originally sat. The survey will consist of parallel and overlapping search runs with the entire grid being visually inspected. The visual survey will be limited to the 1000-meter square box unless the inspection warrants expanding the grid. This is deemed reasonable since a thorough visual and side scan sonar search outside of this box was conducted during the initial search and recovery effort. A video tape will be made of the entire search for documentation purposes.

The recovery of any remaining personal effects will be accomplished with the ROV manipulators and a collection basket. Recovered items will be placed in the basket and subsequently brought to the surface utilizing the ROV's drop hook. All personal effects will then be inventoried, washed with fresh water, bagged, and immediately turned over to the Japanese Consulate. In addition to the recovery of personal effects, any remaining items that pose a future danger (i.e., fishing nets, hooks, etc.) will also be recovered.

The Government of Japan (GOJ) has expressed an interest in possibly providing a Japanese owned and operated ROV for the post-lift inspection. If the GOJ does pursue this option and depending on the capabilities of the ROV utilized, then use of a USN asset may not be necessary.

***Phase VI - Crewmember Recovery.*** U.S. Navy diving personnel will be augmented by SRF Yokosuka Japanese Divers. The SRF Yokosuka Japanese divers are already under OPNAV waiver to use U.S. Military diving equipment on a U.S. Navy dive station. Four SRF Yokosuka Japanese divers will be requested to support the mission, allowing two per shift. While one Japanese diver is in the water, the other will be at the communications console. Other than diving, they will be able to identify spaces through the diver's camera topside monitor. These divers will be a major part of the salvage through diving and topside support. They will not count as part of the minimum dive team requirements since they will be performing other duties when not diving.

Per the *U.S. Navy Diving Manual*, a minimum of eight divers is required to operate a surface-supplied diving side using more than one diver. This operation will require two diving systems in use for a minimum of 16 divers per shift. This does not include the personnel required for decontamination, chamber surface-decompression, stage handling, topside camera systems, winch operators, medical personnel, etc.

The estimated 30 meters of water will put divers on a Surface Decompression Table using Oxygen between 30m to 35m depending on actual depth at final rest. Some dives will be less than 30 meters when divers are working in upper decks. Based on this, divers will have between 60 and 90 minutes of bottom time with less than 15 minutes of in-water decompression. With quick turn around times, the maximum amount of dives possible in a 12-hour shift is six. Using three divers per dive, this would require 18 divers per shift. The intention is to use two shifts to support 24-hour diving operations.

## Discussion of Methodology of Entering, Inspecting and Documenting all Compartments

***Entering.*** The third deck is the deepest deck on the Ehime Maru. This deck has the engine room, student mess room, refrigerator storeroom, etc. Three divers will be used when entering this third deck. Red diver will enter the second deck through passageways accessible on the first deck and will be tended until he is at the ladder or opening to the third deck. Green diver will proceed into the second deck to meet up with Red diver while being tended by Yellow diver. Red diver will then proceed to the third deck while being tended by Green diver. Yellow diver will tend Green diver.

***Inspecting, Recovering, and Documenting.*** The initial inspection will be conducted on last known location of the sailors. Remains and personnel affects encountered will be collected and removed to the surface. If all remains are not recovered during this search, an extensive search of every space will be conducted and documented on video tape. The entry to each space will be clearly marked and numbered. The diver will enter the space and perform a thorough search of the entire space. The helmet mounted camera and light system will be connected to a topside video recorder and monitor. The Diving Supervisor, the SRF Japanese diver, as well as Japanese VIPs can observe the entire search topside through this monitor. The ship's drawing topside will be marked as the divers complete each inspection. A space is completely searched when topside personnel are satisfied that there are no remains in that space. Operations will continue until all victims have been found or all spaces have been thoroughly searched with video documentation.

***Details of Support Platform to be Used.*** NAVSEA will contract with Crowley Marine for the diving support barge CMC 450-10. This barge will be used as a dive platform during the recovery phase and then used as the lift platform for at-sea disposal. The 120 meter long by 30 meter wide barge has power, water, galley, mooring gear, cranes, and berthing for 80 personnel. The barge will be outfitted with mortuary facilities and appropriate personnel to handle crewmember remains. The barge will be moored and supported with the assistance of a commercial tug contracted by NAVSEA.

***Type of Diving Used With Number of Chambers Required.*** Surface Decompression using Oxygen will be used for decompressing the divers. This will allow for minimum time spent in the water with the majority of decompression conducted topside in a recompression chamber under a controlled atmosphere. Two chambers will be used for the operation. A Transportable Recompression Chamber System (TRCS) will be used for the Surface Decompression and a Fly Away Diving System (FADS) Dixie Double Lock chamber will be used for treatment of Arterial Gas Embolism (AGE) or Decompression Sickness (DCS).

***Remediation Effort During Crewmember Recovery Phase.*** During the crewmember recovery phase, NAVSEA will provide personnel and equipment to ensure that the environment is protected by performing periodic surveillance over flights. Additionally, we will maintain one vessel-mounted dispersant spray system on site. One skimmer system will be located on site for the initial survey period and retained as required. A second skimmer system will be in ready standby at Pearl Harbor. Two helicopter dispersant bucket systems will be retained in ready standby in Honolulu.

***Timeline.*** The planned duration for the recovery phase is 30 days. This phase includes load out, mooring, bad weather days, and a full stem-to-stern inspection and video documentation. The length of this phase can be reduced if all crewmembers are found early. As mentioned in Phase IV, diving operations will not start inside the hull until 48 hours after returning Ehime Maru to the ocean floor. This initial time will be utilized to perform external inspections of the condition of the vessel.

***Phase VII – Preparation and Disposal of Ehime Maru at Deep Water Site.*** Once the dive team completes operations, Ehime Maru will be lifted back off the seafloor and taken to a deep-water disposal site. The barge that supported the diving operations will be utilized to make the lift and take Ehime Maru to her final resting place. Steps in this phase include:

- a. **Preparation for Disposal.** The initial task in this phase is to remove the fuel and lube oil from Ehime Maru to prepare for ocean disposal. Depending on the condition and integrity of the tanks and tank vents, it is likely that tank access from inside the hull would be required, particularly for the lube oil tanks, in order to remove as much remaining oil as possible. Oil released from damaged tanks and trapped in other vessel spaces would be difficult to detect and recover. Even proper access to tanks containing oil would not ensure complete oil removal, as oil trapped by buoyant forces against the tanks internal strength members would not flow to the tank access point. Offloading oil from the submerged vessel following appropriate rigging by divers is feasible, however, it is unlikely that all remaining oil would be removed. A method for offloading oil would utilize divers to access tanks through vents and pumping to the support barge. Alternately, a hot tap system can be used to access tanks through tank tops and sides to increase accessibility. A detailed plan will be developed for oil removal during the planning and engineering phases of the operation. However, based on the condition of the tanks and piping on Ehime Maru, it may be prudent not to attempt fuel removal as it may increase the risk of environmental damage at the near shore site.



**b. Method for Reattachment.**

The barge will ballast down approximately 4.5 meters while moored directly over EM. The lifting beam will be lowered back to the spreader assembly, this time utilizing 100mm, Grade 3 chain instead of wire rope. Divers will attach the lifting beam to the spreader assembly and do a final inspection to insure that all rigging is still in place. See Figure 12.

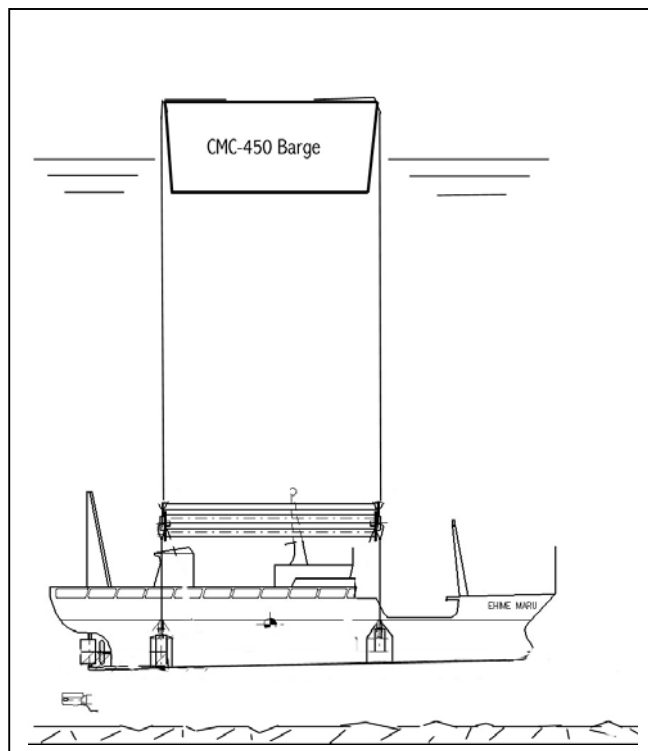

**Figure 12. Barge Lift and Transit to Disposal Site.**

**c. Lift from Sea Floor.**

Once divers are clear of the water and conditions are acceptable, the slack will be taken out of the lifting chains using deck winches and wire rope. Once all slack is out of the chains, the barge will be deballasted to return to its original draft. This will lift Ehime Maru clear of the sea floor for transit to deep water.

**d. Transit to the Disposal Site.**

Two tugs will be used to tow the barge/ Ehime Maru to the disposal site, following the surveyed route. One tug will tow, while the other is connected to the stern of the barge to maintain constant drag for control. A maximum speed of one knot will be maintained.

**e. Sinking at the Disposal Site.**

Navy divers will flood the spreader assembly and rig explosive cutters on the slings to release Ehime Maru from the lifting assembly. The barge will then be towed back to Pearl Harbor to demobilize the dive system and personnel, completing the operation. During this phase, NAVSEA will provide periodic surveillance over flights to detect any spill. A skimmer system be retained on site during the entire oil removal process and will accompany the vessel to ten miles offshore. A second skimmer system will be retained in ready standby at Pearl Harbor throughout the process. Two helicopter dispersant bucket systems will be in ready standby in Honolulu and full logistic support will be provided.

## CNO TASK

Following is the 142041Z FEB 01 date time message from the CNO to NAVSEA regarding tasking of NAVSEA 00C to provide equipment and personnel to support search and recovery operations of F/V EHIME MARU.

RUHPYNB T USS SALVOR  
P 142041Z FEB 01 PSN 584108M26  
FM CNO WASHINGTON DC//N31//  
TO RULSSEA/NAVSEASYS COM WASHINGTON DC//00C//  
INFO RUEKJCS/CJCS WASHINGTON DC//J3/J5/OSDP//  
RHHMUNA/USCINCPAC HONOLULU HI//J3/J4/J31//  
RHCUAAA/USCINTRANS SCOTT AFB IL  
RHHMHAA/CINCPACFLT PEARL HARBOR HI//N3/N4//  
RUHPQUA/COMTHIRDFLT  
RHHMDBA/COMSUBPAC PEARL HARBOR HI//N3//  
RUHEMDQ/COMNAVSURFGRU MIDPAC//00/01/N3//  
RUHEMCQ/COMNAVREG PEARL HARBOR HI//00//  
RUHPYNB/USS SALVOR  
BT  
UNCLAS  
MSGID/GENADMIN/N31//  
SUBJ/SALVAGE OPERATIONS//  
REF/A/ORDER/USCP/122217ZFEB2001//  
REF/B/ORDER/CPF/130241ZFEB2001//  
REF/C/ORDER/C3F/130253ZFEB2001//  
REF/D/PHONECON/CPF/142000ZFEB2001//  
PAGE 02 RUENAAA0777 UNCLAS  
NARR/REF A IS USCP EXORD/  
REF B IS CPF EXORD/  
REF C IS C3F EXORD/  
REF D IS PHONECON BETWEEN CNO N312 AND CPF N3. CPF REQUESTING  
NAVSEA SEARCH AND RECOVERY ASSETS//  
POC/STEVE GUNTHER/LT/OPNAV N312/-/TEL:703-614-1675//  
RMKS/1. WRT REFS A,B,C AND D, NAVSEA 00C COORDINATE WITH CPF AND C3F  
TO PROVIDE EQUIPMENT AND PERSONNEL TO SUPPORT SEARCH AND RECOVERY  
OPERATIONS OF F/V EHIME MARU. DIRLAUTH CPF. KEEP ALCON INFORMED.  
2. NAVSEA CAPTURE INCREMENTAL COSTS OF THIS OPERATION IAW DOD.  
FINANCIAL MANAGEMENT REGULATION 7000.14R, VOL12, CHAPTER 23. REPORT  
COSTS TO CNO FMB (POC: CDR HOOKS, DSN: 227-0973).//  
BT  
#0777  
NNNN

00C ....ACT FOR COMNAVSEASYS COM  
01P 04L3 04LR 04X2 05F 05M 05Y 91F 92Q 92T  
PMS392 PMS308 PMS325P PMS395 PMS470 411M

## TASK ORGANIZATION

This is an excerpt of a 151841Z JUN 01 date time group message from CINCPACFLT PEARL HARBOR to multiple parties regarding task organization as an addendum to the CINCPACFLT Planning Order.

HEADING/TASK ORGANIZATION//  
GENTEXT/SITUATION/

1. THE JAPANESE FISHING VESSEL EHIME MARU WAS STRUCK BY THE USS GREENEVILLE ON 09 FEB 01. THE VESSEL SANK IN APPROXIMATELY 2000 FEET OF WATER 10 NM SOUTH OF OAHU, HAWAII AT 21-04.8N, 157-49.5W. TWENTY-SIX CREWMEMBERS WERE RECOVERED AT THE TIME OF THE ACCIDENT. NINE CREWMEMBERS REMAIN UNLOCATED.//

GENTEXT/MISSION/

PAGE 04 RHHMHAA0237 UNCLAS

2. WHEN DIRECTED BY CINCPACFLT:

A. REQUEST NAVSEA PROVIDE RELOCATION, RECOVERY AND OIL SPILL RESPONSE SUPPORT.

B. COMTHIRDFLT PROVIDE DIVING OPERATIONS, SECURITY AND COMMUNICATIONS.

C. COMPACAREA COGARD, REQUEST ESTABLISHMENT OF SAFETY ZONES, PROVIDE AFLOAT SECURITY, MEDICAL EVACUATION ASSISTANCE, AND OIL SPILL MANAGEMENT TEAMMEMBERS.

D. COMNAVREG HAWAII PROVIDE LOGISTIC SUPPORT FOR DIVING OPERATIONS, SHORE SECURITY DURING OFFLOAD OPERATIONS, AFLOAT SECURITY AT SHALLOW WATER SITE (NAVAL DEFENSE SEA AREA), OILY WASTE TREATMENT SERVICES, OIL SPILL MANAGEMENT TEAM MEMBERS, TRANSFER OF FUEL OIL TO FUEL DEPOT, AND EMERGENCY MEDICAL SUPPORT.

E. NAVPACMETOCEN PEARL HARBOR HI REQUEST PROVIDE WEATHER FORECASTING SUPPORT.

F. FLTIMAGCOMPAC SAN DIEGO, PROVIDE COMBAT CAMERA (COMCAM) PERSONNEL TO DOCUMENT RELOCATION AND RECOVERY OPERATIONS FOR THE F/V EHIME MARU. SCOPE OF COVERAGE WILL BE DEFINED SEPCOR.

GENTEXT/EXECUTION/

3. COMMANDER'S INTENT.

PAGE 05 RHHMHAA0237 UNCLAS

A. PURPOSE. PREPARE A COMPREHENSIVE PLAN TO SUPPORT CREWMEMBER RECOVERY OPERATIONS FROM THE FISHING VESSEL EHIME MARU. IF UNLOCATED CREWMEMBERS ARE FOUND, PRIORITY OF EFFORT IS THE RECOVERY OF THE CREWMEMBERS.

B. METHOD. COMTHIRDFLT DEVELOP A PLAN TO PROVIDE SECURITY, COMMUNICATIONS, DIVING, OIL SPILL PREPAREDNESS AND RESPONSE AND OTHER SUPPORT AS REQUIRED BY CINCPACFLT DURING THE RECOVERY OF UNLOCATED CREWMEMBERS OF THE F/V EHIME MARU. PLAN WILL INCLUDE ESTIMATED FORCE REQUIREMENTS, TIMELINE, AND COST OF OPERATIONS. ALL STEPS SHOULD BE TAKEN TO MINIMIZE ENVIRONMENTAL IMPACT DURING THE RELOCATION AND RECOVERY OPERATIONS AS OUTLINED IN THE ENVIRONMENTAL ASSESSMENT PREVENTIVE MEASURES PLAN WHICH IS CURRENTLY UNDER DEVELOPMENT AND SCHEDULED TO BE SIGNED ON 14 JUN 01 WILL BE DISTRIBUTED SEPCOR. CINCPACFLT N43 IS PREPARING THE ENVIRONMENTAL ASSESSMENT AND WILL SUPERVISE THE PLANNING AND EXECUTION OF THE RECOVERY OPERATION. ALL PLANNING AND EXECUTION EFFORTS WILL BE COORDINATED THROUGH CINCPACFLT N43.

C. ENDSTATE. RECOVERY OF THE UNLOCATED CREWMEMBERS, PERSONAL EFFECTS, SHIP UNIQUE ITEMS AND POL TO THE MAXIMUM EXTENT

## F/V EHIME MARU Recovery and Relocation Report

PRACTICABLE, AND RELOCATION OF F/V EHIME MARU TO DEEP WATER.  
PAGE 06 RHHMHAA0237 UNCLAS

### 4. TASKS:

#### A. COMTHIRDFLT BE PREPARED TO:

- (1) DELEGATE ON-SCENE TASKING TO COMNAVSURFGRU MIDPAC. COMNAVSURFGRU MIDPAC WILL REPORT DAILY TO CINCPACFLT N43 FOR DIRECTION IN ALL PHASES OF THE EHIME MARU RELOCATION AND CREWMEMBER RECOVERY.
- (2) DEVELOP HEALTH AND SAFETY PLAN FOR OVERALL RECOVERY OPERATION. DESIGNATE OPERATIONAL SAFETY OFFICER TO COORDINATE ALL SAFETY PLANS FOR NAVY COMMANDS AND CONTRACTORS.
- (3) ESTABLISH COMMUNICATION PLAN TO INCLUDE VIDEO AND DIGITAL TRANSMISSION CAPABILITY.
- (4) DEVELOP MEDICAL EVACUATION PLAN FOR ALL PHASES OF THE RELOCATION AND RECOVERY PHASES.
- (5) PROVIDE AFLOAT AND ASHORE EMERGENCY MEDICAL SERVICES.
- (6) TRAIN JAPANESE DIVERS FROM NAVAL SHIP REPAIR FACILITY YOKOSUKA, JAPAN IN SUPPORT OF RECOVERY OPERATIONS.
- (7) CONDUCT EXTERNAL SURVEY 24 HOURS AFTER F/V EHIME MARU HAS BEEN RELOCATED IN THE SHALLOW WATER SITE.
- (8) INVESTIGATE METHODS TO REMOVE OR CONTAIN BAIT AND FISH STORED IN FREEZER/REEFER UNITS LOCATED WITHIN THE SHIP.

PAGE 07 RHHMHAA0237 UNCLAS

- (9) CONDUCT DIVING OPERATIONS FOR THE RECOVERY OF UNLOCATED CREWMEMBERS, PERSONAL EFFECTS, SHIP UNIQUE ITEMS AND PETROLEUM, OIL, AND LUBRICANTS (POL) TO THE MAXIMUM EXTENT PRACTICABLE.
- (10) DOCUMENT ALL ITEMS RECOVERED AND ESTABLISH CHAIN OF CUSTODY.
- (11) TRANSFER RECOVERED CREWMEMBERS REMAINS TO CHIEF MEDICAL EXAMINER, CITY OF HONOLULU.
- (12) CONDUCT HAZARDOUS MATERIAL REMOVAL OF THE F/V EHIME MARU WHERE FEASIBLE.
  - (A) REMOVE POL/HAZMAT TO THE MAXIMUM EXTENT PRACTICABLE.
  - (B) DISPOSE OF ANY REMOVED POL/HAZMAT IN ACCORDANCE WITH FEDERAL, STATE AND LOCAL LAWS/REGULATIONS.
- (13) REMOVE THE AFT MAST FROM EHIME MARU PRIOR TO THE RELOCATION TO DEEP WATER AS DIRECTED.

- (14) PROVIDE VIDEO DOCUMENTATION OF F/V EHIME MARU RECOVERY OPERATIONS AND ESTABLISH VIDEO CHAIN OF CUSTODY.
- (15) REMOVE/SECURE/CONTAIN ALL LOOSE TOPSIDE AND INTERNAL MATERIAL ON F/V EHIME MARU PRIOR TO DEEP WATER RELOCATION.
- (16) CONNECT EHIME MARU LIFTING HARDWARE FROM RELOCATION VESSEL.

PAGE 08 RHHMHAA0237 UNCLAS

- (17) UPON COMPLETION OF DIVING/RECOVERY OPERATIONS, CONDUCT UNDERWATER CLEAN UP AT THE SHALLOW WATER WORK SITE.
- (18) DOCUMENT ALL EVENTS AND PROVIDE FINAL REPORT TO CINCPACFLT N43 UPON COMPLETION OF CREWMEMBER RECOVERY AND FINAL VESSEL RELOCATION.
- (19) SUBMIT LESSONS LEARNED UPON COMPLETION OF CREWMEMBER RECOVERY AND VESSEL RELOCATION TO DEEP WATER.

#### B. NAVSEA 00C BE PREPARED TO:

- (1) DESIGN AND ENGINEER A PLAN TO RELOCATE F/V EHIME MARU FROM ITS CURRENT POSITION TO A DESIGNATED SHALLOW WATER WORK SITE FOR DIVING, RECOVERY AND REMEDIATION OPERATIONS.
- (2) PROVIDE ALL RESOURCES REQUIRED TO CONDUCT DEEP WATER RIGGING AND RELOCATION EFFORT.

- (3) RELOCATE THE F/V EHIME MARU FROM CURRENT DEEP WATER POSITION TO DESIGNATED SHALLOW WATER WORK SITE.
- (4) PROVIDE A SUPPORT PLATFORM CAPABLE OF SUPPORTING CREWMEMBER RECOVERY DIVE OPERATIONS AT THE DESIGNATED SHALLOW-WATER SITE.
- (5) PROVIDE TECHNICAL SUPPORT FOR CREW RECOVERY AND REMEDIATION ISSUES.
- (6) RELOCATE THE F/V EHIME MARU FROM THE DESIGNATED SHALLOW WATER R 151841Z JUN 01 ZYB PSN 493000M16  
UNCLAS

FINAL SECTION OF 02

SITE TO FINAL DESIGNATED DEEP-WATER SITE AT CONCLUSION OF RECOVERY/REMEDICATION OPERATIONS.

- (7) PROVIDE LOGISTIC SUPPORT, OIL SPILL RECOVERY EQUIPMENT AND OPERATORS, AND OIL SPILL MANAGEMENT TEAM MEMBERS AS REQUIRED.

- (8) DEVELOP POL RECOVERY PLAN.

C. COMNAVREG HAWAII BE PREPARED TO:

- (1) IMPLEMENT PLANNED OIL SPILL PREPAREDNESS MEASURES AS IDENTIFIED IN THE ENVIRONMENTAL ASSESSMENT.
- (2) ENSURE THE SERVICES OF CLEAN ISLANDS COUNCIL AND OTHER RESPONSE PREPAREDNESS CONTRACTORS ARE ESTABLISHED AND NOTIFY SMT MEMBERS PRIOR TO EXECUTING ANY EVOLUTION THAT HAS THE POTENTIAL TO RELEASE OIL. IF AN OIL RELEASE OCCURS AT ANY TIME DURING RELOCATION OR RECOVERY PHASES, IMPLEMENT ICS.
- (3) PROVIDE SHORE SECURITY ELEMENTS TO SUPPORT ANY POTENTIAL OFF-LOAD OPERATIONS, AS REQUIRED.

PAGE 04 RHHMHAA0238 UNCLAS

- (4) PROVIDE LOGISTICS SUPPORT, INCLUDING BUT NOT LIMITED TO HAZMAT AND ENVIRONMENTAL, AS REQUIRED.
- (5) PROVIDE WATERBORNE SECURITY AT SHALLOW WATER SITE (NAVAL SEA DEFENSE AREA) DURING RECOVERY/REMEDICATION OPERATIONS.
- (6) PROVIDE EMERGENCY MEDICAL SUPPORT SERVICES AS REQUIRED.
- (7) PROVIDE OILY WASTE COLLECTION AND TREATMENT SERVICES AND TRANSFER ANY RECOVERED FUEL OIL TO FISC PEARL HARBOR FUEL DEPOT OR OTHER APPROPRIATE STORAGE AND DISPOSAL CONTRACTOR AS REQUIRED.
- (8) PROVIDE FULLY TRAINED SPILL MANAGEMENT TEAM (SMT) TO INCLUDE ALL INCIDENT COMMAND SYSTEM (ICS) FUNCTIONS AND REQUIRED POSITION ASSIGNMENTS BELOW THE INCIDENT COMMANDER LEVEL.
- (9) SCHEDULE ICS TRAINING AND TABLE TOP EXERCISE FOR SMT MEMBERS.
- (10) DEVELOP SMT NOTIFICATION AND MOBILIZATION PLAN FOR SMT MEMBERS AND OUTSIDE AGENCIES TO SUPPORT THE VARIOUS PHASES OF RECOVERY OPERATION AND AS DESCRIBED IN THE ENVIRONMENTAL ASSESSMENT. PLAN SHALL INCLUDE COMMAND CENTERS TO BE USED (INCLUDING USE OF HAWAII OIL SPILL RESPONSE CENTER DURING LIFT AND RELOCATE PHASE) COMMUNICATIONS AND EQUIPMENT PLANNING TO SUPPORT FULLY FUNCTIONING OIL SPILL MANAGEMENT SHOULD UNANTICIPATED OIL RELEASE OCCUR AND UNIFIED COMMAND IS STOOD UP.

PAGE 05 RHHMHAA0238 UNCLAS

- (11) OBTAIN SERVICES AGREEMENT WITH CLEAN ISLANDS COUNCIL (CIC)(HAWAII) TO SUPPORT OIL SPILL PREPAREDNESS AND RESPONSE BASED ON RECOVERY PHASES.
- (12) COORDINATE ALL PUBLIC AFFAIRS MATTERS WITH CINCPACFLT PAO.
- (13) PROVIDE ASSISTANCE DURING TRANSFER OF RECOVERED CREWMEMBER REMAINS TO MEDICAL EXAMINER, CITY OF HONOLULU.

D. COMPACAREA COGARD TO:

- (1) ESTABLISH SAFETY ZONE AND PROVIDE AFLOAT SECURITY AT THE DEEP WATER SITE, DURING TRANSIT TO THE SHALLOW WATER SITE, DURING TRANSIT TO THE DEEP WATER RELOCATION SITE, AND DURING FINAL

## F/V EHIME MARU Recovery and Relocation Report

VESSEL PLACEMENT AT THE DEEP WATER SITE. COORDINATE WITH COMNAVSURFGRU MIDPAC TO ENSURE ALL SAFETY ZONE AND ENFORCEMENT OF SAFETY ZONES ARE ESTABLISHED.

(2) ASSIST IN THE DEVELOPMENT OF A MEDICAL EVACUATION PLAN FOR ALL PHASES OF THE RELOCATION AND RECOVERY.

(3) PROVIDE OIL SPILL MANAGEMENT TEAM MEMBERS AS REQUIRED INCLUDING FEDERAL ON-SCENE COODINATOR FOR UNIFIED COMMAND.

E. NAVPACMETOCCEN BE PREPARED TO:

(1) PROVIDE DAILY OPAREA SPECIFIC DETAILED FORECASTS IN SUPPORT OF RELOACTION AND RECOVERY OPERATIONS.

PAGE 06 RHHMHAA0238 UNCLAS

(2) ADVISE CINCPACFLT REGARDING THE ABILITY TO PROVIDE REAL TIME SURFACE CURRENT INFORMATION DURING RELOCATION OPERATIONS AND BE PREPARED TO PROVIDE REQUIRED INFORMATION IF DIRECTED.

(3) PROVIDE OIL SPILL MANAGEMENT TEAM MEMBERS AS REQUIRED.

F. FLTIMAGCOMPAC SAN DIEGO:

(1) COORDINATE WITH COMTHIRDFLT ON STILL AND VIDEO ACQUISITION AND DUPLICATION REQUIREMENTS. DEPLOY SUFFICIENT COMCAM PERSONNEL TO MEET TASKING.

(2) COORDINATE WITH COMNAVREG HAWAII ON PUBLIC AFFAIRS RELATED IMAGING REQUIREMENTS. DIRECT FLTIMAGCENPAC HAWAII TO MEET STILL IMAGING TASKER IN THE LOCAL OPAREA.

5. COORDINATING INSTRUCTIONS

A. C-DATE: 09 FEB 2001

B. LENGTH OF DEPLOYMENT: NOT TO GO BEYOND 15 NOV 2001.

C. ROE. STANDING CJCS ROE WITH USCINCPAC SUPPLEMENT IN EFFECT. REQUEST CHANGES IN ROE FROM CINCPACFLT.

D. CLASSIFICATION GUIDANCE. THIS OPERATION IS SENSITIVE BUT UNCLASSIFIED.

E. DIRLAUTH ALCON. KEEP CINCPACFLT N43 INFORMED.

F. OPSEC GUIDANCE. PLANNING FOR THIS OPERATION IS UNCLASSIFIED.

PAGE 07 RHHMHAA0238 UNCLAS

DUE TO HIGH PUBLIC INTEREST, MAXIMUM EFFORT WILL BE MADE TO PROVIDE UNCLASSIFIED INFORMATION RELATING TO ACTIVITIES AND EQUIPMENT INVOLVED IN THIS OPERATION.

GENTEXT/ADMIN AND LOG/

6. PUBLIC AFFAIRS GUIDANCE

A. THE PUBLIC AFFAIRS APPROACH TO THIS DEPLOYMENT IS ACTIVE.

CINCPACFLT PA HAS BEEN COORDINATING WITH ALL AGENCIES INVOLVED.

UNITS MUST COORDINATE ALL REQUESTS FROM THE MEDIA WITH CINCPACFLT PUBLIC AFFAIRS REP FOR THIS OPERATION, MR. JON YOSHISHIGE, (808) 471-3769, DSN 315 471-3769. EMAIL YOSHISJ@CPF.NAVY.MIL.//

7. FUNDING. PROVIDING COMMANDS WILL FUND ALL COSTS OF OPERATIONS/DEPLOYMENT/REDEPLOYMENT. INCREMENTAL CONTINGENCY COSTS WILL BE REPORTED VIA YOUR ADMINISTRATIVE FUNDING CHAIN OF COMMAND.// GENTEXT/COMMAND AND SIGNAL/

8. COMMUNICATIONS. USE ORGANIC COMMUNICATIONS. VIDEO AND DIGITAL TRANSMISSION IS REQUIRED. IF ADDITIONAL COMMUNICATIONS IS REQUIRED, SUBMIT REQUEST TO CINCPACFLT.

9. COMMAND RELATIONSHIPS. USCINCPAC IS THE SUPPORTED CINC.

CINCPACFLT IS THE SUPPORTED COMPONENT COMMANDER.//

AKNLDG/Y/INST: BY PHONE TO CDO DSN 471-3201.//

BT

#0237

## COMMUNICATIONS OPERATIONAL TASKING

Following is an excerpt from a 172330Z JUL 01 date time group message from COMNAVSURFGRU MIDPAC to multiple parties concerning communications operational tasking.

A3/ADMIN/2/FOL UNIT ABBREVIATIONS APPLY:  
 EMCC: EHIME MARU RECOVERY OPERATION COMMAND CENTER  
 CNSG: COMMANDER NAVAL SURFACE GROUP MIDDLE PACIFIC  
 CNRH: COMMANDER NAVAL REGION HAWAII  
 PAGE 05 RHHMHAA0137 UNCLAS FOUO  
 OOC: NAVSEA OOC  
 RW2: ROCKWATER 2  
 OHR: OCEAN HERCULES  
 NOS: NAVSEA OIL SKIMMERS  
 CB25 CROWLEY BARGE 250-6  
 CB45 CROWLEY BARGE 450-10  
 SCL: SEA CLOUD  
 SVL: SEA VALOR  
 AOH: AIR OVERFLIGHT HELO  
 MDSU: MOBILE DIVING AND SALVAGE UNIT ONE  
 CGD14: COAST GUARD DISTRICT FOURTEEN SECURITY CRAFT  
 MET: NAVPACMETOCCEN PEARL HARBOR  
 TWR: SUBPAC WEAPONS RETRIEVERS  
 TRB: SUBPAC TORPEDO RETRIEVER  
 CCAM: FLTIMAGCOMPAC COMBAT CAMERA DET  
 NSP: NAVSTA PEARL HARBOR SECURITY PATROL CRAFT  
 HSL: HSL 37  
 SAL: USS SALVOR  
 CHI: JDS CHIHAYA  
 KAI: JAPANESE RESEARCH VESSEL KAIREI  
 PAGE 06 RHHMHAA0137 UNCLAS FOUO  
 SUM: USNS SUMNER  
 CLV: CLEAN ISLANDS COUNCIL OIL SPILL RESPONSE VESSEL  
 ROV: REMOTE OPERATED VEHICLE  
 FARC: FLY AWAY RECOMPRESSION CHAMBER  
 CC: COMMUNICATIONS CONTROL (COMNAVSURFGRU MIDPAC)  
 ACC: ALTERNATE COMMUNICATIONS CONTROL (MDSU-1)  
 A3/ADMIN/2/CRYPTO LOADING ON SECURED CIRCUITS WILL BE CONDUCTED  
 AS FOLLOWS:  
 SWITCH POSITION 1 US KEYMAT. SWITCH POSITION 2 ALLIED KEYMAT.  
 B1/COMPLAN/C3F OPORD 201/ISE/177/201/800R2/0500Z-1600Z  
 B2/COMCHECK/011900Z1AUG01/HF AND DAMA CIRCUITS/TEL/EMCC  
 B3/FREQPLAN/1/GUARD REQUIREMENT IN REMARKS SECTION OF EACH LINE ARE:  
 G - GUARD  
 R - AS REQUIRED  
 L - LISTEN  
 W - WHEN DIRECTED (WHENDI)//  
 PAGE 07 RHHMHAA0137 UNCLAS FOUO  
 B3/FREQPLAN/2/HF FREQ LISTING REFLECTS ACTUAL ASSIGNED FREQ  
 (WINDOW FREQS ARE ENCLOSED IN PARENTHESES)  
 B3/FREQPLAN/3/READ IN FIVE COLUMNS:  
 LINE NUMBER/CKT NAME/FREQ/EMISSION/KEYMAT/GUARD REQUIREMENTS-REMARKS  
 CIRCUIT USAGE IDENTIFICATION:  
 LP154Z/HARBOR OP-CEWN/-/6K00A3E/-/G

## F/V EHIME MARU Recovery and Relocation Report

LP166N3/MDSU-1 TAC 1/-/16K0F3E/-/R  
FREQUENCY EFF 010001Z2AUG01  
LP166N4/MDSU-1 TAC 2/-/16K0F3E/-/R  
FREQUENCY EFF 010001Z2AUG01  
LP177Z/BRIDGE TO BRIDGE(CH 16)/-/16K0F3E/-/G  
LP177Z1/RECOVERY OPS(CH 81)/-/16K0F3E/-/R  
TA200Z/FLT TAC/-/6K00A3E/-/G  
TA201R1/HF CMD NET/-/-/3K00J2E/-/G NOTE 1  
TA201R2/HF CMD NET/-/-/3K00J2E/-/W  
TA201R3/HF CMD NET/-/-/3K00J2E/-/G NOTE 2  
TA201R4/HF CMD NET/-/-/3K00J2E/-/W  
TA201R5/HF CMD NET/-/-/3K00J2E/-/W  
PAGE 08 RHHMHAA0137 UNCLAS FOUO  
TA201R6/HF CMD NET/-/-/3K00J2E/-/W  
ED656Z/SAR COMMON/-/6K00A3E/-/R  
ST800R2/MIDPAC SATCOM DATA/PER REF J/DAMA/-/  
G NOTE 3  
ST800U4/NIPRNET/--3M88G72(SHF)/-/NONE  
ST800U5/SIPRNET (JDISS GENSER)/--3M88G72(SHF)/-/NONE  
ST804U1/MIDPAC SATCOM/PER REF J/DAMA/-/R NOTE 4  
ST804U9/INMARSAT/--3M88G7W(SHF)/-/G  
NOTE 1: FREQ EFF 010001Z2AUG01. USE BETWEEN 0500Z - 1600Z  
(NIGHT TIME FREQ)  
NOTE 2: FREQ EFF 010001Z2AUG01. USE BETWEEN 1601Z - 0459Z  
(DAY TIME FREQ)  
NOTE 3: FREQ EFF 010001Z2AUG01. ST800R2 WILL BE GUARDED CONTINUOUSLY.  
NOTE 4: VOX/DATA SATCOM FREQ WILL BE THE SAME. ST804U1 WILL BE USED  
AS AN ALTERNATE CMD NET.  
F1/SATCOM/PER REF J  
H1/ANTIJAM/REMARKS: REPORT JAMMING EFFECTS TO OSC. OSC WILL  
ISSUE SPECIFIC INSTRUCTIONS WHICH MAY INCLUDE ONE OF THE  
P 172330Z JUL 01 PSN 737222M23  
UNCLAS FOUO //N02300//  
FINAL SECTION OF 02  
FOLLOWING "KICK" CODES:  
KICK-1: MAINTAIN PRIMARY/PRESENT CIRCUIT/FREQ AND ATTEMPT TO WORK  
THROUGH JAMMING.  
KICK-2: SHIFT TO CIRCUIT DESIGNATOR (AS DIRECTED)  
KICK-3: REVERT TO PRIMARY FREQUENCY  
PAGE 04 RHHMHAA0138 UNCLAS FOUO  
I1/CALLSIGN/USE MARITIME VESSEL NAME FOR RECOVERY OPS.  
Y1/SPECINST/APPLICABLE TO ALL:  
1. PHASES 2 THROUGH 5 DEEP WATER RECOVERY SITE COMMUNICATIONS (DWRS)  
WILL CONSIST OF THE FOLL: VHF CHANNEL 81, INMARSAT VOICE, E-MAIL,  
FAX, LAND LINES, NIPRNET AND SIPRNET (WHERE CAPABLE). MESSAGE TRAFFIC  
(WHERE CAPABLE) WILL BE AVAILABLE VIA JMHS ON BOTH SIPRNET AND  
NIPRNET. CELLULAR PHONES HAVE PROVEN TO BE A VIABLE OPTION AND WILL  
BE THE PRIMARY MEANS OF ADMINISTRATIVE VOICE COMMUNICATIONS BETWEEN  
EHIME MARU COMMAND CENTER (EMCC), OCEAN HERCULES (OHR) AND ROCKWATER  
2 (RW2). SENSITIVE VOICE COMMUNICATIONS BETWEEN OHR AND RW2 WILL BE  
VIA INMARSAT. E-MAIL WILL BE THE PRIMARY MEANS OF DATA EXCHANGE WITH  
OHR AND RW2. METOC REAL TIME CURRENT DATA WILL BE PROVIDED TO OHR AND  
RW2 VIA E-MAIL. METOC CURRENT DATA WILL BE PROVIDED TO MDSU-1 VIA  
DAMA SATCOM DATA CIRCUIT.  
3. DURING THE LIFT OF THE EHIME MARU FROM DWRS TO SWRS, EMCC AND THE  
ENVIRONMENTAL TASK COORDINATOR LOCATED AT HAWAII RESPONSE CENTER  
(WITH CLEAN ISLANDS COUNCIL REPRESENTATIVES) WILL COMMUNICATE VIA



LAND LINE AND UNCLASSIFIED E-MAIL.

PAGE 05 RHHMHAA0138 UNCLAS FOUO

4. PHASE 6 AND 8 SHALLOW WATER RECOVERY SITE COMMUNICATIONS (SWRS) WILL CONSIST OF THE FOLLOWING: HF SECURE VOICE, UHF DAMA SATCOM SECURE DATA, MDSU-1 VHF SECURE VOICE FOR USE ON THE BARGE AND VHF CHANNEL 81. MIDPAC SATCOM AND DATA WILL BE THE SAME FREQUENCY. IOT AVOID SWAPPING EQUIPMENT FROM DATA TO VOICE, THE HF COMMAND NET IS DESIGNATED AS THE PRIMARY VOICE COMMAND NET. IF NECESSARY, SATCOM VOICE IS AVAILABLE BY SWAPPING MODES OF OPERATION.
5. IN REGARDS TO COMMUNICATIONS WITH JAPANESE RESEARCH VESSEL KAIREI AND JDS CHIHAYA, COORDINATION IS IN PROGRESS WITH COMNAVFORJAPAN TO ASCERTAIN THEIR COMMUNICATIONS CAPABILITIES. ORGANIC ASSETS WILL BE USED.
6. PHASE 7 WILL INCLUDE BOTH DWRS AND SWRS COMMUNICATIONS.
7. ON 1 AUG, UHF SATCOM AND HF COMMUNICATIONS CHECKS WILL BE CONDUCTED BETWEEN EMCC, MDSU-1 AND USS SALVOR.
8. ALL UNITS MONITOR VHF BRIDGE-TO-BRIDGE CHANNEL 16 FOR SAFETY. DO NOT USE THIS CHANNEL FOR TACTICAL PURPOSES NOR TO DIRECT BOATS.
9. CMD NET HF OPERATOR PROCEDURES: WAIT APPROXIMATELY THREE SECONDS AFTER DEPRESSING PUSH-TO-TALK TO ALLOW FOR CRYPTO SYNCHRONIZATION. COMMAND CENTER WATCH OFFICER WILL PERFORM HOURLY COMM CHECKS WITH MDSU-1.

PAGE 06 RHHMHAA0138 UNCLAS FOUO

10. SATCOM VOICE/DATA NET: IN THE EVENT OF POOR HF PROPAGATION AT SWRS, SATCOM VOICE WILL BE USED AS THE COMMAND NET AND DATA WILL BE ON CALL. THE COMMAND CENTER WATCH OFFICER WILL PERFORM HOURLY COMM CHECKS WITH MDSU-1.
  - (A) FREQUENTLY OBSERVED CKT DISCIPLINE ERRORS WHICH REQUIRE ATTENTION ARE:
    - (1) PASSING ADMINISTRATIVE MESSAGES.
    - (2) RAMBLING CONVERSATIONS USING UP NET TIME. THINK OUT YOUR MESSAGE BEFORE YOU SPEAK ON THE CIRCUIT. SHORT, WELL PLANNED TRANSMISSIONS ARE DIRECTED.
    - (3) IT IS UNDERSTOOD THAT THE STATION YOU ARE CALLING WILL COPY YOUR MESSAGE. THEREFORE, DO NOT USE TERMINOLOGY "BE ADVISED", "HOW COPY", "AT THIS TIME".
    - (4) FOR BREVITY, DO NOT USE "USS" OR "USNS" ON NET. DO NOT USE DOUBLE CALL-UPS AFTER ESTABLISHING COMMS WITH ANOTHER UNIT
    - (5) REPEAT BACKS WILL NOT BE USED. "ROGER, OVER," OR "ROGER OUT," WILL BE USED TO INDICATE YOU HAVE COPIED AND UNDERSTAND MESSAGE. IF NET DID NOT SYNC, CALL TRANSMITTING STATION AND SAY, "SYNC, OVER." IF ONLY PART OF MESSAGE WAS COPIED, CORRECT RESPONSE IS, "SAY AGAIN ALL AFTER..." OR "SAY AGAIN ALL BEFORE..."
11. SATELLITE ACCESS/FREQ AND DAMA CIN ASSIGNMENTS DETAILED IN NCTAMS EASTPAC DAILY COMM STATUS MSG, DTG DD2301ZMMYY. MIDPAC SATCOM ASSIGNMENT MESSAGE WILL BE READDRESSSED TO DIRECT PARTICIPANTS.
12. COMMUNICATION CONTROL, DISCIPLINE AND MESSAGE REDUCTION.
  - A. THE OPERATING SIGNAL "ZYB" WILL BE ASSIGNED TO ALL ADMINISTRATIVE MESSAGE TRAFFIC. FOLLOWING REPORTS NORMALLY ADDRESSED TO NUMEROUS AFLOAT UNITS WILL CONTAIN "ZNZ" OR "ZPW" INSTRUCTIONS AS INDICATED (THESE MESSAGES ARE TIME SPECIFIC (PERISHABLE) AND SHALL NOT BE SERVICED EXCEPT IN EXTREME CASES):
    - (1) POSITION REPORTS - ZPW PLUS 6 HRS
    - (2) ENVIRONMENTAL FORECASTS - ZNZ1
    - (3) CONTACT REPORTS (INCLUDING QUICKREPS - ZNZ1 OR ZPW PLUS 6 HRS

## F/V EHIME MARU Recovery and Relocation Report

B. IMMEDIATE OR HIGHER PRECEDENCE WILL NOT BE ASSIGNED TO ADMINISTRATIVE TRAFFIC UNLESS IT INVOLVES IMMEDIATE SAFETY OF PERSONNEL OR EQUIPMENT.

C. MESSAGE DRAFTER RESPONSIBILITIES: MESSAGE DRAFTERS ARE RESPONSIBLE FOR PROPER ADDRESSING, CLEAR AND CONCISE TEXTUAL COMPOSITION, SELECTION OF APPROPRIATE PRECEDENCE, AND PROPER FORMATTING. MESSAGE ADDEES SHALL BE REVIEWED TO ENSURE ONLY ADDEES PAGE 08 RHHMHAA0138 UNCLAS FOUO WITH A NEED TO KNOW ARE INCLUDED. MESSAGE READDRESSALS SHOULD NOT INCLUDE ANY ADDEES THAT WERE INCLUDED IN THE ORIGINAL DATE-TIME-GROUP OR SUBSEQUENT READDRESSALS. CLOSE ATTENTION TO CSRF/AIGS/CADS IS REQUIRED TO ENSURE EFFICIENT AND COMPLETE DELIVERY. EMAIL CAPABLE UNITS SHOULD MAXIMIZE USE OF CLASSIFIED AND UNCLASSIFIED EMAIL FOR ADMINISTRATIVE MESSAGES.  
Z1/ACKNL DGE/ACKNOWLEDGEMENT AND UNDERSTANDING/COMPLIANCE OF ABOVE TASKING/GUARD REQUIREMENTS ASSUMED WITHIN 72 HOURS OF MSG DTG UNLESS NOTIFIED OTHERWISE.//

BT

#0137

NNNN

00C ....ACT FOR COMNAVSEASYSKOM

08

## OVERALL OPERATIONAL TASKING

Following is an excerpt from the 132200Z JUL 01 message from COMNAVSURFGRU MIDPAC to multiple parties regarding the EHIME MARU OPERATIONAL TASKING

B2/TASKORG/CNSGMP ASSIGNED ON SCENE COMMANDER (OSC)  
 /NAVSEA OOC ASSIGNED RIGGING AND RELOCATION COORDINATOR  
 /MDSU 1 ASSIGNED DIVING COORDINATOR  
 /CPF N46533 ASSIGNED ENVIRONMENTAL COORDINATOR  
 /CPF N00PA ASSIGNED PUBLIC AFFAIRS COORDINATOR  
 PAGE 06 RHHMHAA0056 UNCLAS FOUO  
 /CNR HI ASSIGNED SECURITY COORDINATOR  
 /NAVMETOCEN PH ASSIGNED METOC SUPPORT COORDINATOR  
 C1/GENSIT/1/THE JAPANESE FISHING VESSEL EHIME MARU WAS STRUCK BY THE  
 USS GREENVILLE ON 09 FEB 01. THE VESSEL SANK IN APPROX. 2000 FT OF  
 WATER 10NM SOUTH OF OAHU, HI AT 21-04.8N, 157-49.5W. TWENTY-SIX CREW  
 MEMBERS WERE RESCUED AT THE TIME OF THE ACCIDENT. NINE CREWMEMBERS  
 REMAIN UNLOCATED.

C1/GENSIT/2/ZONES AND AREAS:  
 POINT A DEEP WATER RECOVERY SITE (DWRS) 21-04-48.0N  
 157-49-30.0W  
 POINT B SHALLOW WATER RECOVERY SITE (SWRS) 21-17-29.4N  
 157-56-23.4W  
 POINT C TRANSIT WAY POINT 21-14-00.0N  
 157-54-20.0W  
 POINT D DEEP WATER (FINAL) 21-05-00.0N  
 RELOCATION SITE (FRS) 158-07-00.0W

FLIGHT RESTRICTION ZONES & SURFACE SAFETY ZONES  
 PAGE 07 RHHMHAA0056 UNCLAS FOUO  

POINT	RADIUS	ALTITUDE	TIME PERIOD
DWRS SAFETY ZONE	A	1 NM	0-2000 FT 14 JUL - 31 AUG
DWRS TO SWRS	A TO B	1 NM	0-2000 FT 29-31 AUG

TRANSIT ROUTE  
 SAFETY ZONE  

SWRS SAFETY ZONE	B	1 NM	0-2000 FT 31 AUG - 08 OCT
------------------	---	------	---------------------------

 (WITHIN NAVAL  
 PROTECTIVE AREA - SEE NOTE 1)  

SWRS TO FRS	B TO C	1 NM	0-2000 FT 06-10 OCT
TRANSIT ROUTE	TO D		

 SAFETY ZONE  

FRS SAFETY ZONE	D	1 NM	0-2000 FT 10-11 OCT
-----------------	---	------	---------------------

NOTE 1: THE PEARL HARBOR NAVAL PROTECTIVE AREA INCLUDES THE AREA  
 BOUNDED BY THE FOLLOWING POINTS AND INCLUDES INLAND WATERS OF PEARL  
 HARBOR: 21-18-23N 158-01-24W

PAGE 08 RHHMHAA0056 UNCLAS FOUO  
 21-15-42N 158-01-24W  
 21-15-42N 157-55-15W  
 21-18-15N 157-55-15W

C6/CDREVAL/CRITICAL, HIGHLY VISIBLE OPERATION. SIGNIFICANT  
 INTERNATIONAL PRESS INTEREST EXPECTED, SPECIFICALLY AT COMMENCEMENT  
 OF INITIAL ROV RIGGING OPS AT CURRENT EHIME MARU LOCATION, DURING  
 TRANSIT TO SHALLOW WATER RECOVERY SITE (SWRS), AND DURING DIVE OPS TO  
 RECOVER CREWMEMBERS AT SWRS. RECOVERED CREWMEMBERS SHOULD ONLY BE  
 BROUGHT TO THE SURFACE AT THE COMPLETION OF THE DIVING DAY AND  
 TRANSPORTED TO SHORE AFTER DARK IOT AVOID INAPPROPRIATE MEDIA

## F/V EHIME MARU Recovery and Relocation Report

COVERAGE OF SURVEY AND RECOVERY. IT IS IMPERATIVE TO DOCUMENT AND MAINTAIN A CHAIN OF CUSTODY FOR RECOVERED CREWMEMBERS, PERSONAL EFFECTS, AND ALL OTHER ITEMS RECOVERED FROM THE EHIME MARU. DUE DILIGENCE AND SENSITIVITY TO JAPAN CULTURAL CONCERNS ARE OF UTMOST IMPORTANCE.

D1/MISSION/OVERALL - RECOVER TO THE MAXIMUM EXTENT PRACTICABLE EHIME MARU CREWMEMBERS, PERSONAL EFFECTS, AND CERTAIN CHARACTERISTIC COMPONENTS UNIQUE TO EHIME MARU BY MOVING THE VESSEL TO A SWRS IOT P 132200Z JUL 01 PSN 710048M20

UNCLAS FOUO //N03120//

SECTION 02 OF 05

PERMIT SAFE DIVER ACCESS AND RECOVERY OPERATIONS. ADDITIONALLY, THE EHIME MARU WILL BE PREPARED FOR FINAL RELOCATION TO DEEP WATER BY REMOVING TO THE MAXIMUM EXTENT PRACTICABLE ALL CONTAMINANTS AND PETROLEUM, OIL AND LUBRICANTS (POL). THE EHIME MARU WILL THEN BE PAGE 04 RHHMHAA0057 UNCLAS FOUO RELOCATED TO A FINAL DEEP WATER LOCATION THAT IS BEYOND 12 NM FROM LAND AND BEYOND THE 1000 FATHOM CURVE.

D1/MISSION/COMNAVSURFGRU MIDPAC ASSUMES DUTIES AS ON SCENE COMMANDER (OSC). ADDITIONALLY, CNSGMP WILL:

- STAND UP AND MAN OPERATIONS COMMAND CTR.
- INTEGRATE JMSDF FORCES AND JAPANESE SALVAGE-SURVEY ASSETS TO THE MAX EXTENT POSSIBLE.
- COORD TRANSFER OF RECOVERED CREW MEMBER AND RELEVANT PERSONAL EFFECTS REQUIRED TO EFFECT IDENTIFICATION TO THE MEDICAL EXAMINER (ME), CITY AND COUNTY OF HONOLULU.
- COORD TRANSFER OF RECOVERED PERSONAL EFFECTS AND SHIP UNIQUE CHARACTERISTICS COMPONENTS TO THE GOVERNMENT OF JAPAN CONSULATE GENERAL (CONGEN).
- DEVELOP PROCEDURES FOR COLLECTION OF RECOVERED CREW MEMBERS AND SUPPORTING ITEMS ISO ME RQMNTS.
- COORD OPERATIONAL LOGISTICS SUPPORT.
- PROVIDE COMMS AND IT SUPPORT.
- COORD EMERG MEDICAL RESPONSE FOR ALL PHASES OF OPERATION.
- PROVIDE ON-SCENE SHALLOW WATER SECURITY PERSONNEL.

PAGE 05 RHHMHAA0057 UNCLAS FOUO

D1/MISSION/NAVSEA 00C WILL PROVIDE RELOCATION, RECOVERY AND OIL SPILL RESPONSE SUPPORT IN CONJUNCTION WITH CPF, USCG AND MDSU ONE.

COMPLY WITH ALL ENVIRONMENTAL ASSESSMENT (EA) REQUIRED MITIGATION ACTIONS. SURVEY AND DOCUMENT DWRS. VIDEO DOCUMENT OPERATIONAL ASPECTS OF RELOCATION OPERATIONS. ADDITIONAL DETAILS WILL BE PROVIDED IN SEPARATE OPTASKS.

D1/MISSION/MDSU ONE - CONDUCT DIVING OPERATIONS TO RECOVER MISSING CREWMEMBERS FFT TO MEDICAL EXAMINER (ME) CITY AND COUNTY OF HONOLULU. RECOVER TO THE MAXIMUM EXTENT PRACTICAL ALL CREWMEMBER PERSONAL EFFECTS, AND OSC DIRECTED EHIME MARU UNIQUE COMPONENTS. INTEGRATE AND TRAIN SRF DIVERS ISO SWRS OBJECTIVES. COMPLY WITH ALL APPLICABLE EA MITIGATING ACTIONS. VIDEO DOCUMENT ALL OPERATIONS MAINTAINING TRACEABLE CUSTODY OF RECORDED VIDEO TAPES. ASSIST WITH NAVSEA 00C RELOCATION ACTIONS AS REQD. REMOVE, SECURE, OR CONTAIN ALL LOOSE TOPSIDE MATERIAL. REMOVE POL TO MAXIMUM EXTENT POSSIBLE. MAINTAIN TRACEABLE CUSTODY DOCUMENTATION OF ALL ITEMS REMOVED FROM THE EHIME MARU. BE PREPARED TO PROVIDE BARGE TO SUPPORT JMSDF DIVERS.

PAGE 06 RHHMHAA0057 UNCLAS FOUO

D1/MISSION/COMPACAREA COGARD WILL ESTABLISH SAFETY ZONES; PROVIDE AFLOAT SECURITY AT DEEP WATER SITE, PLANNED ROUTE TO SHALLOW WATER SITE AND SUBSEQUENT ROUTE TO FINAL DEEP WATER RESTING SITE; PROVIDE

SECURITY RESPONSE SUPPORT AT SHALLOW WATER SITE AS REQUESTED, MEDICAL EVACUATION ASSISTANCE, AND OIL SPILL MANAGEMENT TEAM MEMBERS; AND PROVIDE OVERFLIGHT MONITORING OF DWRS FOR UNPLANNED POL RELEASE. ADDITIONAL SECURITY DETAILS WILL BE PROVIDED IN THE OPTASK SECURITY. D1/MISSION/COMNAVREG HAWAII - SUPPORT AS FOLLOWS: SHORE SECURITY DURING CREW MEMBER AND PERSONAL EFFECTS TRANSFER OPERATIONS, AFLOAT SECURITY RESPONSE AT SHALLOW WATER SITE (PEARL HARBOR NAVAL PROTECTIVE AREA) AS REQUIRED, OILY WASTE TREATMENT SERVICES, OIL SPILL MANAGEMENT TEAM MEMBERS, TRANSFER OF FUEL OIL TO FUEL DEPOT, AND EMERGENCY MEDICAL SUPPORT. PROVIDE SECURITY AND PERSONNEL ACCESS CONTROL FOR COMMAND CENTER AND TRANSIT VESSELS BETWEEN SHORE AND CROWLEY BARGE. PROVIDE CRANE AND TRANSPORTATION SUPPORT AS REQUIRED BY OSC. ADDITIONAL DETAILS WILL BE PROMULGATED IN THE OPTASK DIVOPS, OPTASK LOGISTICS, OPTASK SECURITY, OPTASK ENVIRONMENT, AND OPTASK MEDICAL.

PAGE 07 RHHMHAA0057 UNCLAS FOUO

D1/MISSION/NAVPACMETOCEN PEARL HARBOR HI WILL PROVIDE WEATHER FORECASTING SUPPORT. PROVIDE REALTIME SURFACE AND SUBSURFACE METEOROLOGICAL, CURRENT, AND ENVIRONMENTAL DATA AT DEEP WATER SITE AND SHALLOW WATER SITE. PROVIDE MODELING SERVICES FOR PROJECTED DISPERSAL OF UNPLANNED POL RELEASE. PROVIDE DAILY WEAX BRIEF WITH FOUR DAY FORECAST. ADDITIONAL DETAILS WILL BE PROMULGATED IN THE OPTASK METOC.

D1/MISSION/FLTIMAGCOMPAC SAN DIEGO PROVIDE COMBAT CAMERA PERSONNEL TO DOCUMENT RELOCATION AND RECOVERY OPERATIONS FOR THE F/V EHIME MARU. (COORDINATE WITH FLTIMAGCOMLANT FOR UNDERWATER CAPABILITY.) SCOPE OF COVERAGE WILL BE DEFINED IN THE OPTASK DIVOPS, OPTASK RELOCATION AND OPTASK PUBLIC AFFAIRS. ADDITIONALLY, FLTIMAGCOMPAC WILL BE REQUIRED TO PROVIDE IMAGING DUPLICATION SERVICES ISO OSC REQUIREMENTS. (MAKE AT LEAST THREE COPIES OF VIDEO TAPES DEPICTING ANY ASPECT OF CREWMEMBER AND PERSONAL EFFECTS RECOVERY PRODUCED BY ROV, DIVERS OR COMBAT CAMERA).

D1/MISSION/COMSUBPAC PROVIDE TWR-TRB LOGISTICS SUPPORT. COORD WATERSPACE MANAGEMENT REQUIREMENTS TO DECONFLICT MISSION OPERATING

PAGE 08 RHHMHAA0057 UNCLAS FOUO

AREAS.

D1/MISSION/SALVOR STANDBY TO ASSIST AS NECESSARY THROUGHOUT OPERATIONS AND CONDUCT DIVEOPS TO SURVEY SWRS AFTER EHIME MARU HAS BEEN RELOCATED TO FRS AND CONDUCT ANY NECESSARY CLEAN UP OF SWRS TO INCLUDE REMOVAL OF THE DIVING BARGE MOORING SYSTEM. BE PREPARED TO PROVIDE VIDEO AND STILL DOCUMENTATION OF ASSIGNED OPERATIONS.

D1/MISSION/COMEODGRU ONE - PROVIDE TWO FLY AWAY RECOMPRESSION CHAMBER SYSTEMS WITH CREW FOR SHALLOW WATER DIVE OPERATIONS. PROVIDE EOD RESPONSE AS REQD.

D1/MISSION/CINCPACFLT PAO - COORD ALL PA ISSUES FOR THE OPERATION. ENSURE OSC IS NOTIFIED PRIOR TO ANY MEDIA EVENT OR PRESS RELEASE.

D1/MISSION/CINCPACFLT N46533 - IDENTIFY AND TRACK RQD EA MITIGATING ACTIONS. COORD AND MANAGE UNPLANNED POL RESPONSE.

D1/MISSION/HSL 37 - PROVIDE PAX TRANSFER AS REQD BY OSC. PROVIDE OVERFLIGHT OBSERVATION AS REQD BY OSC. PROVIDE AIRBORNE SUPPORT FOR P 132200Z JUL 01 PSN 710053M16

UNCLAS FOUO //N03120//

SECTION 03 OF 05

VIDEO DOCUMENTATION AS REQ BY OSC. ASSIST OSC WITH AIRSPACE MANAGEMENT IN THE EVENT OF AN UNPLANNED POL RELEASE. STANDBY AS ALTERNATE MEDEVAC ASSET.

PAGE 04 RHHMHAA0058 UNCLAS FOUO

## F/V EHIME MARU Recovery and Relocation Report

E1/PLAN/THIS OPERATION WILL BE CONDUCTED IN TEN PHASES:

PHASE 0 - SEARCH AND FEASIBILITY STUDY. COMPLETED.

PHASE 1 - ENVIRONMENTAL ASSESSMENT/MITIGATIONS. COMPLETED.

PHASE 2 - MOBILIZATION OF RECOVERY FORCES. NAVSEA CONTRACTED VESSELS MV OCEAN HERCULES, MV ROCKWATER 2, AND CROWLEY BARGE MOBILIZATION IN PROGRESS. EXPECT OCEAN HERCULES ON STATION MID JULY; ROCKWATER 2 ON STATION EARLY AUGUST; CROWLEY BARGE TO ARRIVE IVO HAWAII LATE AUGUST.

PHASE 3 - RIGGING BY ROV AT 2000 FEET. OCEAN HERCULES WILL PREP EHIME MARU FOR FURTHER RIGGING BY ROCKWATER 2 (REMOVING TOPSIDE INTERFERENCES-MIDMAST AND NETTING). ROCKWATER 2 WILL RIG EHIME MARU FOR LIFTING AND RELOCATION TO SWRS.

PHASE 4 - DEEP WATER LIFT AND RELOCATION TO APPROX 115 FT DEPTH. SKED TO BEGIN APPROX LATE AUGUST/EARLY SEPTEMBER BY NAVSEA CONTRACTORS. ROCKWATER 2 WILL LIFT

EHIME MARU APPROX 100 FT ABOVE BOTTOM AND TRANSPORT VESSEL TO WITHIN 3NM OF SWRS. FINAL LIFT FOR TRANSIT TO SWRS WEAX DEPENDENT. ROV WILL MONITOR EHIME MARU DURING RELOCATION.

PHASE 5 - POST LIFT ROV SURVEY/RECOVERY AT 2000 FT. SKED IMMEDIATELY AFTER LIFT AND RELOCATION. OPTIONS TO

PAGE 05 RHHMHAA0058 UNCLAS FOUO

UTILIZE JAPANESE RESEARCH VESSEL KAIREI AND ROV KAIKO TO CONDUCT BOTTOM SEARCH OF DWRS IOT RETRIEVE ANY DEBRIS FOUND UPON REMOVAL OF EHIME MARU AND DOCUMENT SITE POST LIFT AND TRANSIT ARE UNDER REVIEW AND COORD WITH APPROPRIATE AUTH.

OTHER OPTIONS INCLUDE JDS CHIHAYA OR USS SALVOR.

PHASE 6 - CREWMEMBER RECOVERY AT SWRS. SLATED LATE AUGUST THROUGH EARLY OCTOBER. CROWLEY BARGE WILL SUPPORT DIVE OPS ON STATION AT SWRS. INTERNAL DIVE OPS WILL COMMENCE 48 HOURS

AFTER EHIME MARU RELOCATION FOLLOWING A CROWLEY ROV EXTERNAL INSPECTION (24 HOURS AFTER ARRIVAL AT SWRS) AND A MDSU-1 EXTERNAL DIVE SURVEY. ALL DIVE OPS TO RECOVER CREWMEMBERS AND PERSONAL EFFECTS WILL BE DOCUMENTED

WITH UNDERWATER VIDEO. SRF YOKOSUKA DIVERS WILL ASSIST MDSU1 IN RECOVERY OF CREWMEMBERS, PERSONAL EFFECTS AND CHARACTERISTIC COMPONENTS FROM EHIME MARU. MDSU-1 WILL PREPARE EHIME MARU FOR RELOCATION TO FINAL DEEP WATER RELOCATION SITE. (REMOVAL OF POL AND CONTAMINANTS TO MAXIMUM EXTENT PRACTICABLE). MDSU-1 WILL CONDUCT CLOSE OUT INSPECTION FOLLOWED BY A JMSDF DIVER CLOSE OUT INSPECTION TO CONFIRM COMPLETION OF RECOVERY OPS. MDSU-1 WILL SEAL

PAGE 06 RHHMHAA0058 UNCLAS FOUO

AND SECURE SPACES FOLLOWING THESE INSPECTIONS PRIOR TO THE RELOCATION OF THE EHIME MARU TO THE FRS. JDS CHIHAYA WILL BE IVO OPAREA TO PROVIDE SUPPORT.

PHASE 7 - PREPARE AND RELOCATE EMPTY VESSEL TO DEEP WATER. SKED APPROX EARLY-MID OCTOBER. CROWLEY BARGE WILL LIFT EHIME

MARU FROM THE SWRS AND BE TOWED BY NAVSEA CONTRACTED ASSET TO FINAL DEEP WATER SITE OUTSIDE 12NM FROM LAND AND BEYOND THE 1000 FATHOM CURVE. DIVE OPS WILL BE CONDUCTED TO INSPECT THE SWRS AFTER EHIME MARU HAS BEEN RELOCATED.

PHASE 8 - SHALLOW WATER RECOVERY SITE CLEAN UP. ASSIGNED ASSETS WILL CONDUCT SURVEY, DOCUMENTATION AND CLEAN UP OF DEBRIS OF SWRS AFTER THE EHIME MARU HAS BEEN RELOCATED TO THE FRS.

PHASE 9 - REDEPLOYMENT.

E3/DTLDTASK/DELINEATED IN ASSOCIATED OPTASKS, PROMULGATED SEPCOR.

H4/REFPOINT/DEEP WATER RECOVERY SITE (DWRS) 21-04.8N 157-49.5W

(CURRENT POSITION OF EHIME MARU).  
H4/REFPOINT/SHALLOW WATER RECOVERY SITE (SWRS) 21-17-29.4N 157-56-  
PAGE 07 RHHMHAA0058 UNCLAS FOUO  
23.4W (PLANNED RELOCATION SITE OF EHIME MARU FOR DIVING OPS).  
H4/REFPOINT/DEEP WATER (FINAL) RELOCATION SITE (FRS) 21-5N 158-7W  
(PLANNED FINAL RELOCATION SITE OF EHIME MARU OUTSIDE 12 NM FROM LAND  
AND BEYOND THE 1000 FATHOM CURVE).  
I1/AIRASSET/USCG PROVIDE SAR HELO AND MEDEVAC HELO SERVICES AS  
REQUIRED. REQUEST INTEGRATE OVERFLIGHT OF DWRS AND SWRS AS  
APPROPRIATE INTO DAILY SURVEILLANCE FLIGHT AND REPORT OBSERVATIONS TO  
EMCC. ADDITIONAL INFORMATION PROVIDED IN THE OPTASK ENVIRONMENT,  
OPTASK MEDICAL AND OPTASK DIVEOPS.  
I4/AIRTASK/IN THE EVENT OF AN EMERGENCY OR CASUALTY, USCG PROVIDE  
HELO ASSET ON SHORT NOTICE TO PROVIDE SAR AND MEDEVAC SERVICES.  
Q1/LOGISTIC/SUBPAC PROVIDE TWR ASSET TO TRANSPORT RECOVERED  
CREWMEMBERS AND PERSONAL EFFECTS FROM SHALLOW WATER RECOVERY SITE TO  
SHORE STATION AS REQUIRED. CONDUCT TWICE DAILY TRIPS TO SWRS.  
PROVIDE PAX AND SMALL CARGO TRANSPORT TO-FROM DWRS AS REQUIRED.  
DETAILED INFORMATION WILL BE PROVIDED IN OPTASK LOGISTICS.  
PAGE 08 RHHMHAA0058 UNCLAS FOUO  
Q1/LOGISTIC/PROVIDING COMMANDS WILL FUND ALL COSTS OF  
OPERATIONS, DEPLOYMENT AND REDEPLOYMENT. INCREMENTAL CONTINGENCY  
COSTS WILL BE REPORTED VIA YOUR ADMINISTRATIVE FUNDING CHAIN OF  
COMMAND. ALL COMMAND CENTER LOGISTIC REQUIREMENTS NEED TO BE  
FORWARDED TO CNSGMP N7. DETAILED INFORMATION WILL BE PROVIDED IN  
OPTASK LOGISTICS.  
R1/COMSTASK/COMMUNICATIONS WILL BE IAW OPTASK COMMS. FOLLOWING  
ABBREVIATIONS WILL BE USED:  
EMCC: EHIME MARU RECOVERY OPERATION COMMAND CENTER  
CNSG: COMMANDER NAVAL SURFACE GROUP MIDDLE PACIFIC  
CNRH: COMMANDER NAVAL REGION HAWAII  
OOC: NAVSEA OOC  
RW2: ROCKWATER 2  
OHR: OCEAN HERCULES  
NOS: NAVSEA OIL SKIMMERS  
CB25 CROWLEY BARGE 250-6  
CB45 CROWLEY BARGE 450-10  
P 132200Z JUL 01 PSN 710050M13  
UNCLAS FOUO //N03120//  
SECTION 04 OF 05  
SCL: SEA CLOUD  
SVL: SEA VALOR  
AOH: AIR OVERFLIGHT HELO  
MDSU: MOBILE DIVING AND SALVAGE UNIT ONE  
PAGE 04 RHHMHAA0059 UNCLAS FOUO  
CGD14: COAST GUARD DISTRICT FOURTEEN SECURITY CRAFT  
MET: NAVPACMETOCCEN PEARL HARBOR  
TWR: SUBPAC WEAPONS RETRIEVERS  
TRB: SUBPAC TORPEDO RETRIEVER  
CCAM: FLTIMAGCOMPAC COMBAT CAMERA DET  
NSP: NAVSTA PEARL HARBOR SECURITY PATROL CRAFT  
HSL: HSL 37  
SAL: USS SALVOR  
CHI: JDS CHIHAYA  
KAI: JAPANESE RESEARCH VESSEL KAIREI  
SUM: USNS SUMNER  
CLV: CLEAN ISLANDS COUNCIL OIL SPILL RESPONSE VESSEL

## F/V EHIME MARU Recovery and Relocation Report

ROV: REMOTE OPERATED VEHICLE

FARC: FLY AWAY RECOMPRESSION CHAMBER

V1/SAR/ALL SAR EFFORTS WILL BE CONDUCTED IAW CURRENT INSTRUCTIONS. X1/REPINST/COMMENCING 13JUL01, COMNAVSURFGRU MIDPAC WILL TRANSMIT DAILY SITREP TO CINCPACFLT NLT 2000Z (1000 HST). STARTING 24 HOURS PRIOR TO THE LIFT OF EHIME MARU FOR RELOCATION TO SWRS, THE SITREP PAGE 05 RHHMHAA0059 UNCLAS FOUO WILL BE PROVIDED TWICE DAILY NLT 0700Z (2100 HST) AND 2000Z (1000 HST). WHEN CONDUCTING OPERATIONS, ATTACHED UNITS SUBMIT SITREP INPUTS TO EMCC VIA E-MAIL (PRI) OR VOICE (ALT) NLT ONE HOUR PRIOR TO THE ABOVE DUE TIMES. SITREP FORMAT WILL BE PROVIDED SEPCOR. ANY ADDITIONAL REPORTABLE INCIDENTS WILL BE REPORTED IAW STANDARD NAVAL REPORTING PROCEDURES.

X1/REPINST/DOCUMENT ALL EVENTS AND PROVIDE FINAL REPORT INPUTS TO OSC UPON THE COMPLETION OF CREWMEMBER RECOVERY AND FINAL VESSEL RELOCATION. USE NAVSEAINST 4740.8A AS GUIDANCE. ALL SUPPORT ORGANIZATIONS SUBMIT LESSONS LEARNED IN NLL FORMAT TO COMNAVSURFGRU MIDPAC UPON COMPLETION OF MISSION.

Y1/SPECINST/SAFETY - SAFE CONDUCT OF ALL OPERATIONS IS PARAMOUNT. AT NO POINT SHALL THE SAFETY OF PERSONNEL OR EQUIP BE COMPROMISED IN THIS OPERATION. MANNED DIVING OPERATIONS INSIDE THE EHIME MARU REQ CONSTANT ATTENTION AND DILIGENCE TO ENSURE SAFE MISSION EXECUTION.

Y1/SPECINST/COORDINATE ALL PUBLIC AFFAIRS MATTERS WITH CINCPACFLT PAO. THE PUBLIC AFFAIRS APPROACH TO THIS DEPLOYMENT IS ACTIVE.

PAGE 06 RHHMHAA0059 UNCLAS FOUO

CINCPACFLT PA HAS BEEN COORDINATING WITH ALL AGENCIES INVOLVED. UNITS MUST COORDINATE ALL REQUESTS FROM THE MEDIA WITH CINCPACFLT PUBLIC AFFAIRS REP FOR THIS OPERATION, MR. JON YOSHISHIGE, (808)471-3769, DSN 315 471-3769. EMAIL YOSHISJ@CPF.NAVY.MIL.

Y1/SPECINST/WHEN DEALING WITH MEMBERS OF THE PRESS, PERSONNEL SHOULD BE OPEN, HONEST AND FORTHRIGHT. ALLOW COMMON SENSE AND OPERATIONS SECURITY TO BE YOUR GUIDE. KEEP IN MIND THE FOLLOWING POINTS:

(1) UNIT COMMANDERS, SERVICE MEMBERS, AND SPOKESPERSONS SHOULD NOT SPECULATE OR RESPOND TO (QUOTE) WHAT IF (UNQUOTE) QUESTIONS.

(2) UNIT COMMANDERS, SERVICE MEMBERS AND SPOKESPERSONS SHOULD STAY WITHIN THEIR AREA OF EXPERTISE AND PERSONAL KNOWLEDGE. OTHER QUESTIONS SHOULD BE REFERRED TO CINCPACFLT PA MR. JON YOSHISHIGE.

(3) ALL DISCUSSIONS WILL BE ON THE RECORD.

(4) THE FOLLOWING CONTINGENCY STATEMENT IS APPROVED FOR USE, (QUOTE) WITH THE DETERMINATION THIS OPERATION WILL NOT RESULT IN SIGNIFICANT ENVIRONMENTAL IMPACTS, THE NAVY HAS CONTRACTED WITH PRIVATE COMPANIES TO DESIGN, ENGINEER AND EXECUTE THE PLAN TO LIFT EHIME MARU OFF THE OCEAN FLOOR, TRANSPORT IT TO SHALLOW WATER, AND RELOCATE IT TO DEEP WATER UPON COMPLETION OF THE RECOVERY OPERATION.

PAGE 07 RHHMHAA0059 UNCLAS FOUO

THIS DEPLOYMENT IS PART OF THE LARGER U.S. EFFORT TO ASSIST THE FAMILIES AND FELLOW CREWMEMBERS OF THOSE STILL MISSING AND DETERMINE THE FACTS OF THIS INCIDENT WHILE LIMITING THE IMPACT TO THE ENVIRONMENT. WE DO NOT YET KNOW HOW LONG THIS OPERATION WILL LAST BUT EVERY EFFORT WILL BE MADE TO ACCOMPLISH OUR MISSION. (UNQUOTE)

(5) RELEASE AUTHORITY FOR DEPLOYING UNITS IS DELEGATED TO THAT COMMAND.

(6) RELEASE AUTHORITY FOR SPECIFICS OF RECOVERY OPERATIONS IS DELEGATED TO CINCPACFLT.

(7) REFER MEDIA QUERIES TO CINCPACFLT COMM (808) 471-3769, DSN 315-471-3769 AND REFER MEDIA TO CINCPACFLT WEBSITE WWW.CPF.NAVY.MIL FOR



F/V EHIME MARU Recovery and Relocation Report

IMAGES, DOCUMENTS, NEWS RELEASES AND THE ENTIRE ENVIRONMENTAL ASSESSMENT.

(8) MEDIA CENTER WILL BE ESTABLISHED. DETAILS TO BE PROVIDED SEPCOR. Y2/SPECINFO/JMSDF AND JAPANESE RESEARCH VESSELS HAVE BEEN INVITED TO ASSIST IN THE RECOVERY OPERATIONS. INTEGRATION GUIDANCE AND DETAILS TO FOLLOW SEPCOR.

PAGE 08 RHHMHAA0059 UNCLAS FOUO

Y2/SPECINFO/CULTURAL SENSITIVITY - ALWAYS CONSIDER JAPANESE NATIONAL AND CULTURAL SENSITIVITIES, AND DUE CONSIDERATION TO SURVIVORS AND FAMILY MEMBERS OF THE UNLOCATED CREWMEMBERS IN ALL ASPECTS OF THIS MISSION. CULTURAL TRAINING IS AVAIL UPON REQUEST FOR ALL FORCES ASSIGNED BY CONTACTING THE OSC.

Y2/SPECINFO/MAJOR DECISION POINTS (BY PHASE FROM THE FAILURE POINT ANALYSIS STUDY (FPAS)) FOLLOW:

DECISION POINT	STATUS	
PHASE 0 - FEASIBILITY STUDY		COMPLETE
PHASE 1 - IN COMPLIANCE WITH NEPA		COMPLETE
- SECTION 10 ACHIEVED	COMPLETE	
- APPROVE FONSI	COMPLETE	
PHASE 2 - REQUIRED ASSETS UNDER CONTRACT		COMPLETE
- COILED TUBE DRILLING VALIDATION		
TEST SAT	COMPLETE	
- ALL VESSELS AND EQUIPMENT ARRIVE IN HONOLULU AS SKED	PENDING	
PHASE 3 - ACHIEVE CLEARANCE REQ T FOR LIFT AND RELOCATION TO SWRS (MAST REMOVAL)	PENDING	

P 132200Z JUL 01 PSN 710055M18

UNCLAS FOUO //N03120//

FINAL SECTION OF 05

- COILED TUBE DRILLING SUCCESSFUL	PENDING	
PHASE 4 - ASSETS IN PLACE FOR UNPLANNED POL RELEASE	PENDING	
- LIFT SUCCESSFUL	PENDING	

PAGE 04 RHHMHAA0060 UNCLAS FOUO

- RIGGING SATISFACTORY (ROV CHECK)	PENDING	
- DAYLIGHT, WEATHER & SEA STATE FAVORABLE (AT POINT 3 NM FROM SWRS)	PENDING	

- LIFT FOR FINAL TRANSIT SUCCESSFUL	PENDING	
PHASE 6 - POL BOOMS AND SKIMMERS IN STANDBY		PENDING

- EHIME MARU STABLE AFTER 48 HOURS (AFTER RELOCATION TO SWRS)	PENDING	
- SEA STATE SAFE FOR DIVE OPS	PENDING	
- (EHIME MARU) SAFE FOR DIVER ENTRY	PENDING	
- ALL CREWMEMBERS LOCATED	PENDING	
- HOT TAP OR OIL REMOVAL	PENDING	

PHASE 7 - WEATHER CONDITIONS SUITABLE FOR RELOCATION	PENDING	
- (EHIME MARU) SAFE TO TRANSPORT	PENDING	

Y2/SPECINFO/ PERTINENT INFORMATION AND LINKS TO THIS SALVAGE OPERATION CAN BE FOUND ON THE EHIME MARU COMMAND CENTER WEBSITES AT: [HTTP://WWW.MIDPAC.NAVY.MIL/CC](http://WWW.MIDPAC.NAVY.MIL/CC) AND [HTTP://WWW.MIDPAC.NAVY.SMIL.MIL/CC.HTM](http://WWW.MIDPAC.NAVY.SMIL.MIL/CC.HTM) //

BT

#0056

NNNN

00C ....ACT FOR COMNAVSEASYSOM

08 PMS307

## METOC OPERATIONAL TASKING

Following is an excerpt of a 021556Z Aug 01 date time group message from COMNAVSURFGRU MIDPAC to multiple parties defining EHIME MARU Meteorological and Oceanographic tasking.

SECTION 01 OF 03

OPER/EHIME MARU RECOVERY OPERATIONS//

MSGID/OPTASK/COMNAVSURFGRU MIDPAC/001/JUL//

SUBJ/EHIME MARU OPTASK METOC//

RMKS/1. THIS IS A NAVAL PACIFIC METEOROLOGY AND OCEANOGRAPHY-JOINT TYPHOON WARNING CENTER (NPMOC-JTWC) OPTASK COORDINATED BY COMNAVSURFGRU MIDPAC.

A1/REF/A/APP 4(A) VOL. I

A1/REF/B/CINCPACFLT OPOD 001-01 DTG 151841ZJUN01

A1/REF/C/COMTHIRDFLT OPOD 001-01 DTG 250355ZJUN01

A1/REF/D/CNSGMP EHIME MARU RECOVERY CONOPS DTG 291709ZJUN01

A1/REF/E/CINCPACFLT EXECUTIVE ORDER 111923ZJUL01

A1/REF/F/COMTHIRDFLT EXECUTIVE ORDER 131733ZJUL01

A1/REF/G/COMNAVSURFGRU MIDPAC EHIME MARU RECOVERY OPGEN 132200ZJUL01

A1/REF/H/EHIME MARU RELOCATION ENVIRONMENTAL ASSESSMENT (EA)

A1/REF/I/CINCPACFLTINST 4740.1J (SALVAGE AND RECOVERY OPERATIONS)

A1/REF/J/COMNAVSEASYS COM 00C SER 0021 OF 13 APR 2001

PAGE 05 RHHMHAA0175 UNCLAS FOUO

A1/REF/K/COMNAVSURFGRU MIDPAC OPTASK COMMS 172330ZJUL01//

A2/PERIOD/13JUL01-15NOV01 (NOT TO EXCEED 15NOV01)//

A3/ADMIN/NPMOC-JTWC COMMANDING OFFICER ASSIGNED METOC SUPPORT COORDINATOR (MSC). ALL METOC ASSETS WILL REPORT TO THE MSC.

A3/ADMIN/1/NAVAL OCEANOGRAPHIC OFFICE (NAVO) WILL BE RESPONSIBLE FOR OCEANOGRAPHIC DATA COLLECTION AND PROCESSING.

A3/ADMIN/2/FLEET NUMERICAL METEOROLOGY OCEANOGRAPHY CENTER (FNMO) WILL PROVIDE HIGH-RESOLUTION NUMERICAL MODEL DATA TO MSC AND NAVO.

A3/ADMIN/3/NAVAL RESEARCH LAB (NRL) STENNIS WILL PROVIDE EXPERIMENTAL LONG-RANGE OCEAN SWELL FORECASTS.

A3/ADMIN/4/NPMOC-JTWC PEARL HARBOR WILL COORDINATE AND PROVIDE ON-SCENE METOC SUPPORT TO OPERATION.

B1/CONDUCT/THIS OPTASK PROVIDES THE PARTICIPATING ELEMENTS WITH SPECIFIC POLICY AND REQUIREMENTS WITH RESPECT TO METOC SUPPORT FOR EHIME MARU RECOVERY OPERATIONS.

C1/METOC OPERATIONS/PARTICIPATING ELEMENTS WILL PROVIDE SPECIFIC METOC SUPPORT TO MSC AS FOLLOWS.

C1/METOC OPERATIONS/1/NAVOCEANO:

1. RECOVER PREVIOUSLY DEPLOYED ACOUSTIC DOPPLER CURRENT PROFILER (ADCP) MOORED ARRAYS AFTER 30 DAYS (COMPLETE LUNAR CYCLE) AT EHIME MARU PRESENT LOCATION AND AT SHALLOW WATER RECOVERY SITE. PROVIDE NECESSARY SOFTWARE AND TECHNICIAN TO VIEW DATA AT NPMOC-JTWC FOLLOWING ARRAY RETRIEVAL.

2. DEPLOY TWO TABS BUOYS DURING PHASES 4 THROUGH 9, WHICH WILL TRANSMIT TIME-AVERAGED DATA AT 30-MINUTE INTERVALS. ONE BUOY WILL HAVE A METEOROLOGY PACKAGE AND CURRENT MEASUREMENT CAPABILITY AT MULTIPLE DEPTHS AND WILL BE DEPLOYED TO 21-17-27N0 157-55-38W4 EAST OF SHALLOW WATER RECOVERY SITE. SECOND BUOY WILL BE DEPLOYED TO

21-17-17N9 157-59-00W7, WEST OF PEARL HARBOR CHANNEL ENTRANCE, AND WILL HAVE ONLY A SINGLE DEPTH CURRENT CAPABILITY.

3. CONDUCT BOTTOM CORING AND SUBSTRATE COLLECTION AND ANALYSIS AT SHALLOW WATER RECOVERY SITE AND PROVIDE ANALYZED RESULTS TO MSC NLT 06 AUG 2001.

4. CONDUCT HIGH RESOLUTION BATHYMETRY SURVEY TO INCLUDE SHALLOW WATER RECOVERY AREA AND TRANSIT ROUTE FROM SHALLOW WATER RECOVERY AREA TO DEEP WATER FINAL RELOCATION SITE. PROVIDE BOTH PAPER AND ELECTRONIC PRODUCTS BY 17 JULY 01. INVESTIGATE ROUTE PROPOSALS WITH FLY-THRU VISUALIZATION SOFTWARE FOR COMMAND CENTER CONSIDERATIONS. PROVIDE DATA TO COMMAND CENTER AND NPMOC-JTWC FOR ROUTE PLANNING AND PUBLIC AFFAIRS RELEASE.

PAGE 07 RHHMHAA0175 UNCLAS FOUO

5. PRODUCE 3D COLOR BATHYMETRY CHARTS OF TRACK FROM WRECK TO SHALLOW WATER RECOVERY SITE AND SHALLOW WATER RECOVERY SITE TO FINAL RELOCATION SITE, PROVIDING RESULTS TO EMCC AND RIGGING AND RELOCATION COORDINATOR.

6. PROVIDE PHYSICAL OCEANOGRAPHER WITH COASTAL SPECIALTY TO NPMOC-JTWC DURING ROUTE PLANNING AND FROM ONE WEEK PRIOR TO LIFT OPERATIONS UNTIL VESSEL IS DE-FUELED (APPROX TWO WEEKS TOTAL). INTEND TO OPERATE FROM NPMOC-JTWC, AND WILL MAN COMMAND CENTER DURING CRITICAL TIME SENSITIVE OPERATIONS.

7. PROCURE AND DEPLOY SHIP-MOUNTED ADCP TO PROVIDE NEAR REAL-TIME CURRENT MEASUREMENTS TO 600M DEPTH. EXPECT ADCP HOST VESSEL TO PRECEDE LIFT VESSEL ALONG RECOVERY TRACK DURING PHASES 4 AND 5. EXACT STATIONING TO BE DETERMINED BY VESSEL'S MASTER WHILE ON SCENE. ALL DATA WILL BE PROCESSED ONBOARD AND SENT TO NPMOC-JTWC AND LIFT VESSEL FOR DISTRIBUTION TO ALCON AS OFTEN AS PROCESSING PERMITS.

8. PROVIDE 4 TIMES DAILY SWAF FIELDS TO MSC FOR AOI.

9. PROVIDE TWICE DAILY HI RES WAM FIELDS TO MSC.

C1/METOC OPERATIONS/2/FNMOC: PROVIDE HIGH RESOLUTION (81, 27 AND 9 KILOMETER AT 2-HOUR TIME STEPS) COAMPS WIND FIELDS TO NAVOCEANO FOR INCLUSION INTO SWAFS MODEL. PROVIDE 4 TIMES DAILY  
PAGE 08 RHHMHAA0175 UNCLAS FOUO

HIGH RESOLUTION MODEL DATA TO MSC FOR PURPOSE OF OIL DISPERSION FORECASTING.

C1/METOC OPERATIONS/3/NRL STENNIS: PROVIDE EXPERIMENTAL LONG-RANGE SWELL FORECAST PRODUCT TO SUPPORT ASSESSMENT OF SWELL HEIGHTS AND ARRIVAL TIMES DURING PHASES 3 THRU 9. ENSURE PRODUCT AVAILABLE AT NRL WEB SITE DURING PHASES 3 THRU 9. NOTIFY NPMOC-JTWC ANYTIME PRODUCT WILL NOT BE AVAILABLE DURING THIS PERIOD.

C1/METOC OPERATIONS/4/NPMOC-JTWC:

1. PROVIDE METEOROLOGICAL ANALYSES, FORECASTS, AND BRIEFING SUPPORT TO EMCC COMMENCING 13 JUL 01.

2. PROVIDE ENVIRONMENTAL OBSERVER ABOARD LIFT VESSEL TO PROVIDE REAL TIME SURFACE WEATHER OBSERVATIONS. INFO WILL BE PROVIDED TO NPMOC-JTWD FOR DISTRIBUTION TO EMCC AND ALCON.

3. PROVIDE REAL-TIME AND FCST DATA TO NOAA HAZMAT OIL PLUME DISPERSION MODELING PERSONNEL.

4. MAINTAIN DIRECT COMMUNICATIONS WITH EMCC FOR METOC SUPPORT. ESTABLISH NIPRNET WEB BASED LOCATION FOR DISPLAY OF ALL RELEVANT METOC PRODUCTS, TO BE UPDATED IMMEDIATELY AS NEW INFORMATION BECOMES AVAILABLE THROUGHOUT OPERATION.

5. COORDINATE WITH CPF FOR RECOVERY AND RETURN SHIPPING OF ALL  
PAGE 09 RHHMHAA0175 UNCLAS FOUO

REAL-TIME CURRENT METER BUOYS USED DURING LIFT OPERATION.

6. NPMOC-JTWC WILL PROVIDE DETAILED WEB BASED SUPPORT VIA EHIME MARU

## F/V EHIME MARU Recovery and Relocation Report

WEBSITE, AT WWW.NPMOC.NAVY.MIL/METOC/FORECASTS/INDEX2.HTM (LOWER CASE) COMMENCING 13 JULY 2001. THIS WILL BE A PASSWORD PROTECTED SITE. CONTACT NPMOC-JTWC OR EMCC WATCH OFFICER FOR ACCESS.

7. PROVIDE SUPPORT AT NPMOC-JTWC FOR NAVO OCEANOGRAPHER.

C2/COORD/NPMOC-JTWC IS OPERATIONAL COMMANDER OF THE METOC EFFORT. ADDITIONAL RESPONSIBILITIES INCLUDE:

C2/COORD/1/PROMULGATION OF ANY TASKING OR SPECIAL SUPPORT REQUIRED BY OTC OR OSC NOT ADDRESSED IN THIS OPTASK.

C2/COORD/2/RECOMMEND SETTING OF HEAVY WEATHER CONDITIONS OF READINESS DURING THE OPERATION. RECOMMEND SORTIE IF OPERATIONAL UNITS ARE THREATENED BY HEAVY WEATHER OR TROPICAL CYCLONE. RECOMMENDATIONS PASSED TO OSC VIA EMCC.

C2/COORD/3/ENSURE TIMELY DISSEMINATION OF METOC RELATED PRODUCTS TO INCLUDE: CRITICAL WEATHER OBSERVATIONS, OCEANOGRAPHIC BATHYMETRIC ANALYSES TO ALCON VIA APPROPRIATE COMM PATH.

D1/MISSION/PROVIDE DETAILED, NEAR REAL-TIME METOC SUPPORT TO EHIME MARU RECOVERY OPERATIONS BY COLLECTING, PROCESSING, AND DISTRIBUTING WEATHER DATA FROM MULTIPLE SOURCES TO OSC, EMCC, AND CONTRACTED P 021556Z AUG 01 PSN 866871M36

UNCLAS FOUO//N03120//

SECTION 02 OF 03

OPER/EHIME MARU RECOVERY OPERATIONS//

MSGID/OPTASK/COMNAVSURFGRU MIDPAC/001/JUL//

SUBJ/EHIME MARU OPTASK METOC//

ASSETS IOT PROVIDE END USER WITH UP TO DATE, ACCURATE INFORMATION FOR PLANNING AND OPERATION EXECUTION.

E1/PLAN/METOC SUPPORT TO RECOVERY OPERATIONS WILL COMMENCE WITH THE START OF PHASE 3. SPECIFIC SUPPORT TO EACH PHASE OF THE OPERATION IS AS FOLLOWS:

E1/PLAN/1/PHASE 3. SUPPORT WILL COMMENCE ON 13JUL01.

1. NPMOC-JTWC:

A. TWICE DAILY FORECAST DISSEMINATED VIA AUTODIN, FLEET BROADCAST AND WEBSITE. OTHER METHODS OF DISSEMINATION ARE AVAILABLE UPON REQUEST. OPAREA AND ZONES AS DEFINED PARA H4.

B. DEDICATED UNCLASSIFIED PASSWORD PROTECTED WEBSITE INCORPORATING ALL OPERATION SPECIFIC METOC DATA AND PRODUCTS.

C. 12 HOURLY 3KM RESOLUTION COAMPS SFC WIND FIELDS TO SUPPORT OIL PAGE 05 RHHMHAA0176 UNCLAS FOUO

DISPERSION AND CONTAMINENT DECISION TIMELINES.

D. ON CALL METOC REP TO PROVIDE STAFF BRIEFINGS TO UNIFIED COMMAND CENTER AS DIRECTED.

E. HIGH RESOLUTION METEOROLOGICAL SATELLITE IMAGERY.

F. SURFACE OBSERVATION DATA FROM ALL AVAILABLE SOURCES.

G. ANY ADDITIONAL METOC DATA OR PRODUCTS AS DIRECTED BY MSC.

2. NAVO:

A. FOUR TIMES DAILY SWAFS DATA PROVIDED VIA WEBSITE LINK.

B. CURRENT METER DATA GENERATED BY BOTTOM MOORED ADCP'S ALREADY IN PLACE. DATA TO BE PROVIDED NLT 06AUG01 TO OSC AND EMCC VIA NPMOC-JTWC.

C. TWICE DAILY 9KM OR HIGHER RESOLUTION WAVE ANALYSIS MODEL (WAM) FIELDS PROVIDED VIA WEBSITE LINK.

3. NRL STENNIS:

CONTINUATION OF EXPERIMENTAL LONG RANGE SWELL FORECAST PROVIDED VIA WEBSITE LINK.

4. FNMOC:

PROVIDE 9KM, 27KM AND 81KM COAMPS SFC WIND FIELDS TO NAVOCEANO FOR INCORPORATION INTO SWAFS MODEL. ALSO PROVIDE 6 HOURLY 3KM, 9KM,

27KM COAMPS RUNS TO NPMOC-JTWC FOR PURPOSE OF OIL DISPERSION  
PAGE 06 RHHMHAA0176 UNCLAS FOUO  
FORECASTING, VIA UNCLAS WEBSITE.

E1/PLAN/2/PHASE 4. SUPPORT WILL COMMENCE ONE WEEK PRIOR TO  
COMMENCEMENT OF VESSEL LIFT AND TRANSIT TO SHALLOW WATER SITE AND  
TERMINATE UPON TRANSITION TO PHASE 5. ALL PARTICIPANTS LISTED IN  
SECTION E1 PARA 1 TO CONTINUE ALL PHASE 3 SUPPORT ITEMS AND PROVIDE  
ADDITIONAL SUPPORT LISTED BELOW.

1. NPMOC-JTWC:

A. STAND UP 24HR METOC SUPPORT CELL LOCATED AT NPMOC-JTWC. MSC WILL  
MAINTAIN COMMUNICATIONS VIA EMAIL AT CDO(AT SIGN)NPMOC.NAVY.MIL  
(LOWERCASE) AND VIA PHONE AT 471-0068/0090. MSC WILL PROVIDE THE  
FOLLOWING:

(1) SIX HOURLY OPAREA METOC FORECASTS (FOR SPECIFIC ZONES). OPAREA  
AND ZONES ARE DEFINED IN PARA H4.

A. METOC REP TO PROVIDE ON-SITE BRIEFING AND STAFF SUPPORT AT  
UNIFIED COMMAND CENTER AS DIRECTED.

B. TWO EXPERIENCED METOC OBSERVERS TO BE DEPLOYED ABOARD LIFT  
VESSEL. OBSERVERS WILL PROVIDE SFC WEATHER OBSERVATIONS TO NPMOC-  
JTWC.

E1/PLAN/3/PHASES 5 AND 6. SUPPORT TO COMMENCE UPON VESSEL MOORING  
AT SHALLOW WATER RECOVERY SITE. ALL PARTICIPANTS LISTED IN SECTION  
PAGE 07 RHHMHAA0176 UNCLAS FOUO

E1 PARA 1 TO CONTINUE ALL PHASE 3 SUPPORT ITEMS AND PROVIDE  
ADDITIONAL SUPPORT LISTED BELOW:

1. NPMOC-JTWC:

A. ONE EXPERIENCED METOC OBSERVER DEPLOYED ABOARD DIVING BARGE.  
REQUIREMENT FOR ON SITE OBSERVING WILL BE REEVALUATED AS NEEDED.

E1/PLAN/4/PHASE 7. SUPPORT TO COMMENCE UPON COMPLETION OF VESSEL  
DEFUELING AND CREWMEMBER RECOVERY. ALL PARTICIPANTS LISTED IN  
SECTION E1 PARA 1 TO CONTINUE ALL PHASE 3 SUPPORT ITEMS AND  
PROVIDE ADDITIONAL SUPPORT LISTED BELOW:

1. NPMOC-JTWC:

A. TWO METOC OBSERVERS TO BE DEPLOYED UPON CROWLEY BARGE OR TOWING  
VESSEL.

E1/PLAN/5/METOC THRESHOLDS:

1. THE FOLLOWING CRITICAL METOC THRESHOLDS ARE ESTABLISHED BY THE  
ENVIRONMENTAL ASSESSMENT AND FINDING OF NO SIGNIFICANT IMPACT FOR  
THE INTITIAL LIFT.

A. WINDS FROM NORTH THRU NORTHEAST WITH SPEEDS 10 TO 15 KNOTS  
ARE CONSIDERED FAVORABLE FOR ALL PHASES OF OPERATION.

B. WINDS FROM EAST-NORTHEAST THROUGH EAST ARE MARGINAL, EAST-  
SOUTHEAST THRU WEST ARE UNFAVORABLE DUE TO INCREASED POSSIBILITY  
PAGE 08 RHHMHAA0176 UNCLAS FOUO

OF OIL REACHING SHORELINE.

C. SUSTAINED WIND SPEEDS GREATER THAN 25KTS ARE UNFAVORABLE.

D. COMBINED WAVE HEIGHTS GREATER THAN 2.5 METERS (8 FEET) ARE  
UNFAVORABLE DURING VESSEL LIFT AND RELOCATION (PHASE 4) AND DURING  
DIVING OPERATIONS (PHASES 5 AND 6).

E. OCEAN CURRENTS WITH ONSHORE SET AND WITH SPEEDS GREATER THAN  
1 KNOT ARE CONSIDERED UNFAVORABLE.

F. THUNDERSTORM ACTIVITY WITHIN 10NM OF LIFT VESSEL OR DIVING  
BARGE IS UNFAVORABLE.

G. TROPICAL CYCLONE ACTIVITY IMPACTING SOUTHERN OAHU WITHIN 72 HOURS  
IS UNFAVORABLE.

2. IAW REF H, THE FINAL MOVEMENT TO THE SWRS WILL BE TIMED TO  
COINCIDE WITH FAVORABLE WIND SPEED AND DIRECTION, CURRENTS, AND

## F/V EHIME MARU Recovery and Relocation Report

TIDES. THE FOLLOWING THRESHOLDS APPLY.

A. WIND SPEED AND DIRECTION: SUSTAINED SPEED LESS THAN 20 KNOTS, NORTH THROUGH EAST.

B. CURRENTS: LESS THAN 1 KNOT.

C. TIDES: TIMED TO COINCIDE WITH LEAST TIDAL CURRENT INFLUENCE.

D. SEA STATE: COMBINED SEA AND SWELL LESS THAN 8 FEET.

F1/ASSET/METOC SUPPORT WILL BE PROVIDED BY THE FOLLOWING:

PAGE 09 RHHMHAA0176 UNCLAS FOUO

F1/ASSET/1/MSC STAFF, CONSISTING OF THREE SENIOR METOC FORECASTERS, THREE LOCAL FORECASTERS AND THREE OCEANOGRAPHIC SPECIALISTS.

F1/ASSET/2/UNIFIED COMMAND CENTER SUPPORT WILL CONSIST OF TWO STAFF METOC REPS.

F1/ASSET/3/PERSONNEL DEPLOYED ABOARD LIFT VESSEL AND DIVING BARGE WILL BE QUALIFIED SURFACE WEATHER OBSERVERS.

H4/REFERENCE POINTS/SPECIFIC ZONES WILL BE REFERENCED IN EHIME MARU OPAREA FORECAST AS FOLLOWS:

1. ZONE 1 (SHALLOW WATER ZONE) VCNTY EWA BEACH SOUTH TO 21-16-00N0 158-00-00W4 EAST TO 21-16-00N0 157-52-00W0 THEN NORTH TO VCNTY HONOLULU CHANNEL ENTRANCE.

2. ZONE 2 (TRANSIT ZONE) BARBERS POINT COASTAL TO DIAMOND HEAD (EXCLUDING ZONE 1) SOUTH TO 21-12-00N6 157-47-45W3 THEN WEST TO 21-12-00N 158-07-30W4.

3. ZONE 3 (DEEP WATER ZONE) 21-12-00N6 158-07-30W4 SOUTH TO 21-00-00N3 158-10-10W6 THEN EAST TO 21-00-00N3 157-45-00W2 THEN NORTH TO 21-12-00N6 157-47-45W3.

R1/COMSTASK/COMMUNICATIONS WILL BE IAW OPTASK COMMS. REF K IDENTIFIES ABBREVIATIONS TO BE USED.

X1/REPINST/1/NPMOC-JTWC PROVIDES METEOROLOGICAL AND OCEANOGRAPHIC P 021556Z AUG 01 PSN 866873M38

UNCLAS FOUO//N03120//

FINAL SECTION OF 03

OPER/EHIME MARU RECOVERY OPERATIONS//

MSGID/OPTASK/COMNAVSURFGRU MIDPAC/001/JUL//

SUBJ/EHIME MARU OPTASK METOC//

FORECASTS AND IMPACTS TO COMNAVSURFGRU MIDPAC PER REF B.

X1/REPINST/2/UNRESTRICTED VOICE RPTS WILL BE MADE VIA BRIDGE-TO-BRIDGE RADIO (CHANNEL 81 OR 16) AND CELLULAR PHONE TO EMCC WATCH OFFICER. RPTS SENSITIVE IN NATURE WILL BE PROVIDED VIA INMARSAT PHONE OR VIA COMMERCIAL VHF SECURE HAND HELD RADIO TO EMCC WATCH OFFICER. DATA REPORTS WILL BE PROVIDED TO EMCC WATCH OFFICER VIA INMARSAT FAX OR E-MAIL.

EMCC WATCH OFFICER: (808) 474-4199/4205

EMCC FAX: (808) 474-4231

EMCC E-MAIL: EMCC(AT)MIDPAC.NAVY.MIL//

X1/REPINST/3/COMMENCING 13JUL01, COMNAVSURFGRU MIDPAC WILL TRANSMIT DAILY SITREP TO CINCPACFLT NLT 2000Z (1000 HST). STARTING 24 HOURS PRIOR TO THE LIFT OF EHIME MARU FOR RELOCATION TO SWRS, THE SITREP PAGE 05 RHHMHAA0177 UNCLAS FOUO

WILL BE PROVIDED TWICE DAILY NLT 0700Z (2100 HST) AND 2000Z (1000 HST). WHEN CONDUCTING OPERATIONS, RRC WILL SUBMIT SITREP INPUTS TO EMCC VIA E-MAIL (PRI) OR VOICE (ALT) NLT ONE HOUR PRIOR TO THE ABOVE DUE TIMES. ANY ADDITIONAL REPORTABLE INCIDENTS WILL BE REPORTED IAW STANDARD NAVAL REPORTING PROCEDURES.

X1/REPINST/4/MSC WILL COORDINATE DOCUMENTATION OF ALL METOC EVENTS AND PROVIDE FINAL REPORT INPUTS TO OSC UPON THE COMPLETION OF CREWMEMBER RECOVERY AND FINAL VESSEL RELOCATION. MSC WILL USE NAVSEAINST 4740.8A AS GUIDANCE. ALL MSC ASSIGNED SUPPORT

F/V EHIME MARU Recovery and Relocation Report

ORGANIZATIONS SUBMIT LESSONS LEARNED IN NLL FORMAT TO RRC UPON COMPLETION OF MISSION IOT FORWARD FINAL LESSONS LEARNED TO COMNAVSURFGRU MIDPAC ASAP.

Y1/SPECINST/SAFETY - SAFE CONDUCT OF ALL OPERATIONS IS PARAMOUNT. AT NO POINT SHALL THE SAFETY OF PERSONNEL OR EQUIP BE COMPROMISED IN THIS OPERATION. MANNED DIVING OPERATIONS INSIDE THE EHIME MARU REQ CONSTANT ATTENTION AND DILIGENCE TO ENSURE SAFE MISSION EXECUTION. Y1/SPECINST/RRC COORDINATE ALL PUBLIC AFFAIRS MATTERS WITH CINCPACFLT PAO. THE PUBLIC AFFAIRS APPROACH TO THIS DEPLOYMENT IS ACTIVE. CINCPACFLT PA HAS BEEN COORDINATING WITH ALL AGENCIES INVOLVED. RRC WILL COORDINATE ALL REQUESTS FROM THE MEDIA WITH CINCPACFLT PUBLIC PAGE 06 RHHMHAA0177 UNCLAS FOUO

AFFAIRS REP FOR THIS OPERATION, MR. JON YOSHISHIGE, (808) 471-3769, DSN 315 471-3769. EMAIL YOSHISJ@CPF.NAVY.MIL. FOR ADDITIONAL MEDIA COORDINATION GUIDANCE, REFER TO REF G AND THE EHIME MARU OPTASK PUBLIC AFFAIRS.

Y2/SPECINFO/JMSDF AND JAPANESE RESEARCH VESSELS HAVE BEEN INVITED TO ASSIST IN THE RECOVERY OPERATIONS. FOLLOW INTEGRATION GUIDANCE AND DETAILS, PROMULGATED BY COMNAVSURFGRU MIDPAC SEPCOR.

Y2/SPECINFO/CULTURAL SENSITIVITY - ALWAYS CONSIDER JAPANESE NATIONAL AND CULTURAL SENSITIVITIES, AND DUE CONSIDERATION TO SURVIVORS AND FAMILY MEMBERS OF THE UNLOCATED CREWMEMBERS IN ALL ASPECTS OF THIS MISSION. CULTURAL TRAINING IS AVAIL UPON REQUEST FOR ALL FORCES ASSIGNED BY CONTACTING THE OSC.

Y2/SPECINFO/ PERTINENT INFORMATION AND LINKS TO THIS SALVAGE OPERATION CAN BE FOUND ON THE EHIME MARU COMMAND CENTER WEBSITE AT: [HTTP://WWW.MIDPAC.NAVY.MIL/CC](http://www.midpac.navy.mil/cc) AND [HTTP://WWW.MIDPAC.NAVY.SMIL.MIL/CC.HTM.//](http://www.midpac.navy.smil.mil/cc.htm)

BT  
#0175  
NNNN

00C ....ACT FOR COMNAVSEASYSOM  
08 PMS307





F/V EHIME MARU Recovery and Relocation Report

RUHPOAA/COMSEVENTHFLT  
RHMFIUU/COMNAVFORJAPAN YOKOSUKA JA//N3//  
RUYNAAC/COMNAVFORJAPAN YOKOSUKA JA//N3//  
RUEHKO/USDAO TOKYO JA//NAVATT//  
RUHEMBA/HSL THREE SEVEN KANEOHE BAY HI  
RHMFIUU/NAVOCEANO STENNIS SPACE CENTER MS//00/01/WSC//  
RUCFCFLC/NAVOCEANO STENNIS SPACE CENTER MS//00/01/WSC//  
RUWDQAA/COMPACAREA COGARD ALAMEDA CA//O/M//  
RULSJGA/COMDT COGARD WASHINGTON DC  
RUWDQAA/COGARD MSO HONOLULU HI  
RUWDQAA/COGARD AIRSTA BARBERS PT HI  
RUWDQAA/COMCOGARDGRU HONOLULU HI  
RUYNJPN/MSO DOP JMSDF JA//HOP//  
RUYNJPN/CINCSDFLT JMSDF JA//N3//  
RUYNJPN/COMFLTSUBFORCE JMSDF JA//N3//  
PAGE 03 RHHMHAA0015 UNCLAS FOUO  
RUEHKO/AMEMBASSY TOKYO  
RUALSFJ/COMUSJAPAN YOKOTA AB JA  
RUEJDCA/DISA WASHINGTON DC  
RHHJJAA/JICPAC HONOLULU HI  
RHMFIUU/DLA FT BELVOIR VA  
RUEADLA/DLA FT BELVOIR VA  
RUETIAA/DIRNSA FT GEORGE G MEADE MD  
RHMFIUU/NIMA HQ BETHESDA MD  
RUEANQA/NIMA HQ BETHESDA MD  
RHMFIUU/NAVSHIPREPFAC YOKOSUKA JA//100/200/300/330/338//  
RUYNABW/NAVSHIPREPFAC YOKOSUKA JA//100/200/300/330/338//  
RUHVPA/15ABW HICKAM AFB HI//CC//  
RUHVAAA/CDRUSACILHI HICKAM AFB HI//JJJ//  
RUWDLBA/COMSUBDEVRON FIVE SAN DIEGO CA  
RUCBFDF/MOBDIVSALU TWO  
RUEOBUA/USNS SUMNER  
RUHEMDQ/COMNAVSURFGRU MIDPAC//N01/N3/N43/N7/N8/N14//  
RHMFIUU/NAVDIVESALVTRACEN PANAMA CITY FL  
RUCTMGE/NAVDIVESALVTRACEN PANAMA CITY FL  
RUHEMDQ/COMNAVSURFGRU MIDPAC//N01//  
PAGE 04 RHHMHAA0015 UNCLAS FOUO  
BT  
UNCLAS FOUO //N04740//  
MSGID/GENADMIN/CNSGMP//  
SUBJ/062000Z SITREP FOR RECOVERY OPERATIONS OF THE JAPANESE FISHING  
VESSEL EHIME MARU//  
REF/A/OPGEN/COMNAVSURFGRU MIDPAC/132200ZJUL01//  
REF/B/ORDER/CINCPACFLT/111923ZJUL01//  
REF/C/ORDER/COMTHIRDFLT/131733ZJUL01//  
NARR/REF A IS CNSGMP OPGEN FOR RECOVERY OPERATIONS OF THE JAPANESE FV  
EHIME MARU. REF B IS CPF EXORD FOR RECOVERY OPERATIONS OF THE  
JAPANESE FV EHIME MARU. REF C IS C3F EXORD FOR RECOVERY OPERATIONS  
OF THE JAPANESE FV EHIME MARU.//  
RMKS/1. GENERAL SITUATION AS OF 061000W AUG 01:  
A. UNITS ON SCENE:  
UNIT LOCATION COMMENTS  
SEA CLOUD/CROWLEY PHARBOR (V3)  
BARGE 250-6  
CNSGMP PHARBOR OSC  
MDSU-1 PHARBOR DIVER TRNG  
ROCKWATER 2 (RW2) HNL PIER ONE ONLOAD EQUIP/SUPPLIES

**F/V EHIME MARU Recovery and Relocation Report**

PAGE 05 RHHMHAA0015 UNCLAS FOUO

USS SALVOR PHARBOR (B20)

B. WEATHER AT RECOVERY SITE:

WINDS (KTS): ENE 15-20G25 KTS

TEMP (DEG F): 78

SEAS (FT): 06-08 FT

SWELL (FT): ESE 02-04

C. 24 HR FCST AT RECOVERY SITE:

CLOUD COVER: PARTLY CLOUDY OCCASIONALLY MOSTLY CLOUDY.

PRECIP: NONE.

VIS (NM): UNRESTRICTED.

WINDS (KTS): ENE 15-20G25.

TEMP (DEG F): MAX: 82 MIN: 75 SST: 78.

SEAS (FT): ESE 06-08.

SWELL (FT): ESE 05-07.

SWELL PERIOD (SEC): 8.

COMBINED SEAS (FT): ESE 06-08.

2. OPERATIONS.

PAGE 06 RHHMHAA0015 UNCLAS FOUO

A. TASKS COMPLETED:

(1) USCG REPORTS NO AIR OR SURFACE CONTACTS IN RESTRICTED AREA.

(2) OUTFITTING AND SYSTEMS TEST OF RW2 ROV SUITES, COILED TUBE

DRILLING EQUIPMENT, AND EQUIPMENT VANS CONTINUES. NINETY-TWO

PERCENT OF EQUIPMENT SPOTTED ON DECK AND SECURED FOR SEA. VHF

COMMS ESTABLISHED BTWN RW2 AND EMCC. SABER SECURE COMMS AND

IRIDIUM COMMS CHECKS COMPLETE.

(3) BERTH SHIFT OF SEA CLOUD AND CROWLEY BARGE 250-6 TO PH VICTOR 3

COMPLETE.

(4) SRF YOKOSUKA DIVERS ARRIVED. INTEGRATED WITH MDSU DIVERS. ONE

SUBSTITUTE DIVER SKED TO ARRIVE 08 AUG 01.

(5) COMMENCED DIVER MISSION IN WATER TRNG AT MDSU ONE.

B. PROBLEMS ENCOUNTERED:

(1) SMIT NAVAL ARCHITECTS REQUESTED ADDITIONAL WELDMENTS ON LIFTING  
PLATES; CORRECTIVE ACTION IN PROGRESS.

(2) ADDITIONAL LIFTING SLINGS ARE BEING FABRICATED IN SINGAPORE;

ITEMS ARE NOT IN THE CRITICAL PATH.

C. FUTURE INTENTIONS:

PAGE 07 RHHMHAA0015 UNCLAS FOUO

(1) RW2 COMPLETE SPOTTING AND SECURE FOR SEA OF REMAINING EQUIPMENT.

POUR STBD LIFT WIRE SOCKET. COMPLETION OF SYSTEM CHECKS, WELDING BY

061600 AUG 01. RW2 RELOCATE TO FUELING PIER FOR REFUEL. UNDERWAY

EARLY AM 07 AUG 01 FOR DWRS.

(2) PLACE REMAINING 2 ANCHORS AND 2 PILES AT SWRS SITE.

(3) USCG CONT DAILY OVERHEAD FLIGHTS AT DWRS.

(4) MEET WITH FEDERAL AND STATE ON SCENE COORDINATORS TO COORDINATE

OIL SPILL RESPONSE PLAN.

(5) MDSU DIVER TRG CONT THROUGH 17AUG01.

3. PUBLIC AFFAIRS:

A. REC'D CALLS FRM KHNL, KYODO NEWS SERVICE, NIPPON TV REQUESTING  
DEPARTURE TIME/DATE OF RW2 TO DWRS.

B. LOCAL AND JAPANESE PRESS CONTINUE TO PUBLISH ARTICLES DESCRIBING  
THE SALVAGE AND RECOVERY OPERATION.

4. OSC COMMENTS:

A. HOSTED RADM UTLEY, USCG, COMMANDER, 14TH COAST GUARD DISTRICT AT  
0800 OPT MTG. PROVIDED OVERVIEW OF OPS AND CURRENT STATUS.

B. EMCC LOCATED BLDG 54, BISHOP POINT.

PAGE 08 RHHMHAA0015 UNCLAS FOUO

**F/V EHIME MARU Recovery and Relocation Report**

EMAIL ADDRESS: EMCC@MIDPAC.NAVY.MIL.

PHONE NUMBERS ARE:

COMMAND CENTER DIRECTOR: (808) 473-0304

WATCH OFFICER: (808) 474-4199/474-4205/474-4231(FAX)

EMCC MONITORING BRIDGE-BRIDGE VHF CH16 AND CH81.

PERTINENT INFORMATION AND LINKS TO THIS RECOVERY OPERATION CAN BE

FOUND ON THE EHIME MARU COMMAND CENTER WEBSITE AT:

[HTTP://WWW.CPF.NAVY.MIL/EHIMEMARURECOVERY](http://www.cpf.navy.mil/ehimemarurecovery) AND

[HTTP://WWW.MIDPAC.NAVY.SMIL.MIL/CC.HTM](http://www.midpac.navy.smil.mil/cc.htm)

C. STATUS OF OTHER UNITS:

UNIT	LOCATION	COMMENTS
CROWLEY BARGE 450-10	LONG BEACH CA	LOADING EQUIP EDD: 07AUG01
EDA PEARL HARBOR:	20AUG01	
USNS SUMNER	AT SEA	CONDUCTING NAVO MISSION
ETA PAPA HOTEL:	13AUG01	

BT

#0015

NNNN

08 ....INFO FOR COMNAVSEASYSOM

00C 00 01 05P 913 PMS307

## LOGISTICS OPERATIONAL TASKING

Following is an excerpt from a 070300Z Aug 01 date time group message from COMNAVSURFGRU to multiple parties regarding EHIME MARU logistics operational tasking.

MSGID/OPTASK/COMNAVSURFGRU MIDPAC//  
SUBJ/EHIME MARU OPTASK LOGISTICS//  
RMKS/1. THIS IS A COMNAVSURFGRU MIDPAC OPTASK COORDINATED BY  
COMNAVSURFGRU MIDPAC.  
PAGE 04 RHHMHAA0028 UNCLAS  
A1/REF/A/APP 4(A) VOL. I  
A1/REF/B/CINCPACFLT OPORD 001-01 DTG 151841ZJUN01  
A1/REF/C/COMTHIRDFLT OPORD 001-01 DTG 250355ZJUN01  
A1/REF/D/CNSGMP EHIME MARU RECOVERY CONOPS DTG 291709ZJUN01  
A1/REF/E/CINCPACFLT EXECUTIVE ORDER 111923ZJUL01  
A1/REF/F/COMTHIRDFLT EXECUTIVE ORDER 131733ZJUL01  
A1/REF/G/COMNAVSURFGRU MIDPAC EHIME MARU RECOVERY OPGEN  
A1/REF/H/EHIME MARU RELOCATION ENVIRONMENTAL ASSESSMENT (EA)  
A1/REF/I/CINCPACFLTINST 4740.1J (SALVAGE AND RECOVERY OPERATIONS)  
A1/REF/J/COMNAVSEASYS COM 00C SER 0021 OF 13 APR 2001//  
A2/PERIOD/13JUL01-15NOV01 (NOT TO EXCEED 15NOV01)//  
A3/ADMIN/COMNAVSURFGRU MIDPAC ASSIGNED LOGISTICS COORDINATOR (LC)  
B1/CONDUCT/COMNAVSURFGRU MIDPAC LC WILL ASSIST LOGISTICS REQUIREMENTS  
FOR THE CREW MEMBER RECOVERY OF THE F/V EHIME MARU INCLUDING  
MOBILIZATION OF RECOVERY FORCES, DEEP WATER LIFT AND RELOCATION, POST  
LIFT ROV SURVEY, CREWMEMBER RECOVERY AT SHALLOW-WATER SITE,  
RELOCATION TO DEEP WATER, AND REDEPLOYMENT.  
C1/DETAILS/COMNAVSURFGRU MIDPAC LC WILL CONSOLIDATE LOG REQUIREMENTS  
FOR OTHER TASK COORDINATORS REQUIRING ASSISTANCE. THE LC WILL DEVELOP  
LOGISTICS PLANS AND TASKS BASED ON THESE REQUIREMENTS. ACTIVITIES  
PAGE 05 RHHMHAA0028 UNCLAS  
TASKED TO PROVIDE SUPPORT WILL DO SO UTILIZING EXISTING FUNDING TO  
THE MAXIMUM EXTENT POSSIBLE. IF EXISTING FUNDING IS NOT ADEQUATE TO  
SUPPORT TASKS ASSIGNED, REQUEST ADDITIONAL FUNDS FROM COMPTROLLER IN  
YOUR ADMINISTRATIVE CHAIN OF COMMAND.  
C2/COORD/COMNAVSURFGRU MIDPAC LC WILL TAKE DIRECTION FROM THE OSC.  
THE LC WILL ASSIST WITH ALL TASK COORDINATORS PERTAINING TO MATTERS  
REQUIRING LOG SUPPORT. ANTICIPATED LOG RQMNTS INCLUDE - LOCAL SVCS  
INCLUDING TEMPORARY PIER WHARFAGE FOR CONTRACTOR BARGES AND TUGS,  
SEWAGE AND OILY WASTE TRANSFER AND DISPOSAL, AND PERIODIC WATER TAXI  
SERVICE; LOG SUPPORT FOR ANTICIPATED AND UNANTICIPATED RELEASES  
DURING EACH PHASE OF THE RECOVERY OPERATION; DISPOSAL OF ALL  
RECOVERED OILY WASTE, SOLID WASTE AND HAZARDOUS MATERIAL; OILED  
WILDLIFE RESPONSE AND FOR DECONTAMINATION SERVICES AS NEEDED;  
ADDITIONAL FUNDING TO SUPPORT MATERIAL REQUIREMENTS FOR THIS  
OPERATION. THE LC WILL BE RESPONSIBLE FOR THE LOG NEEDS OF THE  
COMMAND CENTER.  
D1/MISSION/THE LC WILL PROVIDE OVERARCHING LOG SUPPORT TO ALL TASK  
COORDINATORS TO MEET LOG REQUIREMENTS NECESSARY FOR CONDUCT OF ALL  
PHASES OF THE CREWMEMBER RECOVERY. AS SUCH, LC WILL ENGAGE WHEN  
INDIVIDUAL CELLS ENCOUNTER DIFFICULTY ARRANGING LOGISTICS SUPPORT AND  
PAGE 06 RHHMHAA0028 UNCLAS  
WHEN REQUIRED LOGISTICS SUPPORT CROSSES CELL RESPONSIBILITIES.

D2/PREPLAN/

1. LC HAS PLANNED THE LOG SUPPORT OF THE COMMAND CENTER AND IS ACTIVELY OBTAINING MATERIAL TO STAND UP THE COMMAND CENTER AT THE ESSM SITE AT BISHOP POINT. THE LC HAS PLANNED CRANE AND VEHICLE SUPPORT, WATER TAXI SUPPORT, AND PERSONAL EFFECTS TRANSFER PLAN. THE LC IS COORDINATING WITH THE RRC AND ENVIRONMENTAL COORDINATOR ON OILY WASTE, SOLID WASTE, AND HAZARDOUS MATERIAL TRANSFER PLANS.

2. DETAILED LOGISTICS REQUIREMENTS FOR COMSUBPAC TWR WATER TAXI SUPPORT IS AS FOLLOWS.

A. DURING DEEP WATER AND TRANSIT PHASES REMAIN ON CALL AS NEEDED TO ASSIST IN LOGISTICS RUNS.

B. DURING SHALLOW WATER DIVING PHASE PROVIDE DAILY LOGISTICS SERVICE TO CROWLEY 450-10 BARGE MOORED AT THE SHALLOW WATER SITE. PROVIDE SHUTTLE SERVICE TO THE SHALLOW WATER SITE AT APPROX 0500 HST AND APPROX 1900 HST DAILY. BE PREPARED TO RESPOND TO EMERGENCY LOGISTICS REQUIREMENTS AS NEEDED.

C. PERFORM DAILY TRANSFER OF RECOVERED PERSONAL EFFECTS FROM CROWLEY BARGE 450-10, OR AS NEEDED. TRANSFER PERSONAL EFFECTS UPON RETURN FROM 0500 HST LOGISTICS RUN UNLESS VOLUME OF RECOVERED MATERIAL REQUIRES MORE RUNS.

E1/PLAN/EACH CELL IS RESPONSIBLE FOR ALL LOGISTIC ARRANGEMENTS WITHIN ITS SCOPE OF OPERATIONS. EACH CELL LEAD WILL:

1. BE RESPONSIBLE FOR PROVIDING FACILITIES, SERVICES, AND MATERIAL IN SUPPORT OF THE CELL MISSION TASKING.

2. ARRANGE FOR FUELING, MAINTENANCE AND REPAIR OF VESSEL RESOURCES, AS REQD.

E2/PLAN/SPECIFIC DETAILS RE HANDLING OF PERSONAL EFFECTS, UNIQUE SHIP ITEMS, AND DEBRIS WILL BE PROVIDED IN THE ASSOCIATED SOP SEPCOR.

Q1/LOGISTIC/TASK COORDINATORS PROVIDE ANY NEW LOG REQUIREMENTS TO LC AS SOON AS THEY ARE IDENTIFIED. TASK COORDINATORS PROVIDE SPECIFIC DATES AND TIMES FOR LOG REQUIREMENTS WHEN AVAILABLE TO ENSURE ADEQUATE COORDINATION TIME WITH PROVIDING ACTIVITIES.

R1/COMSTASK/COMMUNICATIONS WILL BE IAW OPTASK COMMS. REF G IDENTIFIES ABBREVIATIONS TO BE USED.

V1/SAR/ALL SAR EFFORTS WILL BE CONDUCTED IAW CURRENT INSTRUCTIONS.

X1/REPINST/PROVIDING COMMANDS WILL FUND ALL COSTS OF OPERATIONS, DEPLOYMENT, AND REDEPLOYMENT. TASK COORDINATORS TRACK INCREMENTAL COSTS AND BE PREPARED TO PROVIDE COST DATA TO OSC WHEN DIRECTED. INCREMENTAL COSTS WILL BE CAPTURED IAW DOD FINANCIAL MANAGEMENT PAGE 08 RHHMHAA0028 UNCLAS

REGULATION 7000.14R, VOL 12, CHAPTER 23. PROVIDING COMMANDS WILL REPORT COST DATA THROUGH THEIR FUNDING ADMINISTRATIVE CHAIN OF COMMAND. COMNAVSURFPAC N00F, COMSUBPAC, AND COMNAVREG PEARL HARBOR HI REPORT INCREMENTAL COSTS TO CPF N80 WHEN DIRECTED. NAVSEA 00C PROVIDE CONTRACT COST DATA FOR MOBILIZATION, RIGGING AND RELOCATION PHASES TO OSC WHEN TASKED.

Y1/SPECINST/SAFETY - SAFE CONDUCT OF ALL OPERATIONS IS PARAMOUNT. AT NO POINT SHALL THE SAFETY OF PERSONNEL OR EQUIP BE COMPROMISED IN THIS OPERATION. MANNED DIVING OPERATIONS INSIDE THE EHIME MARU REQ CONSTANT ATTENTION AND DILIGENCE TO ENSURE SAFE MISSION EXECUTION.

Y2/SPECINFO/JMSDF AND JAPANESE RESEARCH VESSELS HAVE BEEN INVITED TO ASSIST IN THE RECOVERY OPERATIONS. FOLLOW INTEGRATION GUIDANCE AND DETAILS, PROMULGATED BY COMNAVSURFGRU MIDPAC SEPCOR.

Y2/SPECINFO/CULTURAL SENSITIVITY - ALWAYS CONSIDER JAPANESE NATIONAL AND CULTURAL SENSITIVITIES, AND DUE CONSIDERATION TO SURVIVORS AND FAMILY MEMBERS OF THE UNLOCATED CREWMEMBERS IN ALL ASPECTS OF THIS

**F/V EHIME MARU Recovery and Relocation Report**

MISSION. CULTURAL TRAINING IS AVAIL UPON REQUEST FOR ALL FORCES  
ASSIGNED BY CONTACTING EMCC.  
Y2/SPECINFO/ PERTINENT INFORMATION AND LINKS TO THIS RECOVERY  
OPERATION CAN BE FOUND ON THE EHIME MARU COMMAND CENTER WEBSITE AT:  
P 070300Z AUG 01 PSN 892289M38

UNCLAS

FINAL SECTION OF 02

MSGID/OPTASK/COMNAVSURFGRU MIDPAC//

SUBJ/EHIME MARU OPTASK LOGISTICS//

HTTP://WWW.CPF.NAVY.MIL

HTTP://WWW.MIDPAC.NAVY.SMIL.MIL/CC.HTM.//

BT

#0028

NNNN

## MEDICAL OPERATIONAL TASKING

Following is an excerpt from 172145Z AUG 01 date time group message from COMNAVSURFGRU MIDPAC to multiple parties regarding medical operational tasking.

SUBJ/EHIME MARU OPTASK MEDICAL//  
 RMKS/1. THIS IS A COMNAVSURGRU MIDPAC N14 OPTASK COORDINATED BY COMNAVSURFGRU MIDPAC.  
 PAGE 04 RHHMHAA0264 UNCLAS FOUO  
 A1/REF/A/APP 4(A) VOL. I  
 A1/REF/B/CINCPACFLT OPORD 001-01 DTG 151841ZJUN01  
 A1/REF/C/COMTHIRDFLT OPORD 001-01 DTG 250355ZJUN01  
 A1/REF/D/CNSGMP EHIME MARU RECOVERY CONOPS DTG 291709ZJUN01  
 A1/REF/E/CINCPACFLT EXECUTIVE ORDER 111923ZJUL01  
 A1/REF/F/COMTHIRDFLT EXECUTIVE ORDER 131733ZJUL01  
 A1/REF/G/COMNAVSURFGRU MIDPAC EHIME MARU RECOVERY OPGEN 132200ZJUL01  
 A1/REF/H/EHIME MARU RELOCATION ENVIRONMENTAL ASSESSMENT (EA)  
 A1/REF/I/CINCPACFLTINST 4740.1J (SALVAGE AND RECOVERY OPERATIONS)  
 A1/REF/J/COMNAVSEASYSOM 00C SER 0021 OF 13 APR 2001//  
 A2/PERIOD/13JUL01-15NOV01 (NOT TO EXCEED 15NOV01)//  
 A3/ADMIN/COMNAVSURFGRU MIDPAC N14 IS MEDICAL COORDINATOR  
 B1/CONDUCT/MC WILL ASSIST WITH EMERGENCY MEDICAL SUPPORT AND PROVIDE ASSISTANCE DURING TRANSFER OF RECOVERED REMAINS TO MEDICAL EXAMINER (ME), CITY AND COUNTY OF HONOLULU.  
 C2/COORD/MIDPAC HAS IN CONJUNCTION WITH MDSU-1, COMNAVREG HAWAII, USCG, AND THE HONOLULU MEDICAL EXAMINER'S OFFICE ESTABLISHED THE EMERGENCY MEDEVAC AND EM CREWMEMBERS TRANSFER PLANS FOR THE EHIME MARU RELOCATION. WHEN DIRECTED BY THE OSC, MEDICAL CELL WATCH  
 PAGE 05 RHHMHAA0264 UNCLAS FOUO  
 (MC) WILL NOTIFY REQUIRED ASSETS AND AGENCIES IOT BEGIN MEDEVAC OR EM CREWMEMBERS TRANSFER OPERATIONS. DURING THE OPERATION, MC WILL REMAIN ACCESSIBLE IOT DIRECT ALL MEDICAL ASPECTS OF THE OPERATION.//  
 D2/PREPLAN/PATIENT CARE-CIVILIAN (ROUTINE)/FOR PHASES 3,4,5,6 AND 7, CARE WILL BE PROVIDED BY SHIP'S ONSITE MEDICAL PERSONNEL. ROUTINE CONSULTATIONS CONDUCTED BY QUEENS' MEDICAL CENTER, WITH PATIENT (PT) XFER VIA SITE REQUESTED SMALL BOAT RUN. RRC WILL NOTIFY EMCC.  
 D2/PREPLAN/PATIENT CARE-CIVILIAN (EMERGENT)/FOR PHASES 3,4,5, AND 7, PT WILL BE MEDEVAC TO QUEENS' MEDICAL CENTER VIA COAST GUARD (USCG WILL RESPOND TO EMERGENCY CALL BY CIV PERS). FOR PHASE 6, MDSU-1 DIVING MEDICAL OFFICER (DMO) WILL TRIAGE EMERGENT CASES AND ARRANGE MEDEVAC, IOT TRANSPORT PT TO QUEEN'S MEDICAL CENTER. DMO WILL NOTIFY EMCC.  
 D2/PREPLAN/PATIENT CARE-JMSDF DIVERS (ROUTINE)/DURING PHASE 6, JMSDF DIVERS WILL BE TREATED BY CHIHAYA DMO. IF FURTHER CARE NEEDED, PT WILL BE TAKEN TO TRIPLER ARMY MEDICAL CENTER IN ACCORDANCE WITH SOFA.  
 D2/PREPLAN/PATIENT CARE-JMSDF DIVERS (EMERGENT)/FOR PHASE 6 PT  
 PAGE 06 RHHMHAA0264 UNCLAS FOUO  
 WILL BE TRIAGED BY CHIHAYA DMO OR MDSU-1 DMO PENDING NEAREST AVAILABLE DMO. CHIHAYA WILL BE THE PRIMARY RECOMPRESSION CHAMBER FOR DECOMPRESSION ILLNESS, MDSU-1 CHAMBER WILL BE EMERGENCY BACK UP. MDSU-1 DMO WILL ARRANGE TO MEDEVAC DIVER TO HYPERBARIC

## F/V EHIME MARU Recovery and Relocation Report

TREATMENT CENTER (AT KUAKINI HOSPITAL) IF DIVE RELATED TRAUMA WITH POSSIBLE NEED FOR RECOMPRESSION OR TRIPLER ARMY MEDICAL CENTER IF NON-RECOMPRESSION REQUIRING TRAUMA IN ACCORDANCE WITH SOFA.

D2/PREPLAN/PATIENT CARE-SRF DIVERS (ROUTINE)/ FOR PHASE 6 PT WILL BE CARED FOR BY CHIHAYA DMO. FOR FURTHER CARE PT WILL BE SENT TO TRIPLER ARMY MEDICAL CENTER. BILLING WILL BE ROUTED THROUGH CPF SURGEON'S OFFICE.

D2/PREPLAN/PATIENT CARE-SRF DIVERS (EMERGENT)/ PT WILL BE TRIAGED BY MDSU-1 DMO. TREATMENT OF DECOMPRESSION ILLNESS WILL OCCUR ON SITE IF NECESSARY OR AT MDSU-1 FLEET TREATMENT RECOMPRESSION CHAMBER AT THE DISCRETION OF MDSU-1 DMO. MEDEVAC TO HYPERBARIC TREATMENT CENTER (AT KUAKINI HOSPITAL) FOR DIVE RELATED TRAUMA THAT MAY REQUIRE RECOMPRESSION, AND MEDEVAC TO TRIPLER ARMY MEDICAL CENTER FOR NON-DIVE RELATED TRAUMA. MDSU-1 DMO WILL ARRANGE MEDEVAC AND NOTIFY RECEIVING HOSPITAL, MC AND EMCC.

D2/PREPLAN/PATIENT CARE-USN DIVERS (ROUTINE)/MEDICAL CARE WILL BE PAGE 07 RHHMHAA0264 UNCLAS FOUO PROVIDED BY MDSU-1 DMO AND HIS MEDICAL STAFF. ROUTINE CONSULTS WILL GO TO MAKALAPA CLINIC OR TRIPLER ARMY MEDICAL CENTER. DMO WILL NOTIFY MC AND EMCC.

D2/PREPLAN/PATIENT CARE-USN DIVERS (EMERGENT)/ PT WILL BE TRIAGED BY MDSU-1 DMO. TREATMENT OF DECOMPRESSION ILLNESS WILL OCCUR ON SITE OR AT MDSU-1 FLEET TREATMENT RECOMPRESSION CHAMBER (FTRC) AT THE DISCRETION OF MDSU-1 DMO. MEDEVAC TO HYPERBARIC TREATMENT CENTER (AT KUAKINI HOSPITAL) FOR DIVE RELATED TRAUMA THAT MAY REQUIRE RECOMPRESSION, AND MEDEVAC TO TRIPLER ARMY MEDICAL CENTER FOR NON RECOMPRESSION REQUIRING TRAUMA WILL BE ARRANGED FOR BY MDSU-1 DMO. MDSU-1 DMO WILL NOTIFY RECEIVING HOSPITAL, MC AND EMCC.

NOTE: THE FOLLOWING IS THE PRIMARY PLAN FOR TREATING DECOMPRESSION ILLNESS (BOTH USN AND SRF DIVERS); HOWEVER, INDIVIDUAL CASES MAY PREVENT THE USE OF THE PRIMARY PLAN. TYPE I DECOMPRESSION SICKNESS (DCS) AND NON-PROGRESSING TYPE II DCS, THE DIVER WILL BE TRANSPORTED TO MDSU-1 FTRC FOR RECOMPRESSION PROVIDED BY THE DUTY "BENDS" TEAM. MDSU-1 DMO WILL NOTIFY THE DUTY "BENDS" TEAM. RAPIDLY PROGRESSING TYPE II DCS AND ARTERIAL GAS EMBOLISM (AGE) WILL BE TREATED IMMEDIATELY ON THE DIVE SIDE. MDSU-1 DMO WILL NOTIFY THE MC AND EMCC, PREPARE ASSOCIATED MISHAP MESSAGES, NOTIFY THE DUTY "BENDS" PAGE 08 RHHMHAA0264 UNCLAS FOUO

TEAM IF FOLLOW UP TREATMENTS ARE NECESSARY AND TRANSPORT TO FTRC AS APPROPRIATE. TRAUMA PT WITH POSSIBLE NEED FOR RECOMPRESSION WILL BE MEDEVACED TO HYPERBARIC TREATMENT CENTER (AT KUAKINI HOSPITAL), IF THE PATIENTS CONDITION IS STABLE. TRAUMA THAT DOES NOT REQUIRE RECOMPRESSION WILL BE MEDEVACED TO TRIPLER ARMY MEDICAL CENTER.

D2/PREPLAN/EM CREWMEMBERS RECOVERY/DEEP WATER/ RRC OR NAVSEA (SUPSALV) REP WILL NOTIFY EMCC THAT EM CREWMEMBERS HAVE BEEN FOUND. EMCC WILL NOTIFY CHIEF OF STAFF, MC, SECURITY COORDINATOR, AND TWR CREW TO STANDBY FOR TRANSPORT OF ME AND MC REP TO DEEP WATER SITE. MC WILL NOTIFY ME'S OFFICE TO SEND MEDICAL EXAMINERS CHIEF INVESTIGATOR (MECI). MC REP AND MECI WILL GO TO RW2 AND HANDLE EM CREWMEMBERS TRANSFER VIA TWR. MC WILL BRING NECESSARY BODY BAGS AND OSHA PROTECTIVE EQUIPMENT TO THE DEEP WATER SITE.

D2/PREPLAN/EM CREWMEMBERS RECOVERY/SHALLOW WATER/ WHEN TWR IS SET TO TRANSPORT MECI AT THE END OF THE DAY, MECI WILL CALL ME'S OFFICE TO SEND VANS TO PICK UP EM CREWMEMBERS AT TWR BOATDOCK. ONSITE MEDICAL SHOULD NOTIFY WATCH OFFICER THAT EM CREWMEMBERS HAVE BEEN FOUND. WATCH OFFICER WILL NOTIFY CHIEF OF STAFF, SECURITY AND MC REPRESENTATIVES ABOUT EM CREWMEMBERS.



F/V EHIME MARU Recovery and Relocation Report

E1/PLAN/1/DEEP WATER RECOVERY OPERATIONS PRIOR TO LIFTING OF EHIME  
P 172145Z AUG 01 ZYB PSN 997173M36

UNCLAS FOUO//N03120//

SECTION 02 OF 04

OPER/EHIME MARU RECOVERY OPERATIONS//

MSGID/OPTASK/COMNAVSURFGRU MIDPAC/001/JUL //

SUBJ/EHIME MARU OPTASK MEDICAL//

MARU/EM CREWMEMBERS FOUND AT THE DEEP WATER SITE WILL BE PICKED UP BY ROV AND PLACED IN RECOVERY BASKET (LINED WITH MESH IOT PREVENT PARTICULATE MATTER FROM ESCAPING, BUT ALLOWING WATER TO DRAIN) FOR LATER TRANSPORT TO THE SURFACE. BASKET WILL HAVE CLAMSHELL LID, WHICH WILL REMAIN CLOSED UNTIL BASKET IS BROUGHT BACK ONTO RW2. BASKET WILL REMAIN ON THE BOTTOM UNTIL ME'S INVESTIGATOR AND MC CREW ARRIVES. EM CREWMEMBERS WILL BE TRANSFERRED (STILL WITHIN MESH LINING) BY MC CREW TO GREEN BODY BAG AND THEN TO OSHA STANDARD BIOHAZARD BAG. MECI WILL BE ONSITE DURING TRANSFER AND WILL HAVE CUSTODY OF EM CREWMEMBERS. EM CREWMEMBERS WILL BE PLACED IN A STOKES' STRETCHER AND TRANSFERRED TO WAITING TWR TO BE TRANSPORTED TO THE TWR BOATHOUSE. TRANSFER OF EM CREWMEMBERS FROM RW2 WILL OCCUR USING TWR BROW EXTENDED TO MAIN DECK OF RW2. STRETCHERS WILL THEN BE HAND CARRIED OVER THE BROW FROM THE MAIN DECK TO THE FLYING BRIDGE DECK OF THE TWR WHERE TWR CREWMEMBERS WILL BE WAITING TO RECEIVE STRETCHERS. STRETCHERS WILL THEN BE LOWERED DOWN TO THE MAIN DECK OF THE TWR AND SECURED DIRECTLY ONTO THE MAIN DECK. WHITE SHEETS WILL BE PLACED OVER EM CREWMEMBERS. MECI AND MEDICAL CELL REPS WILL EMBARK BACK ONTO TWR VIA BROW. TARP WILL BE DRAWN TO PREVENT VISUALIZATION OF EM CREWMEMBERS. TWR WILL RETURN TO BOATHOUSE FOR TRANSFER TO ME'S VANS.

E1/PLAN/2/DEEP WATER RECOVERY OPERATIONS DURING LIFT AND TRANSIT OF  
PAGE 05 RHHMHAA0265 UNCLAS FOUO

EHIME MARU TO SHALLOW WATER SITE/IF EM CREWMEMBERS ARE FOUND TO ESCAPE WHILE EHIME MARU IS BEING TRANSPORTED TO SHALLOW WATER SITE, ROV FOLLOWING VESSEL WILL PICK UP EM CREWMEMBERS. A RECOVERY BASKET FROM SALVOR WILL BE LOWERED AND ROV WILL PLACE EM CREWMEMBERS IN THIS STEEL MESH LINED SALVAGE BASKET. EM CREWMEMBERS WILL BE BROUGHT TO SURFACE AND MEDICAL CREW OF USS SALVOR WILL TRANSFER EM CREWMEMBERS FROM SALVAGE BASKET TO MESH BODY BAG, THEN GREEN BODY BAG, THEN OSHA STANDARD BIOHAZARD BAG. MECI WILL BE ON SITE ALONG WITH MEDICAL CELL REP TO ASSIST WITH EM CREWMEMBERS HANDLING AND CUSTODY. EM CREWMEMBERS WILL BE PLACED ON STOKES' STRETCHER AND TRANSFERRED TO WAITING TWR TO BE TRANSPORTED TO TWR BOATHOUSE WHERE ME'S VANS WILL BE WAITING. TRANSFER OF EM CREWMEMBERS FROM SALVOR TO TWR WILL OCCUR UTILIZING A BROW THAT WILL BE EXTENDED FROM THE TWR TO THE FANTAIL OF SALVOR. AFTER EM CREWMEMBERS ARE PLACED IN A STOKES STRETCHER THEY WILL BE HAND CARRIED ACROSS THE BROW TO TWR CREWMEMBERS ON THE FLYING BRIDGE. STRETCHER WILL THEN BE LOWERED DOWN TO CREWMEMBERS STANDING ON THE MAIN DECK AND THEN SECURED DIRECTLY ONTO THE MAIN DECK. WHITE SHEETS WILL BE PLACED OVER THE EM CREWMEMBERS. A TARP WILL BE DRAWN TO PREVENT VISUALIZATION FROM ABOVE. MECI WILL BOARD TWR AND ESCORT EM CREWMEMBERS BACK TO TWR  
PAGE 06 RHHMHAA0265 UNCLAS FOUO  
BOATHOUSE.

E1/PLAN/3/SHALLOW WATER RECOVERY OPERATIONS/DIVING OPERATIONS  
COORDINATOR (DOC) WILL DIRECT DIVERS, WHILE UNDERWATER, TO PLACE THE EM CREWMEMBERS FOUND IN A MESH BAG, THEN TRANSFER EM CREWMEMBERS INTO A STANDARD GREEN BODY BAG WHICH WILL HAVE HOLES CUT SO WATER CAN

## F/V EHIME MARU Recovery and Relocation Report

DRAIN OUT OF BAG FOR EASE OF HANDLING AS EM CREWMEMBERS ARE BROUGHT TO THE SURFACE. EM CREWMEMBERS WILL BE TRANSFERRED TO A RECOVERY BASKET. BASKET WILL REMAIN ON OCEAN FLOOR UNTIL DIVING IS COMPLETED FOR THE DAY AND WILL BE BROUGHT TO THE SURFACE FOR TRANSFER TO THE TWR.

E1/PLAN/4/EM CREWMEMBERS TRANSFER PROCESS/PLAN USED WILL DEPEND ON SITUATIONAL STATUS AT TIME OF EM CREWMEMBERS TRANSFER IE: SEA STATE AND SAFETY CONCERNS. ONCE ON SITE, TWR CRAFTMASTER WILL DETERMINE THE SAFEST TRANSFER METHOD AFTER SITUATIONAL ASSESSEMENT. IF SEAS ARE TOO HIGH AND THEREFORE POSE A SAFETY RISK, EM CREWMEMBERS TRANSFER WILL BE DELAYED UNTIL IT IS DEEMED SAFE TO PROCEED WITH TRANSFER. IF THIS IS THE CASE EM CREWMEMBERS WILL BE STORED IN A REEFER UNIT UNTIL IT IS SAFE TO PROCEED. OPTION 1: TWR TO COME ALONG PORT SIDE OF BARGE WHERE ACCOM LADDER IS LOCATED AND ALLOW MECI, MDSU-1 MEDICAL TEAM, AND COMBAT CAMERAMAN TO BOARD TWR. THE TWR WILL THEN MOVE TO THE  
PAGE 07 RHHMHAA0265 UNCLAS FOUO

STARBOARD SIDE OF THE BARGE AND MOOR TWR ALONGSIDE CROWLEY BARGE. ONCE SECURED TO THE BARGE THE CRANE WILL BRING RECOVERY BASKET FROM OCEAN FLOOR AND PLACE BASKET DIRECTLY ON THE AFT END OF THE MAIN DECK OF THE TWR. THE SMALLER RECOVERY BASKETS (4FT X 4FT X 8FT) WILL BE USED FOR EM CREWMEMBERS TRANSFER. EM CREWMEMBERS WILL BE REMOVED FROM BASKET AND PLACED IN OSHA STANDARD BIOHAZARD BAG AND THEN SEALED, TAGGED, AND PLACED IN STOKES STRETCHER AND SECURED DIRECTLY ONTO THE MAIN DECK. WHITE SHEETS WILL THEN BE PLACED OVER EM CREWMEMBERS. TARPS WILL BE DRAWN AND SECURED TO THE MAIN DECK TO PREVENT VISUALIZATION FROM ABOVE. MECI WILL ASSUME CUSTODY OF EM CREWMEMBERS AND ESCORT EM CREWMEMBERS BACK TO THE TWR BOATHOUSE. ONCE STOKES STRETHCER WITH EM CREWMEMBERS ARE SECURED TO THE DECK, THE TWR WILL RETURN TO THE PORT SIDE OF THE BARGE AND DISEMBARK THE MDSU-1 MEDICAL TEAM AND EMBARK REMAINING PASSENGERS FROM BARGE AT THE END OF THE DAY. TWR WILL THEN RETURN TO THE BOATHOUSE. OPTION 2: IF SEAS ARE TOO ROUGH ON THE DAY EM CREWMEMBERS ARE FOUND TO PERMIT DIRECT TRANSFER ONTO TWR, THE RECOVERY BASKET WILL BE BROUGHT UP AND CRANED ONTO THE CROWLEY BARGE. AT THIS TIME THE EM CREWMEMBERS WILL BE TAKEN FROM THE BASKET, PLACED INTO OSHA STANDARD BIOHAZARD BAGS AND THEN ONTO STOKES STRETCHERS. A WHITE  
PAGE 08 RHHMHAA0265 UNCLAS FOUO

SHEET WILL BE PLACED OVER EACH SET OF EM CREWMEMBERS. THE EM CREWMEMBERS WILL THEN BE PLACED INTO A STORAGE REEFER UNTIL WEATHER PERMITS A SAFE TRANSFER TO THE TWR. WHEN IT IS DEEMED SAFE FOR TRANSFER, THE BROW FROM THE TWR WILL BE EXTENDED ACROSS TO THE MAIN DECK OF THE BARGE. CREWMEMBERS FROM THE BARGE WILL HAND CARRY STOKES STRETCHER ACROSS THEBROW TO WAITING TWR CREWMEMBERS STANDING ON THE FLYING DECK. TWR CREWMEMBERS WILL PASS STOKES STRETCHER TO TWR CREWMEMBERS ON THE MAIN DECK WHERE THE STRETCHERS WOULD THEN BE SECURED. TARP WILL THEN BE DRAWN AND SECURED TO THE MAIN DECK TO PREVENT VISUALIZATION FROM ABOVE. MECI WILL PRECEDE EM CREWMEMBERS ONTO TWR AND WILL ASSUME CUSTODY OF EM CREWMEMBERS WHEN THEY ARE TRANSFERRED ABOARD AND WILL ESCORT EM CREWMEMBERS BACK TO TWR BOATHOUSE. UPON RETURN TO THE TWR BOATHOUSE, STOKES STRETCHERS WILL BE PASSED FROM TWRCREWMEMBERS ON MAIN DECK TO CREWMEMBERS WAITING ON THE FINGER PIER. STOKES STRETCHER WILL BE CARRIED TO TWR BOATHOUSE WHERE ME'S VANS WILL BE WAITING. TWR BOATHOUSE WILL BE SECURED ONCE ALL STRETCHERS ARE INSIDE AND TRANSFER WILL OCCUR TO GURNEYS AND INTO VANS. E1/PLAN/5/LOGISTICS COORDINATION/THE TWR WILL TRANSPORT THE EM CREWMEMBERS AND THE MECI FROM THE CROWLEY BARGE TO THE TWR LANDING. WHENEVER POSSIBLE, THIS WILL BE DONE AT NIGHT. THERE WILL

F/V EHIME MARU Recovery and Relocation Report

P 172145Z AUG 01 ZYB PSN 997170M33

UNCLAS FOUO//N03120//

SECTION 03 OF 04

OPER/EHIME MARU RECOVERY OPERATIONS//

MSGID/OPTASK/COMNAVSURFGRU MIDPAC/001/JUL //

SUBJ/EHIME MARU OPTASK MEDICAL//

BE A COVER ON THE TWR TO CONCEAL THE EM CREWMEMBERS FROM VIEW. THE TWR WILL TRANSPORT MECI AND MC REPS TO DEEP WATER SITE FOR EM  
PAGE 04 RHHMHAA0266 UNCLAS FOUO

CREWMEMBERS HANDLING WHENEVER REQUIRED. TWR WILL TRANSPORT MECI TO SALVOR THE DAY OF LIFTING IF REQUIRED IN PREPARATION FOR THE POSSIBILITY THAT EM CREWMEMBERS ARE FOUND. TWR SHOULD STANDBY TO TRANSPORT EM CREWMEMBERS, MECI AND MC REPS BACK TO TWR BOATDOCK ON SHORT NOTICE DURING RECOVERY OPERATION. DURING PHASE 6, DMO WILL NOTIFY EMCC THAT EM CREWMEMBERS HAVE BEEN RECOVERED AS SOON AS POSSIBLE. EMCC WILL IN TURN NOTIFY THE CHIEF OF STAFF AND THE TWR CREW TO BE STANDING BY TO TRANSIT TO BARGE IOT ASSIST IN EM CREWMEMBERS TRANSPORT ASHORE. IF MORE THAN 3 SETS OF EM CREWMEMBERS ARE RECOVERED IN ONE DAY, THE DMO WILL NOTIFY EMCC. EMCC WILL NOTIFY COS, WR BOATHOUSE, AND MC. TWR WILL NEED TO PREPARE FOR IMMEDIATE TRANSIT TO THE BARGE IN ORDER TO ASSIST WITH EM CREWMEMBERS TRANSPORT ASHORE. EMCC TWR CREW WILL ASSIST ME'S STAFF AND MEDICAL CELL WITH TRANSFERRING EM CREWMEMBERS FROM VESSEL TO TWR, FROM TWR ASHORE, AND FROM STOKES STRETCHER TO GURNEYS ONCE ASHORE. TRANSFER TO ME'S VANS WILL OCCUR WITHIN TWR BOATHOUSE WHERE ME'S VANS WILL BE WAITING. DOOR TO BOATHOUSE WILL BE CLOSED DURING TRANSFER OF EM CREWMEMBERS. ALL WINDOWS OF TWR BOATHOUSE WILL BE COVERED TO CONCEAL TRANSFER FROM OUTSIDE VIEW. UPON COMPLETION OF TRANSFER, MC WILL NOTIFY EMCC, AND  
PAGE 05 RHHMHAA0266 UNCLAS FOUO

EMCC WILL NOTIFY COS. REQUEST ISSUE THREE NEXTEL CELL PHONES TO BE ISSUED TO THE TWO ASSISTANT MC, AND THE DMLCPO.

E1/PLAN/6/SECURITY COORDINATION/MC PROVIDED LIST OF MEDICAL SUPPORT PERS THAT WILL REQUIRE ACCESS TO THE CROWLEY BARGE DURING PHASE 6. SECURITY COORDINATOR WILL ENSURE DAILY ACCESS FOR THE MC MEMBERS AND THE MECI TO THE BARGE THROUGHOUT PHASE 6 OF EM CREWMEMBERS RECOVERY. SECURITY COORDINATOR WILL ENSURE HONOLULU MEDICAL EXAMINER AND HER TRANSPORT VANS HAVE ACCESS TO THE BASE AND TWR BOATDOCK WHEN ISO EM CREWMEMBERS RECOVERY. SECURITY AROUND TWR BOATDOCK IS PARAMOUNT DURING TRANSFER OF EM CREWMEMBERS FROM TWR ONTO GURNEYS, AND THEN INTO THE ME'S VANS. COORDINATE ESCORT FOR VANS OFF BASE AS REQUIRED.

E1/PLAN/7/RIGGING AND RECOVERY COORDINATION/RRC WILL PROVIDE POC INFO FOR ALL HEALTH AND SAFETY OFFICIALS FOR EACH CONTRACTED VESSEL. MC WILL COORDINATE WITH QUEENS MEDICAL CENTER ISO CIVILIAN HEALTH CARE AS REQUIRED. NOTIFY EMCC.E2/READINESS/IN EVENT THAT INCLEMENT WEATHER RESTRICTS MEDEVAC HELOS FROM FLYING, MEDEVACS SHOULD BE CONDUCTED USING THE NEXT SAFEST METHOD (TUG,RHIB, ETC.). EMCC WILL BE REQUIRED TO ASSIST BACK UP MEDEVAC COORDINATION. PORT OPS AND TWR CREW WILL BE IN SHORT NOTICE STANDBY ISO BACKUP MEDEVAC  
PAGE 06 RHHMHAA0266 UNCLAS FOUO  
ACTION.

F1/ASSET/HONOLULU MECI WILL TRANSFER TO THE CROWLEY BARGE DAILY. MECI WILL OBSERVE RECOVERY OPERATIONS ON CLOSED CIRCUIT MONITOR ONBOARD BARGE, AND DOCUMENT PROCESS. MECI WILL ASSUME CUSTODY OF EM CREWMEMBERS WHEN THEY ARE EMOVED FROM THE WATER AND RETURN TO PORT ISO EM CREWMEMBERS TRANSFER. MECI WILL ALSO BE PRESENT TO

## F/V EHIME MARU Recovery and Relocation Report

DOCUMENT AND ASSIST WITH EM CREWMEMBERS HANDLING IF EM CREWMEMBERS ARE DISCOVERED WHEN EHIME MARU IS LIFTED FROM OCEAN FLOOR DURING DEEP WATER PHASE. SHE WILL THEN ASSUME CUSTODY OF EM CREWMEMBERS ONCE EM CREWMEMBERS ARE BROUGHT TO SURFACE.

Q1/LOGISTIC/1/REQUEST CELL PHONES ISSUED TO ASSISTANT MC AND MDSU-1 DMLCPO (2 TOTAL). COORDINATE FUNDING OF US ARMY CENTRAL IDENTIFICATION LABORATORY HAWAII IN EVENT DNA TESTING IS REQUIRED FOR IDENTIFICATION OF EM CREWMEMBERS. COORDINATE ICW EMCC WATERBORNE TRANSPORTATION FROM DEEP-WATER SITE TO SHORE FOR ROUTINE PATIENT CONSULTS AS NEEDED.

R1/COMSTASK/1/PATIENTS REQUIRING EMERGENT MEDEVAC CALL 541-2450 (COAST GUARD GROUP HONOLULU) OR BRIDGE TO BRIDGE CH. 16. APPROX RESPONSE TIMES: HELO - DEEP WATER 25 MINS, SHALLOW WATER 20 MINS; SURFACE SHIP - DEEP WATER 45 MINS, SHALLOW WATER 15 MINS. AFTER PAGE 07 RHHMHAA0266 UNCLAS FOUO CALLING FOR MEDEVAC, NOTIFY EMCC AND CONTACT THE MC AT 864-0568, 306-2469 OR, 577-2566, OR 479-9705. NOTIFY THE MC AND THE EMCC FOR ALL PATIENT TRANSFERS. IF MC CANNOT BE REACHED, NOTIFY ONE OF THE ASSISTANTMC. ALL OTHER COMMUNICATIONS WILL BE IAW OPTASK COMMS. REF G IDENTIFIES ABBREVIATIONS TO BE USED.

V1/SAR/ALL SAR EFFORTS WILL BE CONDUCTED IAW CURRENT INSTRUCTIONS.

X1/REPINST/1/MEDICAL CELL POCs ARE: LT CLARK-CELL LEADER- CELL 864-0568, PAGER 549-8609, HMCM KUNZ CELL 306-2469, PAGER 574-3571, HMC FLORENDO PAGER 577-2566, HMC REXROAD CELL-479-9705, PAGER 363-3794.

X1/REPINST/2/UNRESTRICTED VOICE RPTS WILL BE MADE VIA BRIDGE TO BRIDGE RADIO (CHANNEL 16 OR 23) AND CELLULAR PHONE TO EMCC WATCH OFFICER. RPTS SENSITIVE IN NATURE WILL BE PROVIDED VIA INMARSAT PHONE OR VIA COMMERCIAL VHF SECURE HAND HELD RADIO TO EMCC WATCH OFFICER. DATA REPORTS WILL BE PROVIDED TO EMCC WATCH OFFICER VIA INMARSAT FAX OR E-MAIL.

EMCC WATCH OFFICER: (808) 473-0599/1277  
EMCC FAX: (808) 473-0612  
EMCC E-MAIL: EMCC(AT)MIDPAC.NAVY.MIL//

X1/REPINST/3/COMMENCING 13JUL01, COMNAVSURFGRU MIDPAC WILL TRANSMIT PAGE 08 RHHMHAA0266 UNCLAS FOUO DAILY SITREP TO CINCPACFLT NLT 2000Z (1000 HST). STARTING 24 HOURS PRIOR TO THE LIFT OF EHIME MARU FOR RELOCATION TO SWRS, THE SITREP WILL BE PROVIDED TWICE DAILY NLT 0700Z (2100 HST) AND 2000Z (1000 HST). WHEN CONDUCTING OPERATIONS, RRC WILL SUBMIT SITREP INPUTS TO EMCC VIA E-MAIL (PRI) OR VOICE (ALT) NLT ONE HOUR PRIOR TO THE ABOVE DUE TIMES. ANY ADDITIONAL REPORTABLE INCIDENTS WILL BE REPORTED IAW STANDARD NAVAL REPORTING PROCEDURES.

X1/REPINST/4/RRC WILL COORDINATE DOCUMENTATION OF ALL EVENTS DURING RIGGING AND RELOCATION AND WILL PROVIDE FINAL REPORT INPUTS TO OSC UPON THE COMPLETION OF EM CREWMEMBERS RECOVERY AND FINAL VESSEL RELOCATION. WILL USE NAVSEAINST 4740.8A AS GUIDANCE. ALL RRC ASSIGNED SUPPORT ORGANIZATIONS SUBMIT LESSONS LEARNED IN NLL FORMAT TO RRC UPON COMPLETION OF MISSION IOT FORWARD FINAL LESSONS LEARNED TO COMNAVSURFGRU MIDPAC ASAP.//

Y1/SPECINST/SAFETY - SAFE CONDUCT OF ALL OPERATIONS IS PARAMOUNT. AT NO POINT SHALL THE SAFETY OF PERSONNEL OR EQUIP BE COMPROMISED IN THIS OPERATION. MANNED DIVING OPERATIONS INSIDE THE EHIME MARU REQ CONSTANT ATTENTION AND DILIGENCE TO ENSURE SAFE MISSION EXECUTION. Y1/SPECINST/RRC COORDINATE ALL PUBLIC AFFAIRS MATTERS WITH CINCPACFLT PAO. THE PUBLIC AFFAIRS APPROACH TO THIS DEPLOYMENT

P 172145Z AUG 01 ZYB PSN 997172M35

UNCLAS FOUO//N03120//  
FINAL SECTION OF 04  
OPER/EHIME MARU RECOVERY OPERATIONS//  
MSGID/OPTASK/COMNAVSURFGRU MIDPAC/001/JUL //  
SUBJ/EHIME MARU OPTASK MEDICAL//  
IS ACTIVE. CINCPACFLT PA HAS BEEN COORDINATING WITH ALL AGENCIES  
INVOLVED. RRC WILL COORDINATE ALL REQUESTS FROM THE MEDIA WITH  
PAGE 04 RHHMHAA0267 UNCLAS FOUO  
CINCPACFLT PUBLIC AFFAIRS REP FOR THIS OPERATION, MR. JON  
YOSHISHIGE, (808)471-3769, DSN 315 471-3769.  
EMAIL YOSHISJ@CPF.NAVY.MIL.  
FOR ADDITIONAL MEDIA COORDINATION GUIDANCE, REFER TO REF G AND THE  
EHIME MARU OPTASK PUBLIC AFFAIRS.  
Y2/SPECINFO/JMSDF AND JAPANESE RESEARCH VESSELS HAVE BEEN INVITED TO  
ASSIST IN THE RECOVERY OPERATIONS. FOLLOW INTEGRATION GUIDANCE AND  
DETAILS, PROMULGATED BY COMNAVSURFGRU MIDPAC SEPCOR.  
Y2/SPECINFO/CULTURAL SENSITIVITY - ALWAYS CONSIDER JAPANESE NATIONAL  
AND CULTURAL SENSITIVITIES, AND DUE CONSIDERATION TO SURVIVORS AND  
FAMILY MEMBERS OF THE UNLOCATED EM CREWMEMBERS IN ALL ASPECTS OF  
THIS MISSION. CULTURAL TRAINING IS AVAIL UPON REQUEST FOR ALL  
FORCES ASSIGNED BY CONTACTING THE OSC.  
Y2/SPECINFO/ PERTINENT INFORMATION AND LINKS TO THIS RECOVERY  
OPERATION CAN BE FOUND ON THE EHIME MARU COMMAND CENTER WEBSITE  
AT: [HTTP://WWW.MIDPAC.NAVY.MIL/CC](http://WWW.MIDPAC.NAVY.MIL/CC) AND  
[HTTP://WWW.MIDPAC.NAVY.SMIL.MIL/CC.HTM](http://WWW.MIDPAC.NAVY.SMIL.MIL/CC.HTM) //  
BT  
#0264

# OIL SPILL MESSAGE

## OCT 17, 02

Following is a representative message of a small oil spill that occurred on during the relocation and recovery phase of the operations.

PATUZYUW RHHMHAA0062 2890740-UUUU--RULSSEA.  
ZNR UUUUU ZUI RHHMNCB4399 2890748  
P 160730Z OCT 01 PSN 535792M31  
FM COMNAVSURFGRU MIDPAC//N01//  
TO RUHEMCQ/COMNAVREG PEARL HARBOR HI//N00/N01/N52//  
INFO RHMFIUU/CNO WASHINGTON DC//N45//  
RUENAAA/CNO WASHINGTON DC//N45//  
RHHMUNA/USCINCPAC HONOLULU HI//J44//  
RHHMHAA/CINCPACFLT PEARL HARBOR HI//N43//N46//  
RHHMHBA/CINCPACFLT PEARL HARBOR HI//N43//N46//  
RHMFIUU/CHINFO WASHINGTON DC//JJJ//  
RUENAAA/CHINFO WASHINGTON DC//JJJ//  
RULSSEA/COMNAVSEASYS COM WASHINGTON DC//00C//  
RHMFIUU/NFESC PORT HUENEME CA//424//  
RUWFPCN/NFESC PORT HUENEME CA//424//  
RUEADLA/NAVPEOFF ALEXANDRIA VA//JJJ//  
RUWDQAA/COGARD MSO HONOLULU HI  
RULSJGA/COGARD NATIONAL RESPONSE CENTER WASHINGTON DC//JJJ//  
RUHEMDQ/COMNAVSURFGRU MIDPAC//N01//  
BT  
UNCLAS//NO5090//  
SUBJ/OIL SPILL REPORT, 247 GALLONS, EHIME MARU RECOVERY OPERATION,  
PAGE 02 RHHMHAA0062 UNCLAS//NO5090//  
LIFT AND RELOCATION PHASE//  
MSGID/GENADMIN/EHIME MARU COMMAND CENTER//  
RMKS/1. THIS OIL SPILL MESSAGE COVERS THE PERIOD OF LIFT AND  
RELOCATION OPERATIONS FROM 12OCT01 TO 15OCT01.  
2. ACTIVITY/SHIP ORIGINATING RELEASES: JAPANESE FISHING VESSEL  
EHIME MARU.  
3. SPILL LOCATION: ALONG TRANSIT ROUTE FROM 21-4.8N5, 157-49.5W1  
(9 MI FROM NEAREST LAND) TO 21-17.32N, 157-56.16W (0.75 MI. FROM  
SHORE)  
4. VOLUME SPILLED IN GALLONS: EST 197-247 GALLONS FOR PERIOD 12OCT TO  
15OCT01.  
5. TYPE OF OIL SPILLED: DIESEL FUEL MARINE (DFM), TESORO.  
6. OPERATION UNDER WAY WHEN SPILL OCCURRED: LIFT AND RELOCATION PHASE  
OF EHIME MARU RECOVERY OPERATION.  
7. SPILL CAUSE: PRESSURE DURING FALL TO OCEAN FLOOR COLLAPSED  
STRUCTURE AND FUEL TANKS. MOVEMENT OF VESSEL DURING LIFT AND  
RELOCATION OPERATIONS TRIGGERED SLOW LEAKAGE OF DIESEL FUEL.  
8. SLICK DESCRIPTION AND MOVEMENT: INTERMITTENT LIGHT OIL SHEENS  
OBSERVED 12-13OCT01 BY SCHEDULED USCG AND NAVY COMMERCIAL  
OVERFLIGHTS. SHEEN MOVED TO THE SOUTHEAST, IN THE DIRECTION OF  
PAGE 03 RHHMHAA0062 UNCLAS//NO5090//  
PREVAILING WINDS. RAINBOW OIL SHEEN OBSERVED 14-15OCT01 BY  
SCHEDULED NAVY COMMERCIAL OVERFLIGHT AND USCG. SHEEN MOVED TO THE  
SOUTH, IN THE DIRECTION OF PREVAILING CURRENTS.  
9. SPILL ENVIRONMENT: WEATHER VARIABLE DURING REPORTING PERIOD.  
10. AREAS DAMAGED OR THREATENED: THREATENED AREA: KEEHI LAGOON, HI.

**F/V EHIME MARU Recovery and Relocation Report**

NO AREAS DAMAGED.

11. TELEPHONIC REPORT TO NATIONAL RESPONSE CENTER WAS MADE 0747W 12OCT01, NRC CASE NUMBER 582813. REPORT TAKEN BY MR. VANTRAN. NAVY COMMAND MAKING REPORT: COMNAVSURFGRU MIDPAC.

12. CONTAINMENT METHOD PLANNED/USED: VISUAL OBSERVATIONS NOTED. NAVY SKIMMERS AND CLEAN ISLANDS COUNCIL (CIC) OSRV DEPLOYED TO CONTAIN, ABSORB AND DISSIPATE OILY SHEEN.

13. SPILL REMOVAL METHOD PLANNED/USED: NAVY SKIMMERS AND CIC OSRV USED TO ABSORB, CONTAIN AND DISSIPATE OILY SHEEN.

14. PARTIES PERFORMING SPILL REMOVAL: NAVY SUPSALV AND CLEAN ISLANDS COUNCIL.

15. ASSISTANCE REQUIRED/ADDITIONAL COMMENTS: EHIME MARU RECOVERY OPERATION, SHALLOW WATER RECOVERY PHASE TO FOLLOW IMMEDIATELY. SPILL RESPONSE PREPARATION, AS OUTLINED IN THE ENVIRONMENTAL ASSESSMENT AND INCIDENT ACTION PLAN FOR THIS PHASE, WILL BE PAGE 04 RHHMHAA0062 UNCLAS//NO5090// IMPLEMENTED.

16. STATE AND LOCAL CORRECTIVE ACTION TAKEN: USCG MSO HONOLULU (FOSC) AND STATE DEPARTEMENT OF HEALTH (SOSC) PARTICIPATED IN UNIFIED COMMAND DURING LIFT AND RELOCATE PHASE.//

BT

#0062

NNNN

**This page was intentionally left blank.**



## *Appendix F*

# Contact Information

### **C & C Technologies, Inc.**

P.O. Box 1137  
Apex, NC 27502  
Telephone: (919) 362-1116  
Telephone: (866) 938-3782  
Web site: [www.cctechnol.com](http://www.cctechnol.com)  
Provided subsurface navigation system.

### **Canyon Offshore:** North and South America (Headquarters)

5212 Brittmoore Rd.  
Houston, TX 77041  
Telephone: (713) 856-6010  
Fax: (713) 856-6020  
Web site: [www.canyonrov.com](http://www.canyonrov.com)  
Provided work class ROV systems.

### **Jet Research Center**

5429 Highway 90 East  
Broussard, LA 70518  
Telephone: (337) 837-2681  
Fax: (337) 837-2545  
Provided explosive cutters.

### **Clean Islands Council**

179 Sand Islands Access Rd.  
Honolulu, HI 96819  
Telephone: (808) 845-8465  
Fax: (808) 845-8457  
E-mail: [kimb@cleanislands.com](mailto:kimb@cleanislands.com)  
Web site: [www.cleanislands.com](http://www.cleanislands.com)  
Provided environmental services.

### **Crowley Marine Services, Seattle**

1102 SW Massachusetts  
Seattle, WA 98134

## **F/V EHIME MARU Recovery and Relocation Report**

Telephone: (206) 332-8000

Fax: (206) 332 8305

Web site: [www.crowley.com](http://www.crowley.com)

Other Web sites: [www.marine-salvage.com/companypages/crowley.htm](http://www.marine-salvage.com/companypages/crowley.htm)

Prime West Coast salvage contractor for SUPSALV. Provided transportation, support platform and heavy lift during the final phase.

### **Cudd Pressure Control Inc.**

4544 Post Oak Place, Suite 280

Houston, TX 77027

Telephone: (713) 877-1118

Telephone: (800) 990-CUDD

Fax: (713) 877-8961

E-mail: [cpcinfo@cudd.com](mailto:cpcinfo@cudd.com)

Web site: [www.cuddpressurecntrl.com](http://www.cuddpressurecntrl.com)

Provided the coil tube drilling system.

### **GPC, Inc (now PCCI, Inc)**

300 North Lee Street, Suite 201

Alexandria, VA 22314

Telephone: (703) 684-2060

Fax: (703) 684-5343

Web site: [www.pccii.com/](http://www.pccii.com/)

Prime contractor to SUPSALV for maintenance and operation of the ESSM system and oil spill cleanup and environmental issues. Provided environmental contingency planning, oil spill recovery systems, personnel and facilities for the command center.

### **Halliburton Subsea**

4100 Clinton Drive

Houston, TX 77020

E-mail: [locations@halliburton.com](mailto:locations@halliburton.com)

Web site: [www.halliburton.com](http://www.halliburton.com)

Provided the ROCKWATER 2 under contract to SMIT.

### **Huisman-ITREC**

Admiraal Trompstraat 2 - 3115 HH Schiedam

P.O. Box 150 - 3004 AD Schiedam

The Netherlands

Harbour no. 561

Telephone: 0031 (0) 10 245 22 22

Fax: 0031 (0) 10 245 22 20

E-mail: [mail@huisman-itrec.com](mailto:mail@huisman-itrec.com)

Web site: [www.huisman-itrec.com](http://www.huisman-itrec.com)

Provided the linear winches installed on ROCKWATER 2.

**Keppel Corporation**

Group Corporate Communications

23 Church Street

#15-01 Capital Square

Singapore 049481

Telephone: 65 6270 6666

Fax: 65 6885 7452

E-mail: [keppelgroup@kepcorp.com](mailto:keppelgroup@kepcorp.com)

Web site: [www.kepcorp.com](http://www.kepcorp.com)

Provided manufacturing and assembly of heavy salvage material for SMIT.

**Oceaneering International**

Corporate Headquarters

11911 FM 529

Houston, TX 77041

Telephone: (713) 329-4500

Fax: (713) 329-4951

Web site: [www.oceaneering.com](http://www.oceaneering.com)

Prime ROV operator for SUPSALV DEEP DRONE and SWISS during initial survey phase.

**Phoenix International**

6340 Columbia Park Rd., Suite A

Landover, MD 20785

Telephone: (800) 648-8949

Telephone: (301) 341-7800

Fax: (301) 341-9465

E-mail: [tjanaitis@phnx-international.com](mailto:tjanaitis@phnx-international.com)

Web site: [www.phnx-international.com](http://www.phnx-international.com)

Prime contractor for ROV operations and maintenance of the SUPSALV DEEP DRONE and SWISS during the final phases of the project.

**ROH, Inc.**

1220 Twelfth Street, S.E.

Maritime Plaza II, Suite 060

Washington, DC 20003

Telephone: (202) 459-6000

## **F/V EHIME MARU Recovery and Relocation Report**

Fax: (202) 459-6019

Web site: [www.roh-inc.com](http://www.roh-inc.com)

Prime administrative support contractor to SUPSALV

Provided administrative support to SUPSALV

### **Sandstone Helicopters**

90 Nakolo Pl #2

Honolulu, HI 96819

Provided commercial helicopter for overflights and logistics for SMIT and GPC.

### **SMIT Salvage**

Zalmstraat 1

3016 DS Rotterdam

The Netherlands

P.O. Box 1042, 3000 BA Rotterdam

The Netherlands

Telephone: +31 10 454 99 11

Fax: +31 10 454 92 68

E-mail: [corporate@smitint.com](mailto:corporate@smitint.com)

Web site: [www.smit.com](http://www.smit.com)

As parent to SMIT Singapore, the prime Western Pacific salvage contractor for SUPSALV.

Provided salvage services for the deep-water phase.

### **XYZ Solutions Inc.**

2500 NorthWinds Parkway, Suite 625

Alpharetta, GA 30004

Telephone: (770) 772-3570

Fax: (770) 772-3571

E-mail: [info@xyzsolutions.com](mailto:info@xyzsolutions.com)

Web Site: [www.xyzsolutions.com](http://www.xyzsolutions.com)

Provided 3-D imaging system.



**This page was intentionally left blank.**

## **Selected PowerPoint Presentations**

### **Table of Contents**

1. F/V EHIME MARU Salvage Planning, CAPT. Bert Marsh (28 Mar 2001).
2. Operational Status Brief of F/V EHIME MARU Technical and Environmental Issues, RADM William Klemm (28 Mar 2001).
3. Operational Status Brief of Plans for Recovery of F/V EHIME MARU Crew Members and progress in the Environmental Assessment Process, RADM Klemm (9 Apr 2001).
4. F/V EHIME MARU Salvage Update Presentation, The Honorable Gordon R. England, Secretary Of The Navy (10 Oct 2001).
5. F/V EHIME MARU Crew Member Recovery and Vessel Relocation Plan, CAPT. Bert Marsh (21 May 2001).

**This page was intentionally left blank.**





## ***F/V EHIME MARU Salvage Planning***

CAPT. Bert Marsh  
28 March, 2001



### ***Supervisor of Salvage and Diving***

***Recovery of remains is feasible but there are issues to be resolved. It is a complex operation***

- ❑ Japanese public expectation is recovery of all 9 crew members (cannot confirm they're all inside hull)
- ❑ Precedent setting operation
- ❑ Excess of 750 ton lift
- ❑ Beyond diver capability
- ❑ Fore and aft structural damage
- ❑ Environmental issues require resolution

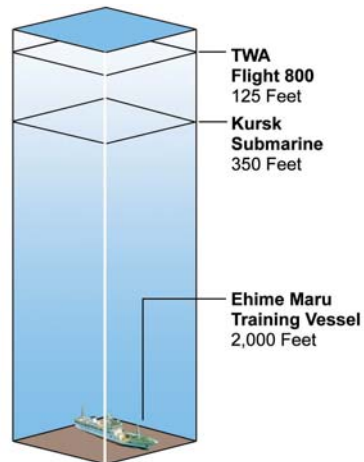



## *Supervisor of Salvage and Diving*

### *Possible Salvage Methods Considered*

#### Intervention on Bottom

- ❑ ROH (Mini) - Not able to enter all discrete compartments
  - ◆ Access to damaged compartments very problematic
  - ◆ Umbilical fouling
  - ◆ Limited maneuverability in high density debris areas
- ❑ Saturation Diving
  - ◆ Safety concerns
  - ◆ Too deep for effective use
  - ◆ No known system certified for this depth
- ❑ Lift to 30m depth – Recover crew members w/divers
  - ◆ Position on bottom for diver access
  - ◆ Place on submerged barge not feasible due to depth (30m)
- ❑ Lift to surface – place in dry dock/deck barge
  - ◆ Initial lift 750 tons – 2000 tons with entrained water
  - ◆ Structural damage issues are exacerbated
  - ◆ Environmental risk associated with lift through air/sea interface
  - ◆ Requires transfer of load from deep lift to shear leg – protected water

## *Supervisor of Salvage and Diving*

### *Lift Vessel Requirements*

#### Lift Vessel Requirements

- ❑ Dynamic positioning (GPS station keeping)
- ❑ Working crane (heave compensated capable of minimum lift 75 tons at 600+ MSW)
- ❑ Deck space for linear winches/fat wire rope
- ❑ Detailed sea keeping data for dynamic lift analysis



## Supervisor of Salvage and Diving

### Phase II - Mobilize Salvage Forces

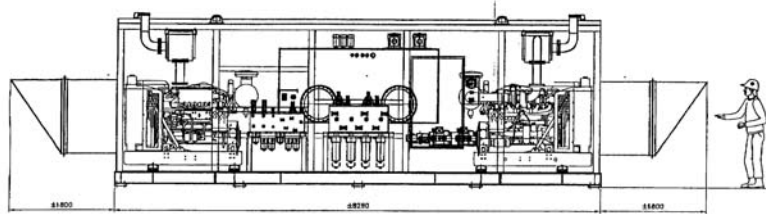

Hydraulic Power Unit

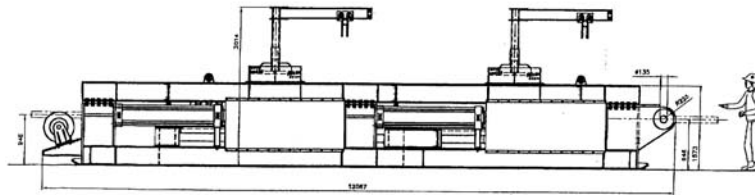

Linear Winch

## Supervisor of Salvage and Diving

### Phase II - Mobilize Salvage Forces



115mm Fat Wire rope

## Supervisor of Salvage and Diving

### Rigging Details

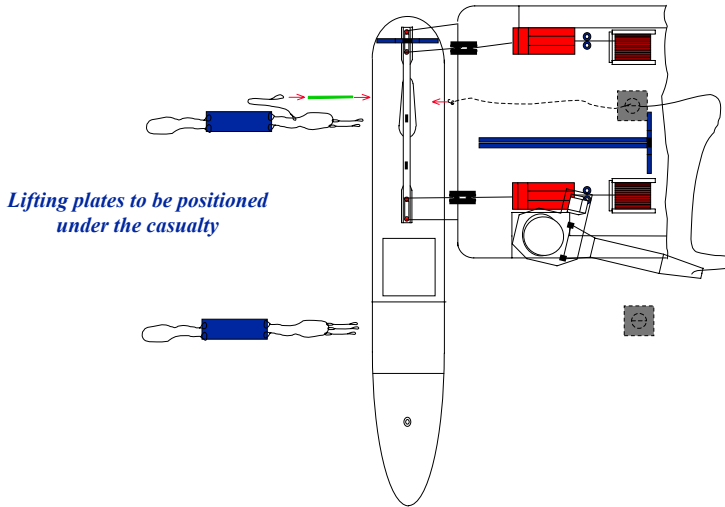

## Supervisor of Salvage and Diving

### Recovery Operation

*Lift to 20-30 M above bottom  
and transit to shallow area*

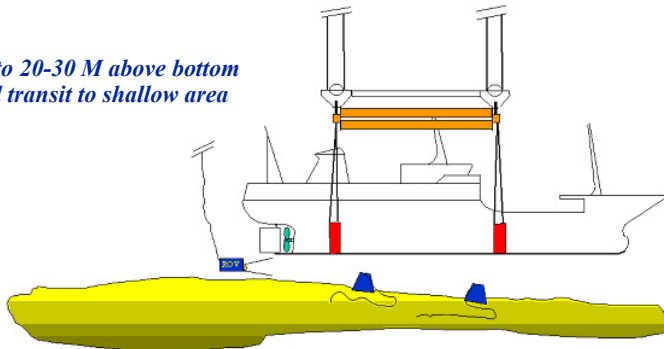

## *Supervisor of Salvage and Diving*

### *Salvage Phases*

**Phase I - Environmental Assessment/Remediation**

**Phase II - Mobilize Salvage Forces**

**Phase III - Rigging with ROVs at 2000 Feet**

**Phase IV - Deep Water Lift & Relocation to 30m Depth**

**Phase V - Post Lift ROV Survey/Recovery at 2000 Ft Site**

**Phase VI - Crew Member Recovery**

**Phase VII - Disposal**

## *Supervisor of Salvage and Diving*

### *Crew Member Recovery Chosen Option – Recovery by Divers*

- Surface-supplied divers
  - ◆ USN and SRF Yokosuka Japanese Divers
- Visual inspection by divers
- Documented with underwater video
- Recovery of crew members by divers
- Utilize U/W tools (cutting, etc.) to access all compartments
- Diver safety **PARAMOUNT**



## Supervisor of Salvage and Diving

### Crew Member Recovery Alternative B – Heavy Lift

- ❑ Structural/stability issues when passing sea/air interface (feasibility TBD)
- ❑ Increased environmental hazards
- ❑ Mobilize heavy lift asset (TAKLIFT 6/8)
- ❑ Lift EHIME MARU via spreader assembly (still rigged)
- ❑ Position on barge
- ❑ Transit to Pearl Harbor
- ❑ Recover crew members



## Supervisor of Salvage and Diving

### EHIME MARU Area Survey

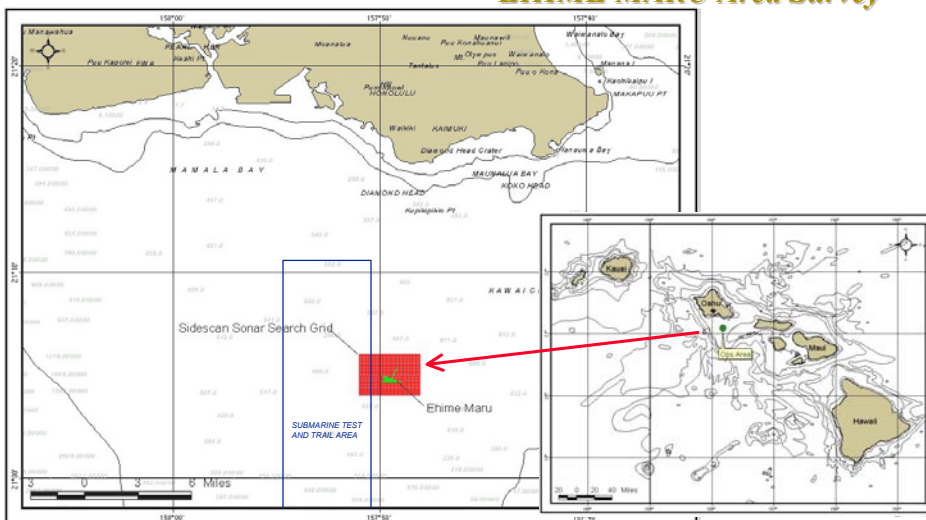





# Supervisor of Salvage and Diving

## Phase I – Environmental Assessment

- ❑ **Worse Case fuel/lube oil loading of EHIME MARU**
  - ◆ Fuel oil = 90,250 gal
  - ◆ Lube oil = 3,316 gal
  - ◆ Sludge oil = 996 gal
- ❑ **Develop pollution response plans**
  - ◆ Will utilize NAVSEA emergency response equipment
- ❑ **Obtain State and Federal permits**
- ❑ **Determine requirements for deep ocean disposal of EHIME MARU after crew member recovery**
  - ◆ Determine deep water disposal permit requirements



# Supervisor of Salvage and Diving

## Response Phases, Spill Risks, Spill Response Capability

Phase	Risk	Spill Response Capability
Deep Rigging	Low	Periodic surveillance overflights 1 Vessel-mounted dispersant spray system on site 2 Skimmer Systems ready standby at Pearl Harbor 2 Helicopter Dispersant Buckets ready standby in Honolulu Full logistic support & standby relief crews
Lift & Relocate	Moderate	Frequent surveillance overflights 1 Vessel-mounted dispersant spray system on site 1 Skimmer System fully operational standby on site 2nd skimmer system standby at Pearl Harbor & meet vessel @ 3 miles 2 Helicopter dispersant bucket systems ready standby in Honolulu Full logistic support & standby relief crews
Shallow Water Ops (Option A)	Low	Periodic surveillance overflights 1 Vessel-mounted dispersant spray system on site 1 Skimmer system standby on site initially and retained as required 2nd Skimmer system ready standby at Pearl Harbor 2 Helicopter dispersant bucket systems ready standby in Honolulu Full logistic support & standby relief crews
Shallow Water Ops (Option B)	High	Surveillance overflight during lift 1 Vessel-mounted dispersant spray system on site 2 Skimmer System fully operational on site during lift 2 Helicopter dispersant bucket systems ready standby in Honolulu Consider additional options (e.g. two tow boats with wide sweep boom) Full logistic support & standby relief crews
Disposal (Option A)	Low	Periodic surveillance overflights 1 Skimmer system accompany vessel to 10 miles offshore 2nd Skimmer system ready standby at Pearl Harbor 2 Helicopter dispersant bucket systems ready standby in Honolulu Full logistic support & standby relief crews
Disposal (Option B)	None	Not required



## Supervisor of Salvage and Diving

### Offshore Skimmer System



*SUPSALV Offshore Skimmer System - Note forward end of oil storage bladder in left foreground, skimmer vessel in center with oil containment "V-booms" forward of the skimmer all towed by a pair of towing vessels*



*SUPSALV Offshore Skimmer System in oil*



*SUPSALV Offshore Skimmer System Aerial View*

## Supervisor of Salvage and Diving

### Pollution Response Equipment



*Helicopter dispersant bucket system*

### Structural Integrity

- ❑ Extent of damage caused by GREENVILLE's rudder unknown
- ❑ Reactions of weakened bow to rigging and lift
- ❑ Ability of hull to withstand lift out of the water

### Mitigation

- ❑ Use conservative estimates of damage aft
- ❑ Conducted sensitivity analysis to rigging impact on the weakened bow structure
  - ◆ Use directional drilling if feasible to install lift plates/multiple wire slings
- ❑ Plan to bring into 30m, place on bottom and use divers for recovery of crew members

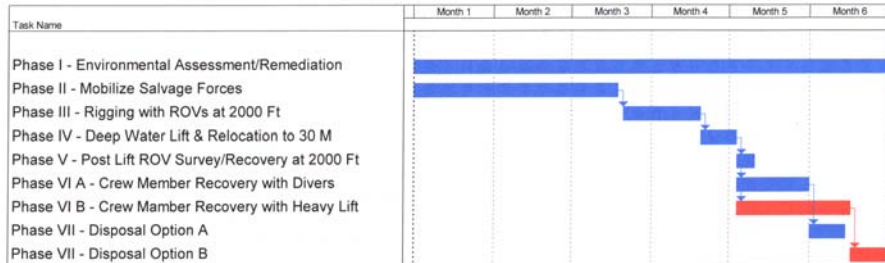



## *Supervisor of Salvage and Diving*

---

### *Cost Estimate*

	Option A	Option B
<i>Phase I - Environmental Assessment</i>	<i>\$ 1.0M</i>	<i>\$1.0M</i>
<i>Phase II - Mobilize Salvage Forces</i>	<i>\$ 21.5M</i>	<i>\$21.5M</i>
<i>Phase III - Rigging w/ ROVs</i>	<i>\$ 6.8M</i>	<i>\$6.8M</i>
<i>Phase IV - Deep Water Lift / Relocation</i>	<i>\$ 3.2M</i>	<i>\$3.2M</i>
<i>Phase V - Deep Water Site Survey</i>	<i>\$ 0.9M</i>	<i>\$0.9M</i>
<i>Phase VI - Crew Member Recovery</i>	<i>\$ 1.8M</i>	<i>\$4.2M</i>
<i>Phase VII - Disposal</i>	<i><u>\$ 1.0M</u></i>	<i><u>\$1.5M</u></i>
<i>Total Estimated Cost</i>	<i>\$36.2M</i>	<i>\$39.1M</i>



---

***Operational Status Brief of  
F/V EHIME MARU  
Technical and Environmental Issues  
RADM William Klemm***

---



---

***F/V EHIME MARU***

***F/V Ehime Maru***

- **Length Overall**
  - ◆ 191 ft
- **Displacement (light ship condition)**
  - ◆ 740 metric tons
- **Draft**
  - ◆ 13.3 ft
- **Max Beam**
  - ◆ 30.5 ft





## F/V EHIME MARU

*Collision Site*

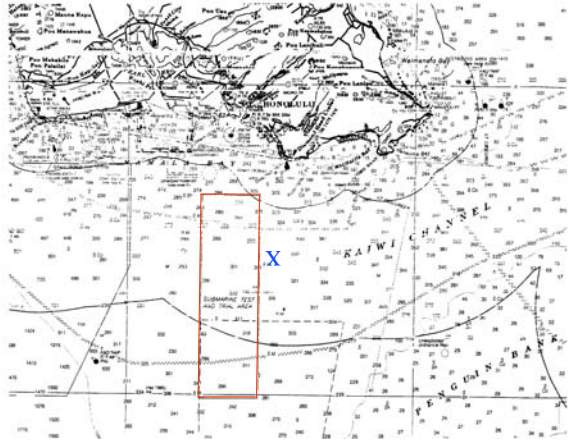

**POSITION 21 05.5 N 157 49.1 W**



## F/V EHIME MARU

*Recovery of remains is feasible but there are issues to be resolved. It is a complex operation*

- ❑ Japanese public expectation is recovery of all 9 crew members (cannot confirm they're all inside hull)
- ❑ Precedent setting operation
- ❑ Excess of 750 ton lift
- ❑ Beyond diver capability
- ❑ Fore and aft structural damage
- ❑ Environmental issues require resolution

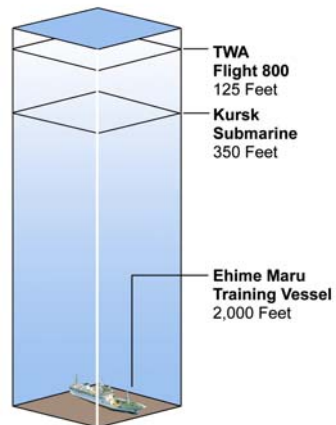





## ***F/V EHIME MARU***

### ***Lift Vessel Requirements***

#### **Lift Vessel Requirements**

- Dynamic positioning (GPS station keeping)
- Working crane (heave compensated capable of minimum lift 75 tons at 600+ MSW)
- Deck space for linear winches/fat wire rope
- Detailed sea keeping data for dynamic lift analysis



## ***F/V EHIME MARU***

### ***Salvage Phases***

***Phase I - Environmental Assessment/Remediation***

***Phase II - Mobilize Salvage Forces***

***Phase III - Rigging with ROVs at 2000 Feet***

***Phase IV - Deep Water Lift & Relocation to 30m Depth***

***Phase V - Post Lift ROV Survey/Recovery at 2000 Ft Site***

***Phase VI - Crew Member Recovery***

***Phase VII - Disposal***



## F/V EHIME MARU

### Salvage Plan

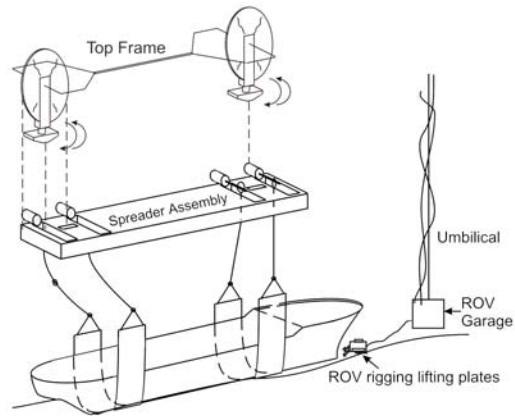

1. Inserting messenger line under hull
2. Rigging lifting plates under hull
3. Attaching lifting plates to spreader assembly
4. Preparing spreader assembly for final lift



## F/V EHIME MARU

### EHIME MARU: Environmental Issues

- Navy will work closely with affected federal and state agencies.
- Locally, regional and state support and assistance has been excellent.
- Engaging trustees and interested parties early.
- Scoping meeting planned for 5 April (State, USCG, USFWS, NOAA, and Navy will attend.)





## ***F/V EHIME MARU***

### ***EHIME MARU: Federal Environmental Issues***

- Endangered Species, Marine Mammals (NOAA Fisheries); Humpback whales, turtles.**
- Ocean Dumping Act (EPA)**
- Migratory Birds (USFWS/DOI)**
- NEPA (EA v. EIS ) time? Significance criteria under NEPA (CEQ)**
- Coral Reef**
- Essential Fish Habitats**
- Oil spills (NOAA)**
- Excellent assistance**



## ***F/V EHIME MARU***

### ***EHIME MARU: State Environmental Issues***

- Working well with the State of Hawaii.**
- State NEPA, ESA, Natural Resources, disposal issues**
- Oil**



## F/V EHIME MARU

### EHIME MARU: Other issues

- Time is an issue
- Whale migration season (Nov-April)
- Weather: summer v. winter
- Plume analysis
- PAO plan
- Japanese involvement
- Potential liability issues
- Security
- Establish Unified Command



## F/V EHIME MARU

### EHIME MARU EA Timeline

TASKS / WEEKS	1	2	3	4	5	6	7	8	9	10
CONTRACT AWARD	X									
MOBILIZATION	X									
DRAFT EA					X					
EA REVIEW						X				
FINAL EA									X	
FONSI DETERMINATION										X

#### ASSUMPTIONS

- REAL TIME FEDERAL / STATE REVIEW
- NO STATE ACTION



## ***F/V EHIME MARU***

### ***Environmental Protection Plan***

***Provide aerial surveillance and standby oil spill response capability commensurate with worst case risk during following salvage phases:***

- Deep Water Rigging** (Moderate risk - Low impact)
- Lift and Relocation** (Moderate risk - Low impact)
- Shallow Water Operations** (Low-High Risk - Mod-High Impact)
- Disposal** (Low risk - Low impact)

***Proposed spill response capability***

- Helicopter surveillance**
- Navy Offshore Skimmer Systems**
- Dispersant capability - vessel mounted & helo bucket**  
(Dispersants via USCG OSC iaw Area Contingency Plan)



## ***F/V EHIME MARU***

### ***Environmental Protection Plan***

#### ***Navy Offshore Skimmer System***

***(Mechanical Recovery is the preferred response option)***

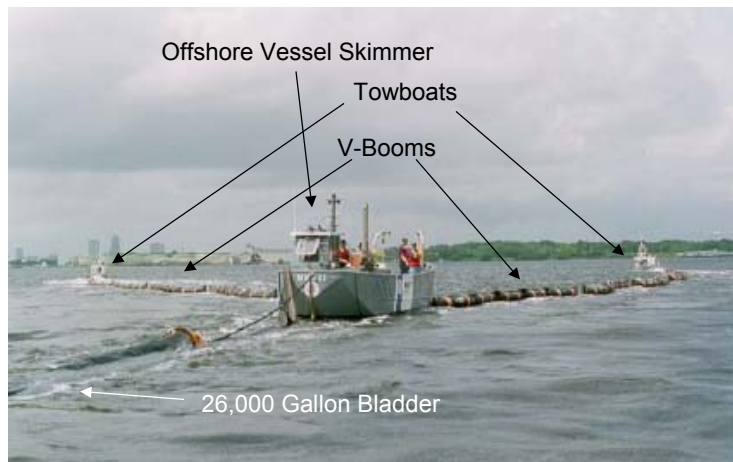



## ***F/V EHIME MARU***

### ***Environmental Protection Plan***

#### **Proposed Dispersant Capability to Backup Skimmers**

- Clean Islands Council - Hawaii Industry Co-op has Dispersant Buckets
- Heavy Lift Helicopters available
- Requires Interagency Coordination & USCG OSC Approval

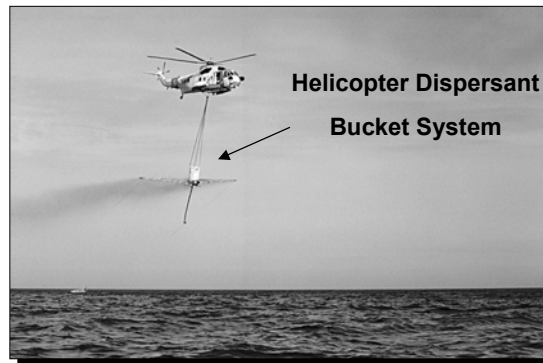

## ***F/V EHIME MARU***

### ***EHIME MARU Conclusion***

- Salvage of Ehime Maru is technically feasible, but will be a precedent-setting operation.
- Some overlap of EA with salvage contract must occur.
- Request full agency cooperation and expeditious review for EA.
- Real time agency review possible because they will be a part of the process. Working group will be established.
- Target is a ten week EA in which to make a FONSI determination.
- If assessment shows environmentally feasible earlier than ten weeks, salvage process may commence.



---

***Operational Status Brief of  
Plans for Recovery of  
F/V EHIME MARU Crew Members  
and progress in the  
Environmental Assessment Process***

---



***F/V EHIME MARU***

---

***Facts sheet on F/V Ehime Maru***

- **Length Overall**
  - ◆ 191 ft
- **Displacement (light ship condition)**
  - ◆ 740 metric tons
- **Draft**
  - ◆ 13.3 ft
- **Max Beam**
  - ◆ 30.5 ft







## F/V EHIME MARU

### Possible Salvage Methods Considered

#### Intervention on Bottom

- ❑ ROV (Mini) - Not able to enter all compartments
  - ◆ Access to damaged compartments very problematic
  - ◆ High potential for umbilical fouling
- ❑ Saturation Diving
  - ◆ Too deep for effective use
  - ◆ No known system certified for this depth
- ❑ Lift to surface – place in dry dock/deck barge
  - ◆ Initial lift 750 tons will increase to 2000 tons with entrained water at air / sea interface
  - ◆ Structural damage issues are exacerbated
  - ◆ Greatly increase environmental risk associated with lift through air/sea interface

#### Method Selected

- ❑ Lift to 30m depth – Recover crew members w/divers
  - ◆ Position on bottom at 30M for diver access
  - ◆ Investigated placement on submerged barge - not feasible due to barge depth required to clear E/M keel



## F/V EHIME MARU

### Salvage Plan – Lift to 30m

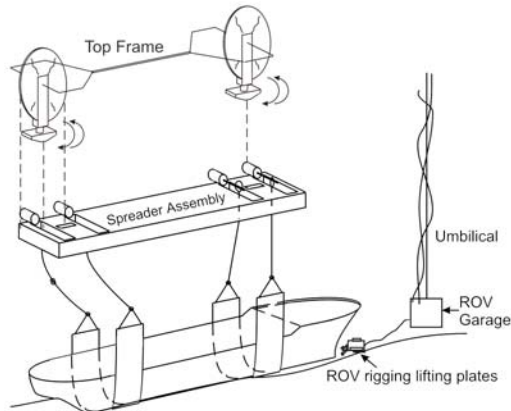

1. Inserting messenger line under hull
2. Rigging lifting plates under hull
3. Attaching lifting plates to spreader assembly
4. Preparing spreader assembly for final lift



## F/V EHIME MARU

### Salvage Phases

<u>Phase</u>	<u>Task</u>	<u>Status / Duration / ETC</u>	<u>Cost Range</u>
Phase I	Environmental Assessment/Remediation	In progress / 10 weeks / Jun	\$1.2M
Phase I - a	Salvage Feasibility Study (Japanese Salvage Mission assisted)	Complete / 2 weeks	\$0.2M
Phase II	Mobilize Salvage Forces	Imminent / 3 months / Jul	\$23.4M to \$35.4M
Phase III	Rigging with ROVs at 2000 Feet	Planned / 1 month / Aug	\$7.0M to \$14.4M
Phase IV	Deep Water Lift & Relocation to 30m Depth	Planned / 2 weeks / Sep	\$3.8M
Phase V	Post Lift ROV Survey/Recovery at 2000 Ft Site (Requested Ministry of Foreign Affairs leader of Japanese Salvage Mission to propose using a Japanese vessel and ROV for this task)	Planned / 1 week / Sep	\$1.1M
Phase VI	Crew Member Recovery (Anticipate Ship Repair Facility Yokosuka Japanese divers to participate with USN Divers)	Planned / 1 month / Oct	\$2.2M
Phase VII	Disposal	TBD	\$1.2M
Total		6 Months	\$40.1M to \$59.5M



## F/V EHIME MARU

### Lift Vessel Requirements

#### Lift Vessel Requirements

- Dynamic positioning (GPS station keeping)
- Working crane (heave compensated capable of minimum lift 75 tons at 600+ MSW)
- Deck space for linear winches/fat wire rope
- Capable of supporting up to 900 ton lift
- Detailed sea keeping data for dynamic lift analysis





## F/V EHIME MARU

### Salvage / Recovery Contracting Status

#### Contracting Issues

- ❑ NAVSEA using existing Emergency Salvage Contract with SMIT International
  - ◆ Conducted feasibility study, defining method of recovery
- ❑ Expect to utilize 3 other U.S. companies for salvage and environmental support
- ❑ Attempting to charter appropriate lift vessel from limited market – in direct competition with off-shore oil industry
- ❑ Current effort – Reviewing technical specifications for Halliburton’s deep sea salvage vessel which completes present charter in late June
- ❑ If vessel meets technical requirements, will negotiate charter ASAP



## F/V EHIME MARU

### EHIME MARU EA Timeline

Tasks	Weeks									
	1	2	3	4	5	6	7	8	9	10
<b>Contract Award</b>	X									
<b>Mobilization</b>	X									
<b>Draft EA</b>	X									
<b>EA Review</b>						X				
<b>Final EA</b>									X	
<b>FONSI Determination</b>										X

#### Assumptions

- ❑ Real Time Federal / State Review
- ❑ No State Action

#### Legend

- = start effort
- X = task complete



## ***F/V EHIME MARU***

### ***Environmental Protection Plan***

***Provide aerial surveillance and standby oil spill response capability commensurate with worst case risk during following salvage phases:***

- Deep Water Rigging** (Moderate risk - Low impact)
- Lift and Relocation** (Moderate risk - Low impact)
- Shallow Water Operations** (Low-High Risk - Mod-High Impact)
- Disposal** (Low risk - Low impact)

***Proposed spill response capability***

- Helicopter surveillance**
- Navy Offshore Skimmer Systems**
- Dispersant capability - vessel mounted & helo bucket**  
(Dispersants via USCG OSC iaw Area Contingency Plan)



## ***F/V EHIME MARU***

### ***EHIME MARU Conclusion***

- Salvage of Ehime Maru is technically feasible, but will be a precedent-setting operation.**
- Some overlap of EA with salvage contract is proceeding.**
- Request full agency cooperation and expeditious review for EA.**
- Real time agency review possible because they will be a part of the process. Working group will be established.**
- Target is a ten week EA in which to make a FONSI determination.**



# F/V EHIME MARU SALVAGE UPDATE PRESENTATION

The Honorable  
Gordon R. England  
Secretary Of The Navy

By Mr. Richard Asher (SEA 00CB)

10 October 2001



## Operational Area

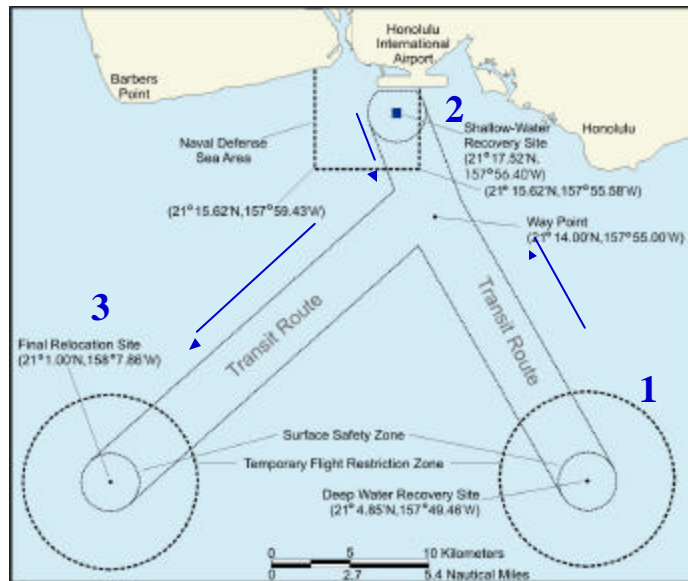



# Recovery Phases



9 Feb 01	Search and Rescue	<i>9 Feb – 5 Mar</i>
Phase 0	Search and Feasibility Study	<i>9 Feb - 12 Mar</i>
Phase I	Environmental Assessment	<i>2 April – 15 Jun</i>
Phase II	Mobilization of Recovery Forces	<i>April – 20 Aug</i>
Phase III	Rigging at DWRS	<i>15 Jul – 9 Oct</i>
Phase IV	Deep Water Lift & Relocation to SWRS	<i>10 – 12 Oct</i>
	<i>Weather Permitting</i>	
Phase V	Post Lift ROV Survey/Recovery at DWRS	
Phase VI	Crewmember Recovery at SWRS	
Phase VII	Prepare Vessel and Relocate Vessel to FRS	
Phase VIII	Shallow-Water Recovery Site clean-up	
Phase IX	Demobilization/Redeployment	



# Phase III - Rigging at DWRS



2. Next, the vessel was lifted by the stern. The aft messenger wire was successfully drawn under the vessel. The forward messenger wire repeatedly fouled at midships.

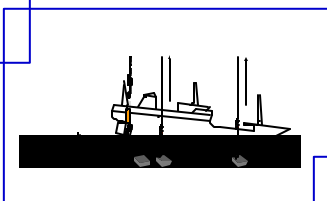

3. The forward lift plate was installed by lifting the vessel by the bow and stern and repositioning the vessel on the forward lift plate.

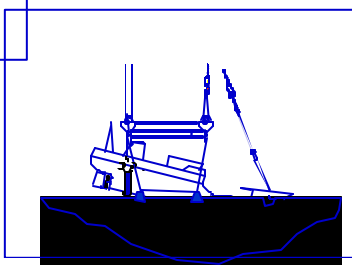

1. First attempt to install the lift plates involved coiled tube drilling beneath Ehime Maru. Unable to get drill head successfully under the vessel's hull.



## Current Configuration

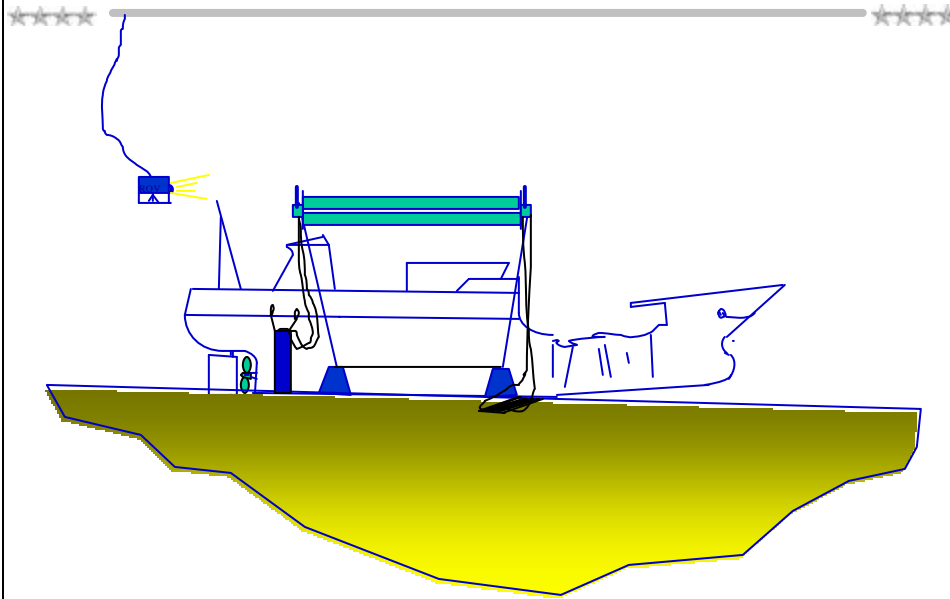

## Phase IV – Deep Water Lift and Relocation to Shallow Water

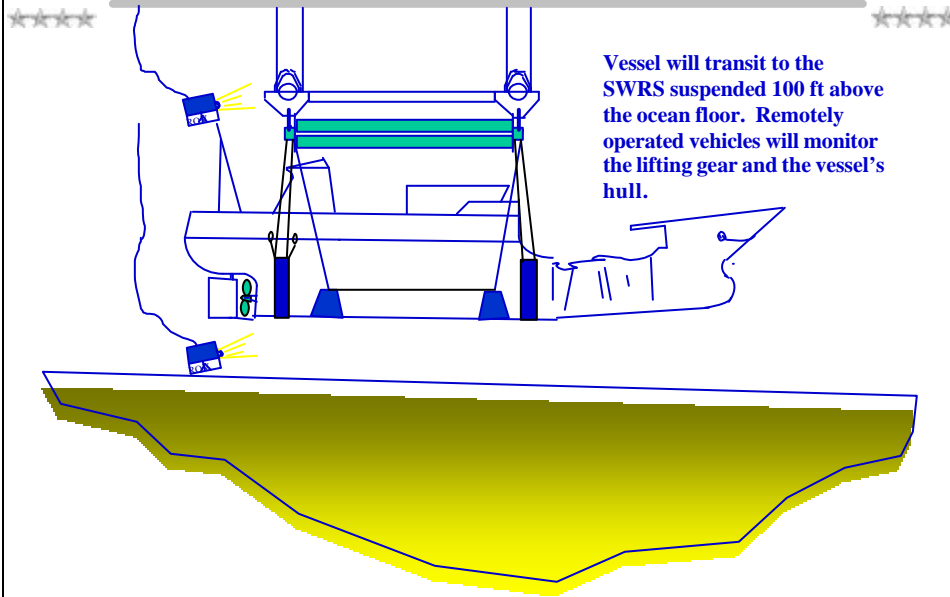



## Phase IV - Transit Route

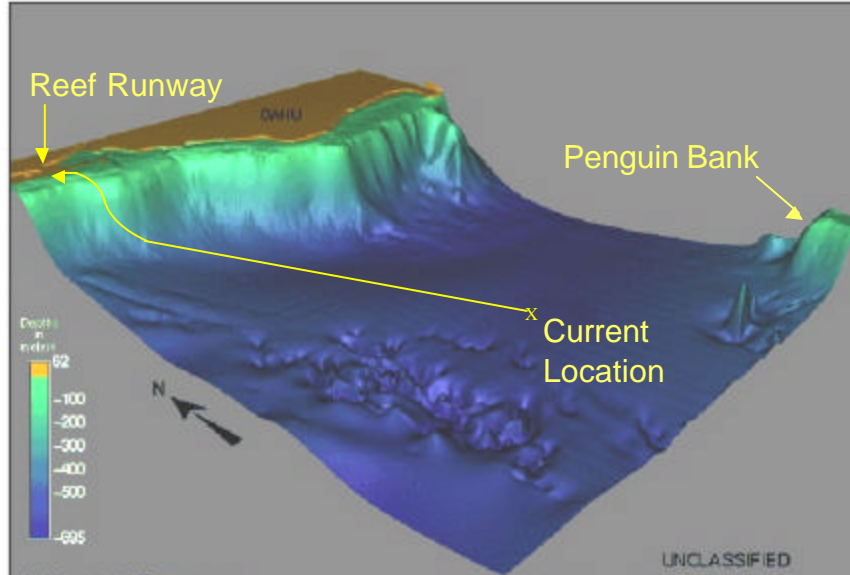

## Phase V – Japanese Vessel *Kairei* and ROV *Kaiko*



- ✦ **Purpose:** The Japanese Deep Sea Research Vessel *Kairei* will survey the DWRS and route to the SWRS to ensure objects of interest have been recovered.







## Phase VI & VII - Crowley Barge 450-10



- ✦ **Purpose: Provide diving platform for recovery operation. Re-lift Ehime Maru using a ballast lift, relocate to the Final Relocation Site (FRS), and release in 6000 feet of seawater.**



## Phase VI - Crewmember Recovery at SWRS



- ✦ **Surface-supplied divers**
  - ✦ USN and SRF Yokosuka Japanese Divers with EOD MUs 3 and 11 assist
- ✦ **Visual inspection by divers**
- ✦ **Documented with helmet-mounted underwater video**
- ✦ **Recovery of crew members by divers**
- ✦ **Utilize U/W tools (cutting, etc.) to access all compartments**
- ✦ **Diver safety is *PARAMOUNT***

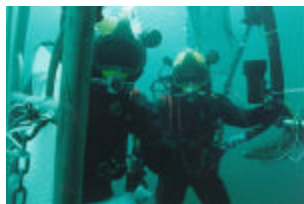



## Ehime Maru Recovery Costs



- ✍ **Original Budget: \$40M. Weather and Technical Challenges Increased Costs.**
  
- ✍ **If EM Moved By 17 October, NAVSEA costs: \$60.8M**
  
- ✍ **CINCPACFLT FY '01 Costs**
  - ✍ \$ 2.9M of OM, N
  - ✍ \$ 1K of EEE
  
- ✍ **CINCPACFLT Projected FY '02 Costs**
  - ✍ \$ 3.0M of OM,N
  - ✍ \$276K of EEE



## Take-Aways



- ✍ **Safety is our Number 1 priority**
- ✍ **Environmental protection critical**
- ✍ **Recovery critical to maintain good international relations**
- ✍ **Unprecedented recovery operation – 830 ton vessel at 2000 feet of seawater**
- ✍ **Technical and operational hurdles caused some delays**
- ✍ **Dignified handling of family members**
- ✍ **Confident in mission accomplishment.**

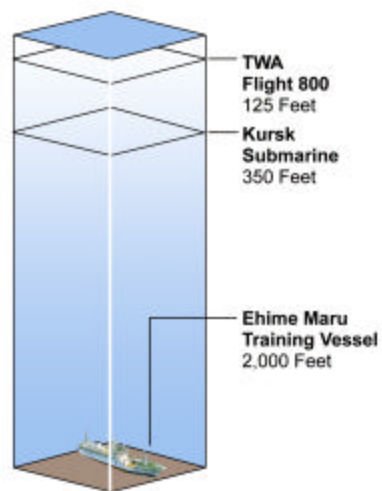



---

*NAVSEA 00C*



***F/V EHIME MARU  
Crew Member Recovery and Vessel  
Relocation Plan***

**CAPT. Bert Marsh  
21 May 2001**

---



***Supervisor of Salvage and Diving***

---

***Agenda***

- Ehime Maru Specs**
- Project Goal**
- Present Condition**
- Salvage Methods Considered**
- Seven Phases of Recovery**
- Schedule**
- Cost Summary**

## Supervisor of Salvage and Diving



• Length Overall:	58m
• Displacement (light ship condition):	750 tons
• Draft:	3.5m
• Max Beam:	9.2m
• Commissioned:	26 Jan 1996
• Fuel capacity:	90.2 k gal (341.60 m3)
• Fuel on Board:	65.0 k gal (72% capacity)
• Lube Oil Capacity:	3.3 k gal (12.55 m3)
• Lube Oil on Board:	1215k gal (37% capacity)
• Kerosene on Board:	48 gal

The Ehime Maru was capable of carrying a total of 67 personnel. The day of the collision, 9 Feb 01, the vessel had 35 people on board. 26 personnel were rescued, 9 personnel were lost. Missing crew members: 4 students, 3 crew, 2 instructors.

## Supervisor of Salvage and Diving

*Recovery of remains is feasible but there are issues to be resolved. It is a complex operation*

- ❑ Japanese public expectation is recovery of all 9 crew members (cannot confirm they're all inside hull)
- ❑ Precedent setting operation
- ❑ Excess of 750 ton lift
- ❑ Beyond diver capability
- ❑ Fore and aft structural damage
- ❑ Environmental issues require resolution

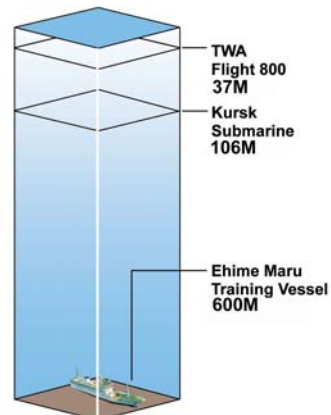



# Supervisor of Salvage and Diving

*Present Condition*



Stbd Side Fwd



Port Side Fwd

# Supervisor of Salvage and Diving

*Forward Damage to Ehime Maru*

**Cross Section - Frame 68**

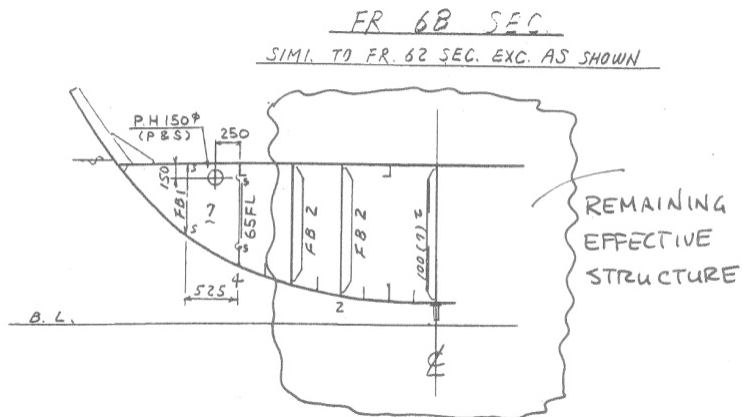

### Cross Section - Frame 18

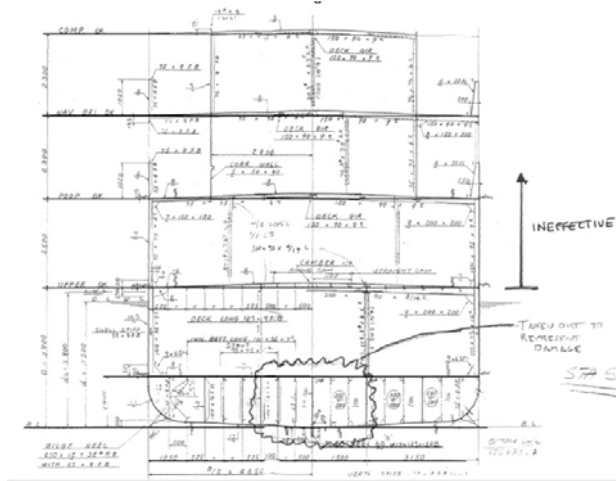

- Phase I - Environmental Assessment**
- Phase II - Mobilize Recovery Forces**
- Phase III - Rigging with ROVs at 600m**
- Phase IV - Deep Water Lift & Relocation to 35m Depth**
- Phase V - Post Lift ROV Survey/Recovery at 600m Site**
- Phase VI - Crew Member Recovery**
- Phase VII - Preparation and Relocation to Deep Water**





## Supervisor of Salvage and Diving

### Environmental Assessment Timeline

Status as of 21 May 01

Week Beginning	4/2	4/9	4/16	4/23	4/30	5/7	5/14	5/21	5/28	6/4	6/11
Tasks / Weeks	1	2	3	4	5	6	7	8	9	10	11
Activate Environmental Team	█										
Mobilization	█	█									
Draft Environmental Assessment	█	█	█	█	█						
Review Environmental Assessment	█	█	█	█	█	█					
Final Environmental Review	█	█	█	█	█	█	█	█	█		
Preliminary Final FONSI	█	█	█	█	█	█	█	█	█	█	
Final EA/ FONSI or NOI	█	█	█	█	█	█	█	█	█	█	█
Assumptions:	Real-time federal / State Review										
	No State action										

Environmental Assessment: On Schedule



## Supervisor of Salvage and Diving

### Phase II - Mobilize Recovery Forces

- Multi-Support Vessel
- Remotely Operated Vehicles (ROV)
- Hydraulic Cable Pullers
- Wire Rope (115 mm)
- Slings and Miscellaneous Rigging
- Strong Backs
- Coiled Tube Drilling System
- Pollution Control System

## Supervisor of Salvage and Diving

### Phase II - Mobilize Recovery Forces

#### M/V Rockwater 2

- ❑ Type of Vessel: Dynamic Positioned Multi-Support Vessel (DP-MSV)
- ❑ Dimensions: 118 x 17 x 5 meters
- ❑ Displacement 3113 Tons
- ❑ Mooring station keeping system: DP, 4-point mooring
- ❑ Lifting Capacity: 150 short tons – Heave Compensated
- ❑ Area(s) of Operation: Worldwide
- ❑ Notes: Deck cargo capacity, 2,750 short tons; clear deck 5,351 sq meters

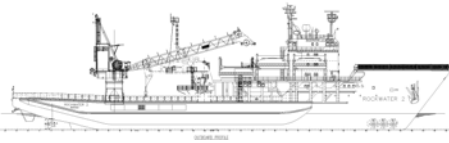

## Supervisor of Salvage and Diving

### Phase II - Mobilize Salvage Forces

#### Multi Support Vessel Rockwater 2

- ❑ 2 linear winches with take up reels and hydraulic power units for 115 mm wire
- ❑ Lift wire fairleads
- ❑ 150 ton heave compensated crane
- ❑ ROVs
- ❑ Coiled Tube Drilling System

Deck Layout, Rockwater 2

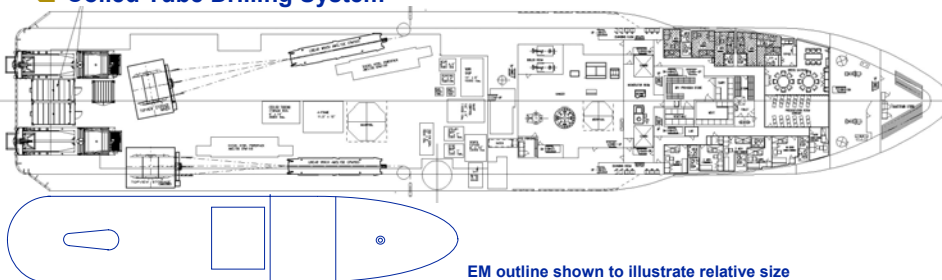

EM outline shown to illustrate relative size





## Supervisor of Salvage and Diving

### Phase III – Rigging with ROVs at 600 Meters



ROV MAGNUM

## Supervisor of Salvage and Diving

### Phase III – Rigging with ROVs at 600 Meters

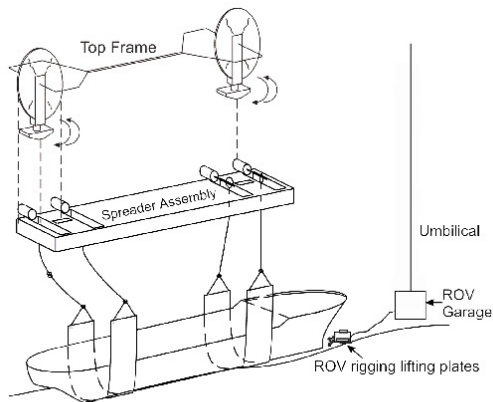

1. Inserting messenger line under hull
2. Rigging lifting plates under hull
3. Attaching lifting plates to spreader assembly
4. Preparing spreader assembly for final lift

## Supervisor of Salvage and Diving

### Phase III - Rigging Options – Jet Drilling

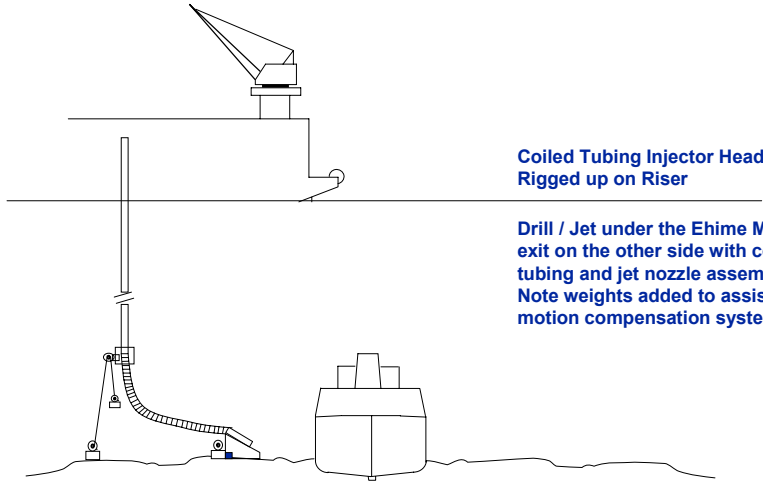

Coiled Tubing Injector Head  
Rigged up on Riser

Drill / Jet under the Ehime Maru and  
exit on the other side with coiled  
tubing and jet nozzle assembly.  
Note weights added to assist  
motion compensation system

## Supervisor of Salvage and Diving

### Phase III - Rigging Options – Stern Lift

*Stern lifted from the  
seabed, both lifting plates  
can now be pulled  
underneath*

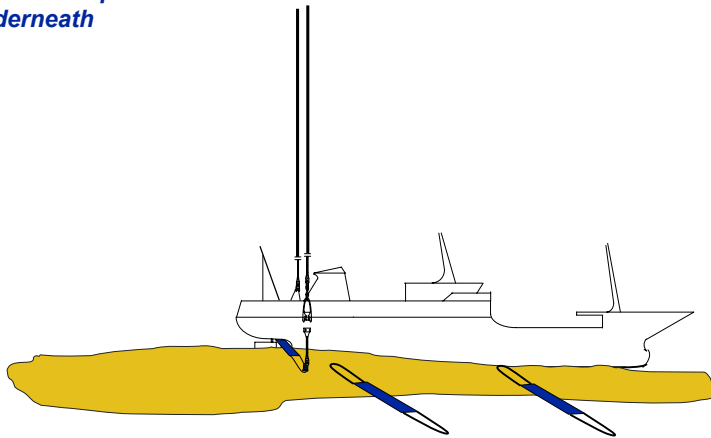

## Supervisor of Salvage and Diving

### Phase III - Rigging Details

With the stern lifted, the lifting plates can be positioned under the casualty

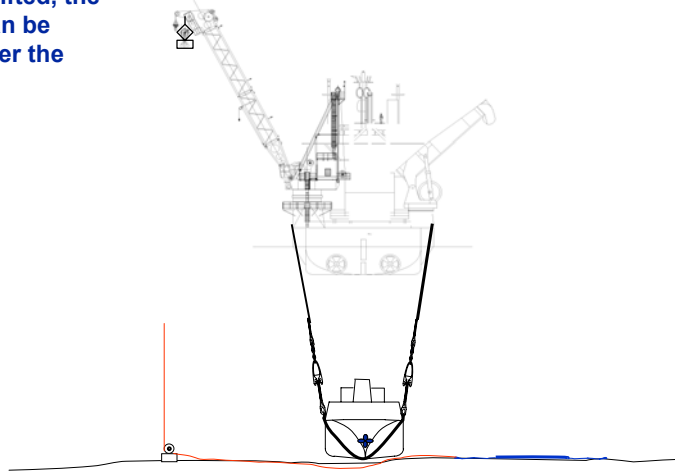

## Supervisor of Salvage and Diving

### Phase III - Rigging Details

Pulling the slings into the spreader beam

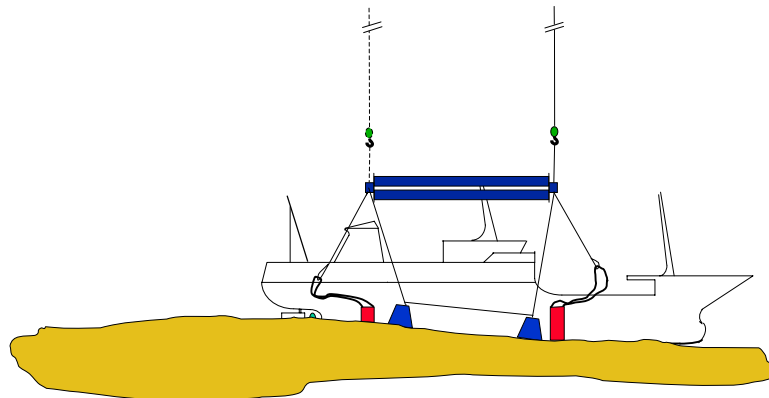

## Supervisor of Salvage and Diving

### Phase III - Rigging Details

Lowering the lifting  
frame into the spreader

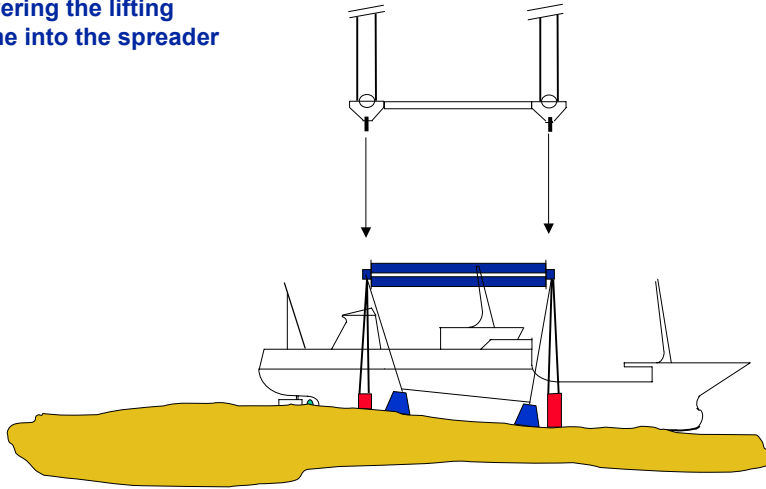

## Supervisor of Salvage and Diving

### Phase IV - Deep Water Lift & Relocation to 35m Depth

- Lower lifting frame to mate with spreader assembly
- Mate and secure
- Raise EHIME MARU off bottom (5-10m)
- Inspect rigging and bottom with ROV
- Transit to shallow water site maintaining safe clearance above bottom
- Reposition on bottom
- Remove lifting frame

## Supervisor of Salvage and Diving

### Phase IV - Deep Water Lift and Relocation

Commence Transit with  
clump weights left behind

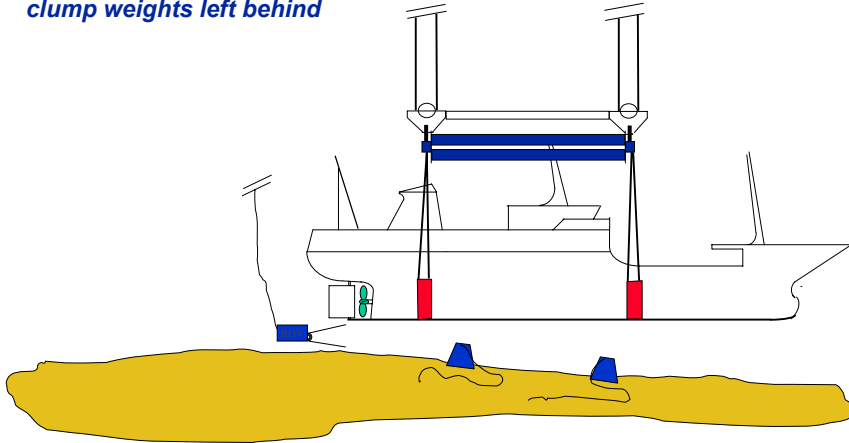

## Supervisor of Salvage and Diving

### Phase IV - Deep Water Lift and Relocation

Transit to Reef Runway Chart  
Bottom Profile or Route

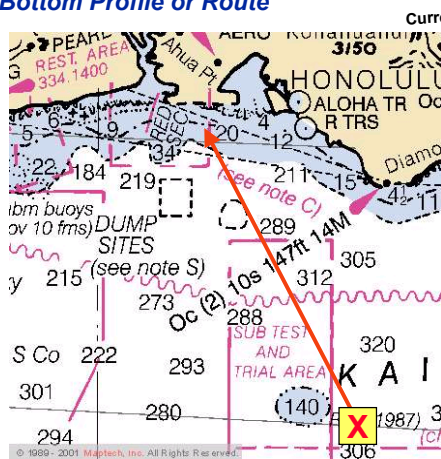

Bottom Profile to Reef Runway Site

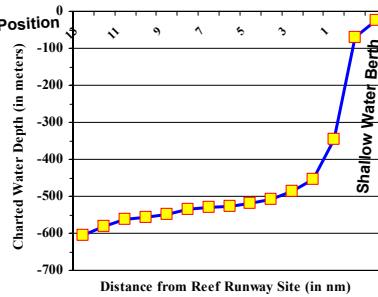

## *Supervisor of Salvage and Diving*

### *Phase IV – Deep Water Lift and Relocation*

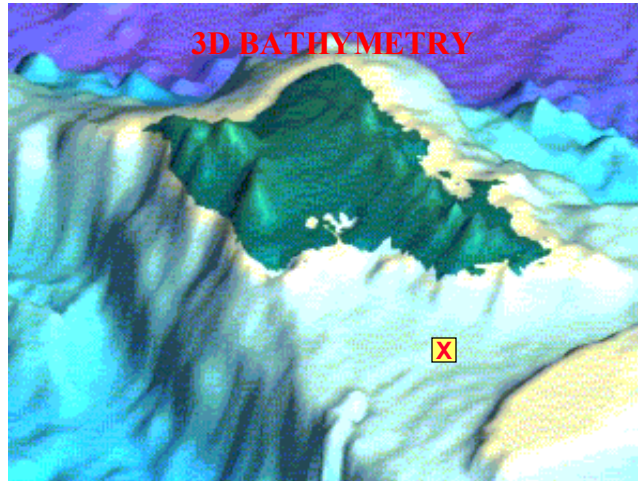

## *Supervisor of Salvage and Diving*

### *Phase V – Deep Water Site Survey*

- Inspect bottom area after removal of EHIME MARU
- Retrieve any remaining debris after lift
- Similar to TWA 800 and other ops
- Utilize ROV DEEP DRONE or Japanese system



## Supervisor of Salvage and Diving

### Phase VI – Crew Member Recovery

At maximum lift, minimum  
water depth - 35 meters

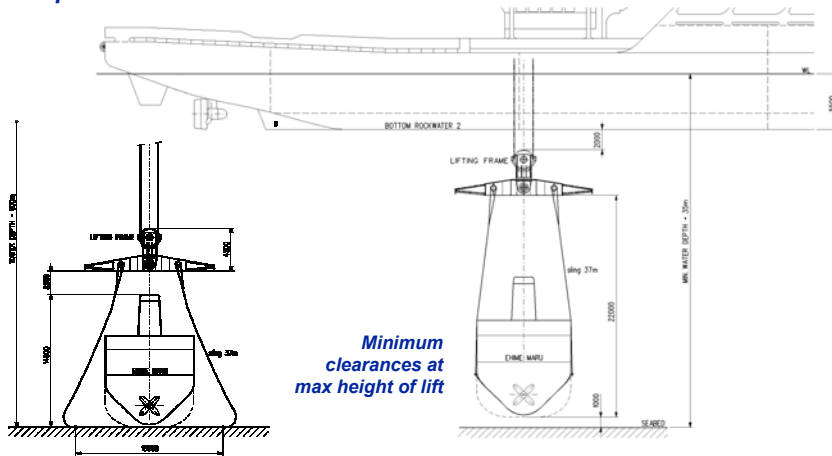

## Supervisor of Salvage and Diving

### Phase VI - Crew Member Recovery

- Surface-supplied divers
  - ◆ USN and SRF Yokosuka Japanese Divers
- Visual inspection by divers
- Documented with underwater video
- Recovery of crew members by divers
- Utilize U/W tools (cutting, etc.) to access all compartments
- Diver safety **PARAMOUNT**





## Supervisor of Salvage and Diving

### Phase VI – Crew Member Recovery

#### Crowley Barge - CMC 450-10

- ❑ Dimensions - 115.35m x 30.48m x 7.62m
- ❑ Gross Tonnage 8099 tons, Deadweight 13,000 tons
- ❑ Moored over dive site
- ❑ Outfitted with 2 surface supplied dive systems
- ❑ Spill response equipment on board
- ❑ Configured for lift of Ehime Maru (ballast lift) and transport to deep water site
- ❑ Configured to accept recovered fuel and lube oil



## Supervisor of Salvage and Diving

### Phase VII – Empty Vessel Relocation to Deep Water

- ❑ Crowley Barge lifts Ehime Maru using ballast lift (Maximum lift 4.5 meters)
- ❑ Transit to disposal site using 2 tug boats
- ❑ Release Ehime Maru using either explosive or mechanical release
- ❑ Depth in excess of 1000 fathoms

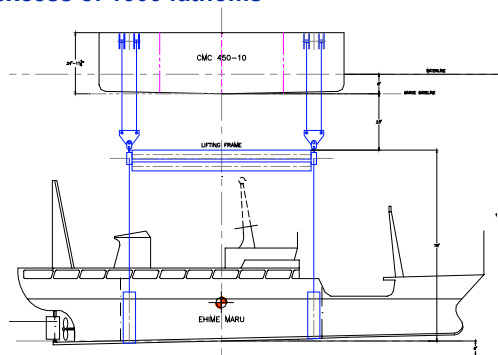



# Supervisor of Salvage and Diving

## Schedule

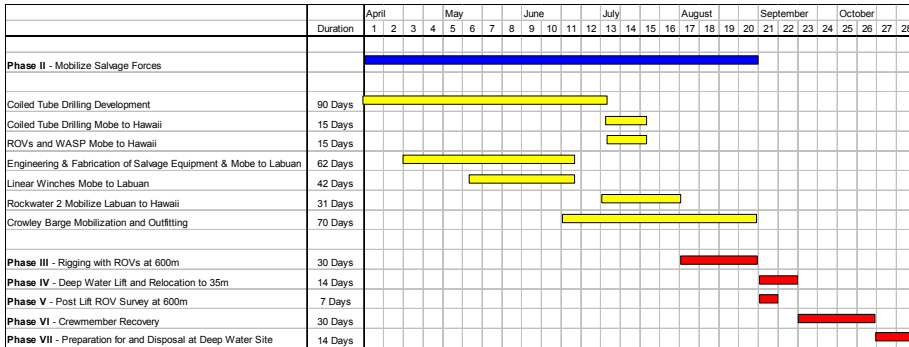

# Supervisor of Salvage and Diving

## Cost Estimate

<b>Phase I - Environmental Assessment</b>	<b>\$ 1.0M</b>
<b>Phase II - Mobilize Salvage Forces</b>	<b>\$ 17.5M</b>
<b>Phase III - Rigging w/ ROVs</b>	<b>\$ 7.5M</b>
<b>Phase IV - Deep Water Lift / Relocation</b>	<b>\$ 3.5M</b>
<b>Phase V - Deep Water Site Survey</b>	<b>\$ 1.0M</b>
<b>Phase VI - Crew Member Recovery</b>	<b>\$ 5.0M</b>
<b>Phase VII - Disposal</b>	<b>\$ 2.0M</b>
<b>Total Estimated Cost</b>	<b>\$37.5M</b>

*Appendix I*  
**Press Briefings**

**Table of Contents**

EHIME MARU Recovery Media Briefing.....I-2  
Meteorology, Oceanography Press Conference .....I-18  
Salvage Supervisor Updates Media .....I-20  
Transcript: Update by Rear Adm. Klemm .....I-30  
Transcript: Update by Capt. Bert Marsh.....I-32  
Rear Adm. William Klemm: TRANSCRIPT: EHIME MARU Relocation Brief .....I-44

# EHIME MARU Recovery Media Briefing

CPF HOME EHIME MARU RECOVERY NEWS

## Transcript

**Speaker: Rear Adm. William Klemm, recovery operation commander**  
**This media brief included a PowerPoint slide presentation**

---

Aug 2, 2001 -- Rear Admiral Klemm: We're here today to give you a brief of the (inaudible) of the operation to recover remains on the EHIME MARU and I'm going to probably darken the room here and show some slides. The information that we provide today is available on the website; it can be electronically downloaded if you want the images for broadcast. If that information is not sufficient here, then you should be able to get the information that you're looking for on the web site.

So let me go ahead and begin.

As I mentioned, we're here on a humanitarian mission to recover remains of the crewmembers that were left aboard EHIME MARU. We have been engaged.

(Pause)

We have been engaged in this operation now for a considerable period of time. We started at the beginning of April with an environmental assessment, which ended in June. We went into a mobilization effort, which has continued through today. The point that we're at today, the Ocean Hercules has completed its preliminary preparations. ROCKWATER, as you know, is here alongside the pier. We'll visit ROCKWATER after this press conference and you'll be able to see some of the concepts that we are going to demonstrate here in slide form. We'll get right into it.

Next slide, please.

The condition of the ship as it sits on the ocean floor today, there is about a five-degree starboard list, it's leaning to the right. It sits in a very soft sediment with a clay underlayment and the actual condition of the ship, as you can see, it now has been crumpled and is no longer in line with the rest of the hull form. The hull is intact as it sits. Part of the operation that has been conducted by Ocean Hercules up to this point was to remove the forward

mast and the main mast to clear the lifting height of the equipment that ROCKWATER will install on board the ship.

Next slide, please.

The phases of the recovery, I mentioned that we had completed the environmental assessment. We have been continuously in a mobilization effort. That is we bring the ships and the equipment on-line as required. The rigging operations at the deep water began with OCEAN HERCULES' arrival several weeks ago and it will proceed in earnest on the 6th or 7th roughly as ROCKWATER completes her outfitting here and moves out over the site.

The remainder of the operation, the lift and transfer itself, the crewmember recovery, the diver operation portion that will take place in the shallow water site, prepare the ship for relocation again, cleaning our shallow water site to put it back in the condition that it was in before we arrived, and then demobilization of all the equipment. We'll talk a little bit about each one of these phases as we go on.

Next slide.

The time line as we have it, the darker areas here are already completed. That is those vessels have already arrived. The operations, as we see projected right now with ROCKWATER, as I mentioned, going out over the site on Monday or Tuesday of next week. So the timeframes are arrivals and not specifically the time that the ship is employed.

The Crowley Barge 450 is our dive barge. Again, we'll see illustration of these a little bit later, but that is the barge that will support the diving operations over the shallow water site.

Then a Japanese Maritime Self Defense Forces ship, probably a submarine rescue ship, will provide support of Japanese divers near the end of the shallow water diving operation and will participate in the closure of the ship and the inspection of the shallow water site after the ship has been relocated.

Next slide.

The Crowley Barge 250 fits in front of the ROCKWATER today. When you go out to visit the ship you will see it and much of the equipment that it has brought with it from California. It consists of the ROVs from Canyon, the drilling equipment that will be used, and I'll show you that in a little while. The generators and all of the heavy equipment that supports the diving operations on ROCKWATER, it will also be used to shuttle that material back and forth to the deepwater site.

## **F/V EHIME MARU Recovery and Relocation Report**

Next slide.

The OCEAN HERCULES, the slides here are too light to see the illustration of the ship, but it also sits at the pier today. It is in the process of demobilization. Her mission is completed and she'll be getting underway tomorrow for her next work site.

She did some initial surveys, cleared debris, and we did determine that there was significantly more debris outside than we had anticipated, significant amounts of long line material, monofilament line that had to be secured to avoid towing our equipment as we get into the operation.

She did clear the center and forward mast from the ship. She did some dredging for the lifting straps that will go underneath the ship, and she has successfully installed a transponder array that will be used for electronically positioning the ROVs underwater.

Next slide, please.

The ROCKWATER, again you'll visit the ship shortly. She has a singular mission and that is to lift and transport the ship. She will provide the platform from which the working class ROVs as well as the 402 drilling equipment will be staged and utilized. Once she has installed all of the lifting gear she will lift the ship and move it to shore. Again, some slides will illustrate how we go about that process.

Next slide, please.

As the ROCKWATER, and this is the 402 drilling equipment. Essentially what this equipment will do is bore a hole underneath, through the sea sediment underneath EHIME MARU. When it comes out the other side it will take a messenger line from ROCKWATER, pull it back through, underneath the ship, attach the lifting plate. The ROCKWATER will pull the lifting plate back through underneath the ship, and that will place the two lifting straps that will actually be used to raise the ship.

Next slide, please.

Once those straps -- you see the straps in blue -- are placed underneath the ship. Then the lifting equipment, the spreader assembly, and the lift arm will be installed. There are a series of weights used here because the spreader assembly itself is buoyant and will maintain a strain on the lifting equipment.

Once that equipment is attached together the ship will be ready to be lifted.

Next slide.

I want to point out, we have two gentlemen with us today. Mr. Fujii and Mr. Takemoto, over to my right here. These distinguished gentlemen from Japan were a part of the initial survey. They did participate in the feasibility study and their technical expertise has been requested and graciously provided during the course of the recovery operation so that they will actually participate on board the ROCKWATER.

Next slide, please.

Once we have installed the lifting equipment and raised the ship from the bottom, you see an illustration of an ROV. There will actually be three ROVs on board ROCKWATER. Two of those are working class. That is their manipulator arms are built to provide support for operation of this equipment. The other one is an observation ROV that will be used for recording and visuals.

Once we have raised the ship in the position that you see it here, roughly 90 feet above the bottom, there will be a very thorough inspection of the structural damage to the ship by the two ROVs to provide us with an assessment as to whether or not the estimates of damage that we had used in our calculations of structural integrity are valid. If we have the structural integrity that we had anticipated, then the ship will be ready to move.

If it is not, that is the structural integrity of the ship is in question or the structure fails, or we find that the structural damage is significantly greater than we had anticipated, we may then have to make an assessment of the desirability to continue the mission based on the likelihood of entire structural failure.

Next slide, please.

The current location, and what you see here is the symmetry of the ocean floor as provided to us USNS SUMNER. This data shows the canyon that was the original outfall of the Pearl Harbor water plane back in the ice age, I presume, where the water level was several thousand feet shallower than it is today. The point of this slide is to show you that there is some considerable variance in the topography of the ocean floor at this point and we must choose a path to bring the ship into the shallow water site that does not pass over some of these obstacles where we might get into either currents or potential obstacles that would prevent us from passing.

So while this looks like a straight line, it is not a straight line. It actually curves to get to the shallow water site. For those of you familiar with the hydrographics in the Hawaiian Island

## F/V EHIME MARU Recovery and Relocation Report

chain, the Penguin Bank actually is a shallow area in between Oahu and Molokai, and that is a fish habitat, very rich fishing ground, and very sensitive area that we're very much concerned about. The other areas that show in the lighter color based on their depth are also marine sanctuaries and protected by several acts under our environmental protection regulations.

Next slide, please.

Unfortunately, our illustrations that are the backdrop here don't come out very well. We do have illustrations of most of these ships here on posterboard if you need to pick up visuals.

The Kairei is an oceanographic research vessel owned and operated by Japan. It is operated by the Ministry of Education and Science. It will be in the Hawaiian Island chain on a mission for several months. During that period of time they have agreed to provide support at the deepwater site with their ROV, the Kaiko, that will do a bottom search grid survey after we have lifted EHIME MARU.

Next slide, please.

This is the Crowley 450 barge. This barge, as you can see, is outfitted with berthing quarters, conference spaces and other material support, food services, to provide support to our dive teams, salvage experts, that will be operating off of this deck. The configuration that you see on the deck today is not what we will have out at the site. This barge will be chock-a-block full of diving support equipment. So the oil pipeline equipment which you see in this illustration will be removed for that operation.

This vessel will also be used to pick up and relocate the EHIME MARU at the completion of the operation. This barge is very large, 350 feet long, has the ability to balance itself down, attach to the lifting mechanism that will bring the EHIME MARU into the shallow water site, balance herself back up to pick up the weight, and then carry it out to sea.

Next slide.

As I mentioned, the Japanese Maritime Self Defense Force will provide a ship. The announcement of which ship it is still pending in Japan right now. We believe that it will be one of the submarine rescue ships that will provide diver support for JMSDF divers that will be involved in the operation along with Navy divers and divers from the Yokosuka ship repair facility, the labor contract employees of the government of Japan who work in the SRF.



Next slide, please.

The \_\_\_\_, again the illustration doesn't show here is the U.S. Navy's submarine rescue ship homeported here in Pearl Harbor. She actually has several missions to accomplish during this operation, the primary one being the shallow water recovery site restoration, diving support at the shallow water site that KAIREI and the deepwater survey with the ROV-D drone which will be aboard the USS SALVOR.

Next slide.

This illustration is a very good one. It's not very clear here, but this shows the topography essentially of where the ship is now, where we will move it to at the reef runway, and then you can see as the color changes to a deeper blue/purple color, that is the thousand fathom curve, roughly 12 miles from Barber's Point, and beyond that thousand fathom curve, 6,000 to 8,000 feet of water, the relocation of the EHIME MARU scheduled right now to take place in October.

I think that pretty much wraps up the formal presentation. At this time we're prepared to take some questions. Once we have satisfied the desire for questions we'll move over to ROCKWATER where we will give some in-depth exposure to the equipment that's going to be used over there and actually get an appreciation for how complex this operation is. It's going to be very crowded over there.

Yes, sir.

Q: When the ROCKWATER 2 is done and moved to the shallow water site does it disconnect totally, (inaudible) on the floor, and that's when the 450 then comes in and... When does the 450 (inaudible) pick it up?

A: That's a good question. I should have said that.

The ROCKWATER's mission is to bring the ship to the shallow water site. Once it is placed in the shallow water site and stabilized, ROCKWATER will disconnect and she'll be demobilized at that time. Immediately thereafter, or as soon as we can get the 450 barge forward, in fact a local company, [Helie Tibbits], is out today to install the mooring system for the Crowley barge that will already be in place. So once the EHIME MARU is placed in the shallow water site and the 450 barge is ready for diving operations it will move out and pick up its mooring.

Q: (inaudible) the area (inaudible)?

## **F/V EHIME MARU Recovery and Relocation Report**

A: The question is where is the greatest damage on the ship.

The greatest damage that is visible at this point in time is the collapsed structure in the [four feet] of the ship where the bow is lifted. The expectation that we have is that there is damage, extensive damage along the heel line of the ship, probably from mid ships aft. That is under the sediment at this time and cannot be viewed. So the real assessment will take place when we can actually get the ship up off the bottom and view that for the first time using our ROVs.

Q: Admiral, how would you rate this operation in terms of complexity and Navy experience doing something like this?

A: The Navy has got lots of experience with salvage operations and you will have an opportunity to address our lead salvage man, the Supervisor of Salvage, Captain Bert Marsh will meet you on the ROCWATER 2 and be available to discuss this and many other projects.

The Navy has raised ships from the Suez Canal at the end of the Gulf War years ago; and that experience has essentially not stopped. So continuously recovering objects from the ocean floor -- aircraft, small craft, ships. What makes this operation unique is the fact that with 2,000 feet of water it's a fairly large ship to be raised from such a deepwater berth. That has not been done. We're well beyond the capacity, the depth that divers operate. As a consequence, everything has to be done by remote control.

As I mentioned in a previous press conference, had this occurred 15 years ago we would not have been able to undertake this operation because the technology simply did not support it.

So I think I've answered your question there.

Q: Admiral, you said when the ship is lifted off the bottom of the ocean floor that another assessment will be made. Do you have any idea of what odds or how severe this damage may be? What's your margin of error here? How likely is it to be able to continue...

A: That's a good question. We did what we considered to be a conservative estimate of the amount of damage. That is we would err on the side of weakness in the structure in order to have some assurance that we have a sound engineering solution. That is based on a number of facts that we do know. We can calculate the size of the opening in the ship's hull by amount of time that it took to fill and so on.

Based on factors that have been accumulated, we think we have about an 80 percent chance of hitting it on the money. That means that we perhaps have as much as a 20 percent chance of failure.

Q: But the goal would be to get to the point where the damage assessment (inaudible)...

A: I will tell you that we have done a tremendous amount of work up to this point to prepare to get to this point. If everything works the way we have planned it could be as fast as two weeks or four weeks.

The expectation is that we can do what we have set out here. But we're going to be using some equipment that has never been applied in this fashion before. The 402 drilling equipment, for example, is common oilfield technology today. It's never been used submerged at 2,000 feet. So how it reacts under 60 atmospheres of pressure is going to be the question.

If it reacts the way we expect it to, then it will be a relatively short period of time. The risks that it won't are still there.

Q: Environmental concerns, obviously there are many. What kind of hoops does the Navy have to go through to make sure that everything is in place environmentally?

A: Our environmental assessment essentially identified several factors that were environmental insults that required addressal here. The most prominent of those certainly is the petroleum products that are on board. When she sailed she had 65,000 gallons of fuel oil on board and another 3,000 gallons of lube oil. We had some very conservative calculations that said probably two-thirds of that was still on board when the ship sank.

We think today after some of the preliminary survey work that was done by OCEAN HERCULES that the amount of fuel remaining on board is significantly less than that, perhaps less than 10,000 gallons.

In any event, whatever oil is in the ship today potentially can be spilled and that is a major concern. We have addressed that within our environment assessment to the satisfaction of the regulatory authorities and we have the equipment to deal with it.

Other areas of concern, the long line fishing equipment and nets and light weight material that might come foul on coral reefs or in fact might cause problems with some of the marine mammals. We have since found that the long line equipment does not have the hooks

## **F/V EHIME MARU Recovery and Relocation Report**

installed and netting materials that were originally thought to be netting materials identified on the ship in fact are not netting material.

So the primary concern, marine mammals and the coral reefs we think are pretty well covered at this point both by the discoveries that we've made and our ability to control the escape of that material.

Q: Did you say the ROCKWATER 2 (inaudible)?

A: That's correct.

Q: (inaudible)

A: We don't have an exact timeframe because there's a lot of equipment that physically has to be installed. That is, attached to the deck, welded down, tested, hooked up to power and hydraulic systems and so on, and that's going on 24 hours a day starting yesterday and will continue until the ship is ready. When it's ready, we're getting underway.

Q: Should the plan fail, is there a plan B?

A: Tough question. If a piece of equipment fails, the plan B is typically that we have backups for all the equipment. If we really get down to the point where a major structural element of the ship fails we will have to do an assessment at that time, but chances are very good that we will not be able to move the ship under such circumstances.

Q: How long will you give it to try and get the equipment underneath the ship?

A: We will go as long as it takes. Our expectation is that we have a primary method to get those straps installed under the ship which is the core drilling equipment, the 402 drilling. If that fails, then we have a backup method to get those straps under the ship.

I have very high confidence that we will get to the point to lift the ship. I think the much greater risk comes at the point where we lift the ship and do the damage assessment and determine the suitability for continuance. We will have to move this ship [about 14 miles] and raise it 1800 feet from the ocean floor, so there is considerable risk involved in those evaluations if the structural integrity of the ship is in question.

Q: What is the significance of the (inaudible)?

A: Yes.

Q: (inaudible)

A: If you're standing on this flat ground, you can appreciate the fact that we're pretty much horizontal. A five-degree list simply means that the ship has lifted. Not only would you find yourself walking at an angle on the deck, but any petroleum products that have been released inside the ship will now seek the highest point. So that has a tendency to funnel and channel oil flows through the ship to certain locations. Basically that's how we determine roughly what oil is in the ship.

Q: How (inaudible)?

A: It technically doesn't impact rigging. Nothing that we do at the deepwater site would be impacted by the amount of oil that there is on board the ship. On the other hand, once we move the ship if we stand it right up or if we lift it the other direction, now that oil has a different flow path, so the potential for the oil to be released is dramatically increased. As a result then the plans that we have to mitigate oil distribution on the surface of the ocean would have to come into play.

Q: (inaudible)

A: It's more an environmental concern, not mechanical movement of the ship.

Q: (inaudible)

A: I'll just give you a range because, let me explain it to you.

In order to move the ship into shallow water and control the environmental or potential environmental insult, we need to move the ship when we have the right set of circumstances. There are four conditions that lead to the right circumstances to bring the ship into shallow water. One of those is tradewinds. We would like to have 15 knots or more of tradewinds. That helps to keep the oil stabilized and any releases that we have, we know where it would go based on modeling that we've done.

We have to have currents, the postal currents of the islands in our favor.

We need to have the tides in our favor. That is we want to bring the ship into the shallow water site during an outgoing tide. That will prevent oil from entering either Pearl Harbor or Kaidi Lagoon and the downtown area of Waikiki.

## **F/V EHIME MARU Recovery and Relocation Report**

Finally, we have to have the sea state, that is the waves - both the swells coming from the southern hemisphere and the wind-driven waves at a height that is low enough to support the lifting and transportation of the ship.

So when those four conditions are met we can then move to the shallow water site.

What I'm telling you is if we were ready to lift the ship tomorrow but we didn't have the right weather conditions, we would have to sit and wait until we do have the right weather conditions. So the operation is not solely dependent on man. We need some help from Mother Nature here to successfully execute this.

Q: So you (inaudible).

A: We have enlisted the support of the Navy's meteorological team. They have provided us extraordinary support. That will be the subject of another press briefing a couple of weeks from now, I believe it's the 17th of August. USNS SUMNER will come downtown Honolulu here to give you an idea of what it is they're doing to support this operation. It's not just how fast are the winds blowing and how big are the waves going to be, but what is the current at each level all the way down to 2,000 feet, and as we move the ship into shore, how the currents are varying as we move the ship so we know what effect there will be on the EHIME MARU as it is moved through the water.

It's a very complicated issue, but real time monitoring using buoys as well as Sumner's equipment to provide us some of those inputs.

Q: (inaudible)

A: I'm not sure I understood your question, sir. Could you repeat that?

Q: When is the earliest date?

A: Probably around the middle of August would be the earliest. I would say the 20th is the earliest date, and based on weather and effectiveness of our equipment, we have a window that runs through about the middle of September. That's our expectation at this point in time.

And as I said, if everything worked the way we would expect it to mechanically, we may still have to sit and wait for the weather to match.

Q: (inaudible) the 13th, the ROCKWATER 2 goes out on the 13th.

A: That's the 6th or 7th.

Q: Then how much time before it can actually start with the weather conditions and everything else.

A: Once she's over, the weather limitations for work are much less than the weather limitations for actual movement. So the present weather conditions are pretty significant out there, 10-12 foot seas, up to 30-knot winds, it's pretty tough on the ships that are hanging around. But the ROVs, of course are operating at depth and they're not affected by the topside weather. So we can continue to operate and rig at the deepwater site, but the actual lifting would be held until we had the right weather conditions.

Q: Assuming you are able to pick it up off the ocean floor and you feel the damage is minimal enough at least to move it, how difficult is it then to move it with basically several hundred feet or so, (inaudible) the ROCKWATER to the EHIME MARU. How difficult is it to move it along and not just have things flaying in currents or anything else?

A: It's a good question and that's one of the reasons why USNS SUMNER will provide an escort in there to tell us what the currents are doing down there. Obviously the currents are different at depth than they are at the surface. We're limited in the speed that we can move the ship. Typically to about one knot or less -- that's one nautical mile in an hour. The lifting sequence calls for raising the ship at approximately one meter per minute. If we calculate that out then you can see that to raise it that height it's going to take it about 10 hours. We're about 12.5 miles from the shallow water site, so if we were just headed straight in it would take about 12.5 hours if we were to make one knot good.

So the length of the operation could be two days if everything worked right. It could be a lot longer than that if it doesn't.

Q: (inaudible)

A: It's not very likely that we could salvage the pieces if the ship breaks. I say that because the method that we're lifting the ship by is designed to hold the ship together. If the ship fails, it's because there is damage beyond the scope of what we've estimated. That means the ship will probably be in multiple pieces.

The entire purpose for this operation, again, is the humanitarian mission of recovery remains. If we have broken the ship so severely, then we will prevent us from executing that

## **F/V EHIME MARU Recovery and Relocation Report**

mission period. So it is not likely that we would be able to continue the operation if that structural failure occurred.

Q: You mentioned that the ROCKWATER (inaudible) around August 6th or 7th, right?

A: Yes.

Q: Is it reasonable to say that the time when ROCKWATER 2 will be leaving Pier 1 is going to be around the same time, on the same day?

A: Yes.

Q: .6th or 7th.

A: That's correct.

Q: And once you bring back to the shallow water area, you estimate that you get here (inaudible). You start right away, or...

A: No. That's a very good question.

When ROCKWATER brings EHIME MARU into the shallow water site there are several things that have to happen. When we set the ship down, the incline of the shoreline at that point is about a six-degree angle down towards the ocean. We will be sitting the EHIME MARU starboard side to the beach, which means that the ship will take about a six-degree list to the port side, the opposite of where it is right now.

Once we have set the ship in place we then have essentially a safe period, about 24 hours, to allow the ship to settle and ensure that it is stable in that position. At that point we will send divers down to do a preliminary inspection of the exterior to ensure that there are no obstacles to our ability to continue the operation.

During that next 24-hour period of time they will start some topside debris removal to clear access paths for the divers to safely enter the ship.

That second 24-hour period will be primarily preparation for the divers to gain access. It will be after that second 24 hours, or roughly 48 hours from when we get the ship in place when our diving operations will start, and obviously that is contingent upon getting the barge, the Crowley 450, into position, that it is prepared and ready to go.



And I want to emphasize here, as I have done before, safety of the people involved in this is the primary driving factor in what we do. So if we find ourselves in a position that we're not ready to begin diving at the end of 48 hours, we will not. It's not worth risking lives at this point. We do not wish to endanger anyone's life in this operation.

So roughly 48 hours is the plan. Weather is always a driver. If the sea state is supportive, we expect in 48 hours to be over the shallow water site.

Q: How would you recover the remains from the ship? Do you (inaudible)?

A: We will be prepared to forcibly enter compartments if we have to. With the assistance of the Master of KAGAWA MARU, the sister ship of the EHIME MARU, several weeks ago our divers were able to go on board and videotape accesses to all of the compartments that we will have to get into. Those access paths that they were able to lay out have watertight doors topside, they have ladder wells that we'll have to traverse, and they have non-watertight doors somewhat similar to the kind of doors we have here that close compartments. As the ship bends and twists, some of those doors may be jammed in the closed position so we may have to forcibly enter those compartments. We're prepared to do that.

Q: Are you reasonably sure as to where you'd find the members?

A: We have a plot of where the crewmembers were last seen when the ship went down, so we will base our search pattern on where those seamen would have proceeded to from that point. So we have a pretty good idea where they all were and a pretty good idea of where they were headed to. So we're pretty comfortable with what we have.

Q: Are there any concerns (inaudible) that the Navy's (inaudible)?

A: I would tell you this. There is a considerable cultural difference between the United States and Japan. Most of those cultural differences are rooted in religion. So there are most definitely differences in the way we do things and the way the Japanese do things.

In the course of this operation we have attempted to understand the Japanese culture and educate our divers and the folks that will be working on the bottom to respect that culture, and to the best of our ability we will do as the Japanese would have done themselves.

Q: Has there been a request by the Japanese to...

## F/V EHIME MARU Recovery and Relocation Report

A: No there has not, specifically. We know that the families are anxious to reclaim remains because of their culture and their religion. Those remains mean a lot more in their culture than they would in a Western civilization. A burial at sea is a very honorable location for most particularly seamen, but in the cultural arena that we're dealing with it's very important to recover those remains.

How the remains are handled, how the remains are recovered, how they are transported, there are many cultural differences that we've had to become educated on to be able to handle those in a respectful manner.

Q: How many (inaudible) people (inaudible)?

A: There were nine souls aboard EHIME MARU that were never recovered, and by the placement of those individuals as they were last seen, we have probably a fairly strong likelihood that some of them are not on board the ship. My expectation is that that number may be five or seven. So there is a distinct possibility that several are lost at sea.

Q: (inaudible) removed and where do you have (inaudible)?

A: We've removed two masts from EHIME MARU. We've moved the forward mast and the mid mast. I'd just point out the forward mast essentially was removed intact in one piece. The main mast which had the radar equipment and electronics equipment on board was severely damaged during the descent to the bottom. The extreme pressure caused the mast to collapse, and as a result, the removal process was very difficult and that mast was in fact destroyed in the process.

So today we have one mast intact and we have one mast in pieces. Both of them have been recovered to the surface and both of them are currently in a safe storage location at the Pearl Harbor Naval Shipyard.

Q: (inaudible)

A: The main mast was destroyed.

Q: (inaudible) you mentioned five to seven. (inaudible) still in the hull, or five to seven...

A: No, I think five to seven are probably still in the hull. There is always the chance that we will find all nine, but I think that realistically given the locations of some of those seamen,

they would have been en-route to exterior locations and may very well have succeeded in getting out of the ship but did not survive the sinking.

Q: What area of the ship do you think they may be in?

A: Well, I will just tell you that some of those folks, probably the majority of them, were down deep in the ship on the third deck. And several were located on the first deck and up to the pilothouse. So the majority down low in the ship.

Q: Is it reasonable to assume that the major hurdle here in this operation is the actual initial lift? There is a chance that it will not survive that initial...

A: You're absolutely correct, and I think that is perhaps the single point where the risk is the greatest. Once we've lifted the ship, if it survives that initial lift then the structural integrity is probably at least close to what we estimated it would be. Once we have completed an assessment to tell us that the ship is structurally sound, then I think the probability of success in moving it goes up dramatically. But as I said, we've characterized that at this point as probably a risk of about 20 percent that there's greater damage there than what we had anticipated.

(END)

# Meteorology, Oceanography Press Conference

CPF HOME EHIME MARU RECOVERY NEWS

## U.S. Pacific Fleet Public Affairs

---

PEARL HARBOR, Hawaii (Aug 15, 2001) -- Capt. Ty Aldinger, Fleet Oceanographer, Pacific Fleet, Capt. Tim McGee, Commanding Officer of the Naval Oceanographic Office, and technical experts (Dr. Michael Carron, Mr. Rick Myrick, and Lt. Junior Grade Ken Ingram) representing the Navy will provide media an operational overview of meteorological and oceanographic support to the EHIME MARU recovery at 1 p.m., Aug.17. Following the brief, the Captains and experts will lead tours of the USNS Sumner (T-AGS 61), a multi-purpose oceanographic survey ship operated by Military Sealift Command for U.S. Navy.

Sumner has provided on-scene support to the EHIME MARU recovery operation completing a bathymetric survey, deploying current meters and TABS (Texas Automated Buoy System) buoys, collecting ocean sediment samples, and conductivity/temperature/depth measurements. During the movement phase of the recovery Sumner will accompany ROCKWATER 2 to the Shallow Water Recovery Site, providing real time current information.

This event is intended to familiarize the media with how oceanographic and bathymetric data was collected and used in the environmental assessment and recovery planning as well as how real time meteorological and oceanographic support will be used during the operation.

Tour of SUMNER will be broken into two groups one for print media and the other for broadcast. Meteorology and oceanography experts will lead each group and be available to answer specific questions regarding support activities.

Space on board SUMNER is limited, so interested media must contact the Pacific Fleet Public Affairs Office at (808) 471-3769 no later than 4 p.m., Aug. 15.

SUMNER will be moored at Aloha Tower Pier 9.

Rundown of Schedule:

Aug. 16 (Thursday)

4 p.m. Deadline to register for brief and tour

Aug. 17 (Friday)

12:30 p.m. Press should arrive Pier 9 Aloha Tower

1 p.m. Meteorology and Oceanography brief begins

1:30 p.m. USNS SUMNER tour begins

## Salvage Supervisor Updates Media

CPF HOME EHIME MARU RECOVERY NEWS

### U.S. Pacific Fleet Public Affairs

Videotaped brief and interview with Capt. Bert Marsh  
Also see corresponding presentation slides

---

Aug 22, 2001 -- Marsh: As was mentioned, my name is Bert Marsh, and I'm the Supervisor of Salvage for the U.S. Navy. I've been involved in the EHIME MARU project recovery effort basically since back in February shortly after the disaster. I came out and helped in the initial search effort. One of our ROVs helped in the initial finding of the EHIME MARU. I've been involved in the feasibility study that was conducted. I followed up with developing the salvage plan, and now I'm out here with the ROCKWATER 2 in going through the process of executing that plan.

Why I'm here really is to explain to you where we're at, where we've gotten in the last two weeks, and why the ROCKWATER 2 is currently sitting at Pier 1 down in Honolulu.

If you take a look at this poster right now, we've stolen it from the Honolulu Advertiser, this is really a compendium of the entire process -- the salvage plan that we developed. What you see in here is the first step, trying to pass underneath, messenger wires underneath the hull of the vessel. What we have right now is we've had difficulties in getting the messenger wires underneath, so we are going to a slightly different method to pass those messenger wires.

In the salvage business there is a standard saying, essentially, and that is that whenever you go to do a salvage job you always try to bring everything you can imagine you would need. When you get to that point, then you take about 50 percent more in order to make sure you can do the job when you get there. So in that sense we have come with an extra planned method of passing those messengers. That's what I'm going to explain to you today is the process of how we're going to pass the messengers -- slightly differently than we planned originally.

Take a look at this next poster right here. What you see is vice the idea of the coil tube drilling, passing the messengers for us, what we're going to do is put another lifting swing on board the ROCKWATER 2. That lifting swing will be passed under the stern of the EHIME MARU and we will physically lift the stern up enough so that we can pass messenger wires underneath here.

This chart also shows you that what we will be doing is, what we have done already prior to coming in, was we have placed a number of what's called clumps, which in diver's parlance simply means a heavy weight that we use to establish a descent line, so that when you go on a diving operation you go straight down and you're right where you want to be and you're not off some place else. The clumps act the same way. They establish a position on the bottom of the ocean.

We had several clumps. These two right here initially were behind in these positions. They have been moved. What we're doing is moving them into a position so we can actually pull on this stern lifting plate. The stern lifting plate will be loaded out in the next day and a half, two days, while the ROCKWATER 2 is in port. We will marry together, put together a fitting that actually goes on the end of this, a very heavy metal fitting to go onto that that can be made up on the bottom of the ocean. That's the process right now.

We've been out there trying to position all of these clumps for quite some time. I want to give you a perspective, if I can, on why that's so difficult. One of the guys out on board the ship, as we were trying to position these clumps... You've got to understand, these clumps have to be lined up essentially perfectly perpendicular to the ship. The entire design of all of this cradle is predicated on the idea that the [strap] will come up just exactly where we planned down to what's the length of that wire. That length has to match up with where that frame comes down. If it doesn't, then we've got a real problem. So you have to have the slings in the right place. They have to be perpendicular. A good analogy somebody came up with on the ship was that if you're trying to put those clump weights down there at 2,000 feet, at the bottom of the ocean, if you put yourself on top of not just the Empire State Building, but took another Empire State Building and put it on top of you, climbed to the top of both of those, took a fishing line with a typical little fishing weight on it and tried to cast it off, come down to the sidewalk below and hit a six inch by six inch block. That's what they've been trying to do out there. Put those in that kind of position. And oh by the way, the building's moving all the time. To give you a little perspective on the operation and why it takes so long.

So in essence what we are doing is shifting gears slightly and we're going to use a very well proven method for passing slings underneath a vessel, and that is to lift her at the stern and pass messenger wires underneath the hull.

As I mentioned before, the fittings that we're going to be using and that we will be installing on the main lift wires -- and this is a difference. I'll explain it in a couple of minutes when I show a slide that shows the frame and how we will be using the cranes on the EHIME MARU as opposed to the lift wires, the large wires, what we call the fat wires -- 115

## **F/V EHIME MARU Recovery and Relocation Report**

millimeter, 4.5 inch wires. We will actually be using those wires to do this stern lift. And there are fittings down here that go together that have to be made up at depth, meaning that the ROV has to put it together down there.

Now those fittings are purposely designed for deep ocean work. The company's name happens to be Delmar. But what they do is they have come up with ways to make this fitting, this one right here, is actually buoyant so that it means that it stands proud of or off of the bottom. It literally is standing up. It's not too buoyant to float up on us, but it's just buoyant enough that it will be up off the bottom. That will allow the ROV to guide in this piece into that piece and close a bale over it.

Now when you're trying to do that with an ROV at 2,000 feet, one of the ROV operators came up with a little analogy. If you think about, if you're trying to do something in that kind of situation, go get your, any of you that ski, snow skis.

Take some snow ski mittens where you have no fingers, your hands are all together; take those, close one eye, and sit down -- oh, by the way you're at 60 atmosphere besides -- and try to thread a needle. Think about trying to do that. Especially with your eye closed, once you lose your depth perception. That's what they will be doing down there, making that connection up. They are designed specifically for ROVs working on the bottom, so that's why we've got them already.

Next one.

As I mentioned earlier, basically we will be using the fat wire or the lifting wire to do this. This is a change from the way we originally thought we could pass the messengers with using what we call the coil tube. What we will be doing is hooking up the lift wires themselves and picking up on the stern and then passing a messenger underneath.

Ultimately that messenger will then help us pull the plates through, the lifting plates themselves. The lifting plates have to go through, if you were at the first press conference or looked at it, basically you have to go through end frame 61 and frame 15. Sixty-one is the one that's up near the pilothouse. If you went straight almost down from the pilothouse, that's frame 61. Back in the stern area in the engine room, that's frame 15. And as I mentioned earlier, we have to line those up essentially perpendicular to the hull and in the right spot.

Next one, please.



Though we've had some difficulty working the messengers or working the coil tube drilling under, the sub-sea system pump that we have used has been very effective out here. We've been able to pressurize seawater and press it through and actually dig holes with it very easily.

So what we will be doing is using that same sub-sea pump that we will place on the bottom, and it will have a connection on it. I have the pump drawn here. But there will be a connection from it into the sling as planned before; the slings will then have jenny nozzles on them. So we will be pulling from the surface with a crane on the messenger, and jetting at the same time to pull the straps through. These are the lifting straps, the metal straps, which you probably got a chance to see if you toured the barge earlier.

This essentially shows the same thing, from a stern perspective. What we will have done is steer ourselves into a position where the messenger wire has already been passed, and then we will be bringing the lifting plates into play with the crane. We will be pulling up with the crane on the messenger, pulling the plate through, and also jetting at the same time.

So that's the process that has to go on, and those are the next major steps we have to go through. Let's go on to the next one, please.

Once we have the messengers passed and the plates in place, our next step after that, in fact what you will probably see is once we have that done, that completed, that step completed, we will be returning to port again with the ROCKWATER 2. At that time what we will be doing is bringing this [lift fork] up, the frame, and the bottom frame together. We'll be marrying them together while we're actually in port. We'll start pier side to get the top frame all rigged, then we will go out to the shallow water site that you can see from the top of this barge, and put the bottom frame into it. Once we get all that together we have about, in the air weight that's about 101 tons all told. So we will be suspending that beneath the ROCKWATER 2, and get underway for the deep-water site at that point. Arriving back out there we have to lower it all down, disconnect the top and the bottom frames and reposition it... We'll actually lower it down outside of where the EHIME MARU is. This part right here is about 10 tons buoyant, so it will float above the EHIME MARU. At that time we will with the crane move it over, and then we have the straps to make up. Once those straps are made up and you come back down with the top frame, marry that back together, and again the ROV has to do a specific job right there, torquing a pin back in, actually marry the top frame to the bottom frame.

At that point we're ready to lift. And there we'll be into the situation of looking for the right kind of weather to lift in.

## **F/V EHIME MARU Recovery and Relocation Report**

That's getting a little bit ahead of it. The next step for us, as I say, is getting the messengers passed and then the lifting straps through. You should see us back in port after that. We basically determined that that was going to be the best way to do this next step. I would think that the next time you see me we'll be somewhere back into the idea of doing the frames, putting the frames together.

That's about all my remarks. We still look to be doing the lifting in mid-September. That's still our plan. Weather is going to be a factor and we'll have to see how that plays out.

I think as you've called and talked to the PAO people, the process will be event-driven. There are certain milestones we have to reach. As we reach those milestones the PAO people will know it and they'll be advising you of where we're at as we go through it.

That's about it. I'll go ahead and take questions.

Question: The main difference between what you were doing and what you are doing. Before you were not going to lift the ship at all. You were trying to drill underneath the ship and place the straps doing that, correct?

Marsh: That's correct. This method using the coil tube drilling.

Question: So then why the need for the lift at this point? What made you say we can't do it like this. We're going to have to lift the stern.

Marsh: Essentially the coil tube drilling was the first application of that technology in this situation. We did some testing ashore. However, it couldn't exactly duplicate what we saw at sea, and we have sort of a time limit on ourselves, that we can't go forever trialing something. So we went ahead and made the decision that we would transition into this other method of lifting the stern. It is very much a proven method in salvage. They did tell me, I should have told you something about my salvage background and I guess I blew right by that, didn't I?

I've been doing salvage for 25, 26 years. The last one I did was... The first one I did was a job off of Kaneohe, actually, here, picking a tanker off there in 1975. So I've been involved with the Exxon Valdez, I directed the Egypt Air / Alaskan Air, some of our work on the USS Cole. I was in the Persian Gulf during the Gulf War, got flown out to the Princeton for her salvage and stuff, so I do have quite an extensive background in salvage.

Question: What risks are involved with this? Why didn't you suspend it the first place?

Marsh: The principal risk is that you tend to stress the hull more than you would if you can pass the messengers. However what we found... When we came out to do our initial assessment with the ROVs, at that time... This picture really shows it from that standpoint. At that time we had the forward mast up, we had the middle mast up, we had guide wires going back and forth between them. So we weren't able to fly our ROVs down into this deck area very easily.

This time around, one because we have three ROVs out there. We have one of them that's smaller. We actually put it on the deck right here. So we have a better feel for what the strength in the hull is, one. Two, we have already dug a considerable amount of sand out from underneath the vessel. And essentially, three is we are combining the two methods because we are still going to be using the water jetting technique to help us pass those under. So we have a very short timeframe that we will have to lift to stern. Initially the plan was that if we were unable to use the sub-sea pump, if we had some problem with that, then you would have to lift the stern all the way up and keep it up until you passed the actual straps, not messengers. There's quite a difference between bringing a strap that's almost five foot wide, a big piece of metal, underneath the ship, as opposed to a small wire.

So what we're doing is we sort of combined the two a little bit. We will still be using the sub-sea pump to help us jet underneath with the straps.

Question: Can you elaborate on that? You said you would continue using the jetting. The jetting will be used when you've raised, I assume you've raised the stern of the ship enough to get the wires. What then is the purpose of continuing to use the jetting technique?

Marsh: At that point we can let the vessel back down. We do not have to hold it while we get those large plates underneath. That's what I was trying to explain. It's a difference of if you pull this diameter wire through there as opposed to a plate that's this thick, there's much more friction that you're going to be opposing. So we're going to be jetting through those plates actually underneath here. But we can set the vessel back down when we do that.

Question: So the jets are going to be used just with the plates and not with the wires.

Marsh: Correct.

Question: So how long will the vessel be lifted up then?

Marsh: I can't really tell you that. That would be a total guess from that standpoint. We will try to keep it as short as possible, but...

## **F/V EHIME MARU Recovery and Relocation Report**

Question: Is that hours or minutes?

Marsh: (Laughter) It will be in the hours, yes. Probably.

Question: Explain a little bit what happened with the coil drilling that made you conclude that it wasn't working, (inaudible).

Marsh: We were actually very much able to drill with it. We were able to poke holes a lot. But the issue is trying to get the coil tubing to go down under the EHIME MARU and come up where we want it. To turn again and come back up. Essentially what we think is we have a little softer soil that didn't support the curvature coming back up again. But that's somewhat supposition on our part. As I said, we did a test in Houston, Texas, but that was ashore, because we didn't have all the sub-sea equipment put together yet at that point.

Question: I think you had contingent plans originally.

Marsh: Yes, we did have a... In any salvage operation if you can come up with alternatives you do that. Knowing that Mother Nature, the weather...

Question: What I want to know is, are there any differences between the original contingent plan and this time, other plan.

Marsh: The only difference is that as a contingency we had initially planned to lift the stern and pass the entire strap, the metal strap all the way through with the stern up in the air. In fact we now know that we have a very effective means of using the sub-sea pump. Those work very well. They're pushing a lot of water through. We can vary the pounds per square inch to push basically, the pressure that it will push all the way from somewhere around 300 psi up to the 1400 psi. So we know that works and it works quite well.

With that then we know that we can go ahead and connect the hose up to the straps and use that method to get the straps underneath. So we have combined the two.

Question: In the last press conference you told us that you estimated that the probability of success was 80 percent. What is the probability of success now?

Marsh: We are still at 80 percent.

Question: Are there concerns about conserving a portion of the ship where (inaudible)? ...the ship's integrity?

Marsh: I don't see that kind of a concern because when we do lift the ship. In this case we will be lifting here a very small amount. We don't need very much to be able to snake a wire underneath it. So no, I do not consider that a specific problem from that standpoint. When we do lift the EHIME MARU the plan is, and it's what's generated in the environmental assessment, we will be picking her up and waiting for a period so that we can do a full ROV up close and personal camera view of all the damage that so we have a good assessment of what strength remains in her hull, and also if there are, unfortunately, any remains that would happen to come out, we will be prepared to recover at that time. That's part of the plan.

Question: Just as a follow up. You lift the stern. Can you tell us approximately how far, approximately how long if it's just a few hours? And also just clarify the idea is to just put the wires underneath, correct?

Marsh: Uh huh.

Question: And before the wires were going to be placed using the copper tubing pump?

Marsh: The coil tube was to drill its way to the other side of the vessel and come up. Then it had a head arrangement on it so you could attach wires to it, then you would pull that copper -- it's not copper tubing, it's actually coil tubing steel that will withstand 10,000 psi. Very, very solid tubing. That would pull back and bring the messenger wires through. But since we can't, it isn't out the other end so we didn't attach the messenger wires. We've transitioned to picking the stern up and then run the wires through. We'll be running the wires through with the ROV.

No, I can't tell you right now exactly how high we're going to lift that. It all depends no how much sediment we get. When we're doing work out there right now what we're running into a lot is, there's very minimal current, at least most of the day on the site. So when you disturb anything the silt basically sits up for half an hour or 45 minutes -- you can't see anything. It's just a blind, blur of brown on the screen. You have to wait until that clears enough so that the ROVs can see what they're up to again.

Question: Do you expect any delays in this?

Marsh: We still think we'll be in mid-September, and as I said, I can't get any more specific than that because the weather at that time will dictate a lot to us.

Question: So you've kind of calculated into the timeframe perhaps changing methods?

## **F/V EHIME MARU Recovery and Relocation Report**

Marsh: When we came up with our alternatives we looked at that option. So yes, we knew the option existed and we have an idea how long it's going to take to do it, so we still think mid-September sometime. I can't be any more specific than that.

Question: Why are you lifting the stern? Why won't the other...

Marsh: We lift the stern basically because what they call the frame zero, which in naval architect parlance means the, here's another naval architect term, the after-perpendicular. That's one of the strength parts of the ship. Very strong part of the ship, which is why we go there.

Question: Do you think of this alternative method as a setback in the recovery operation?

Marsh: No, I don't. No, I don't. It would be had we not had an alternative ready to go. Yes, it would be. However, we had come up with an alternative and right now we have all the equipment we need on the island already and it's just a matter of swapping out. We did not have the capability to carry all of this alternative equipment for this method out with us because we were simply full. If you got a chance to see the ship as she pulled out the first time, there was hardly any place to walk on the deck, much less put any large equipment like the lifting strap that has to be put down.

So we left all of that in port. We've transitioned. We're going to come in and rig some of that, put everything else on the ship, and we'll go to sea with it and attempt to pass the strap.

Question: A couple of days?

Marsh: Right now we expect to go to sea in a couple of days, yes.

Question: You came back in port when?

Marsh: I think they came about 10:30. Pier 1 in Honolulu.

Question: In the initial plan you were going to have the messenger wires coming back through pulling back through to pull the lifting straps back through?

Marsh: Yes, and we will essentially still be doing that part once the messenger wires are underneath. Those messenger wires are there to be able to give...

If we go to... This will give you the picture.

Once the messenger wire is underneath essentially, we can set her back down. Then we will be pulling on the plate with the crane at the same time that we're jetting. You've got the force of the messenger wire, the crane pulling; and at the same time you're jetting.

Question: ...the height of the lifting ship. Your drawing that's underneath there, I believe. I just want to make sure, that drawing shows the ship being lifted at a pretty strained angle. That's just...

Marsh: That's just for the illustrative purposes, yes.

Question: Just very slightly lifted?

Marsh: Yes.

Question: May I understand the reason why drilling cannot go through is because the bottom material is too soft? Is it not that you hit a hard part or what is the reason?

Marsh: The reason, we think, and we don't have the opportunity to experiment. We don't really want to spend the time out there experimenting. What we think is when we have tried to turn the tube we have either been able to hit the hull of the EHIME MARU or we have gotten out past that and the tube, instead of continuing to turn actually bent back over again. So it went out straight.

We've actually had at maximum somewhere in the neighborhood of about, almost 200 foot of tubing out, which means it went out under the EHIME MARU, stayed under the surface of the ocean bottom, and went straight on.

We do know that we were able to go straight, but it's getting it to do that last turn all the way up again. We were able to actually have it turn on itself in the air. Sitting with the barge that we brought this equipment out on, out at Victor Piers here in Pearl Harbor, we ran the coil tube out and actually had it bend back on itself. That was in air.

Question: Then are you...

Marsh: I've got to get back to the ship, and I thank you very much for your attention.

(END)

## TRANSCRIPT: Update by Rear Adm. Klemm

CPF HOME EHIME MARU RECOVERY NEWS

### U.S. Pacific Fleet Public Affairs

---

Sep 6, 2001 -- "Good afternoon, ladies and gentlemen. We appreciate you all gathering here on relatively short notice, but we felt this announcement was an important one, and I wanted to personally brief you on the status of our operation today and give you an indication of some coming events.

"As you have known from following the EHIME MARU recovery effort, we have had some snags along the way, our plans have been very specific and in a number of cases we have been forced to deviate from those plans – not an unusual set of circumstances in an operation that is as complex as this, or in any salvage-type operation, for that matter.

"These setbacks, as you may recall, include our inability to properly execute the drilling underneath the ship, scarfing up cables under the ship to place our cables, and to some degree, the partial lifting of the stern to install the lifting plate.

"I will tell you that these do not represent failures, but they represent learning experiences which have resulted in innovative approaches to the way in which we will execute the rest of this recovery operation.

"I am here to tell you that the United States Navy is firmly committed to the execution of the recovery of the EHIME MARU, and nothing that has transpired to this point makes that mission any more difficult than it was from the beginning.

"The experiences that we have had at this point tell us some good information with regard to the structural integrity of the ship. The ship is in much stronger condition than had been initially anticipated in the feasibility studies. It has been able to withstand far greater structural stresses than were calculated initially. That is a very good sign, and a very positive sign for our ability to successfully relocate the ship.

"At the same time, our exploration of compartments on the ship – opening of spaces, compartments and hatches has indicated that the amount of petroleum products that remain on board the ship is significantly less than we had initially anticipated in our environmental



assessment, and in fact were well below the 10,000 gallons that we had previously estimated at the last press conference.

"The ship today is resting down by the bow, as it was previously lifted by the stern. It is nearly upright, with less list than it previously had. It is in an ideal situation to install the after lifting straps, and that will be our next mission area.

"I would like to state that myself and the team of Japanese experts, U.S. Navy experts and contractor experts have reviewed the calculations and the operation, and we are more confident today that we will be successful than we have been at any point in this operation.

"Plans are being finalized as we speak for the very specific steps that will be taken. Captain Bert Marsh, the Navy's supervisor of salvage who has addressed you at previous briefings, will speak tomorrow in this same location at 12 noon Hawaii Standard Time to provide a detailed description of how the rigging will take place. The rigging has not substantially changed. Some of the sequence has changed, but the ultimate rigging is in fact in accordance with the original plan. So once we have recovered to the point that we have attached the two primary lifting straps to the ship, the remainder of the operation will be the same as you have been previously briefed.

"As you know, ROCKWATER 2 came into port to offload some equipment and onload additional equipment to continue the operation. She will be getting underway at 1800 local time this evening for a fueling stop with a scheduled underway at 0200 in the morning tomorrow to return to the deep water site to continue the operation.

"In closing, I would simply like to say that in any salvage operation, there are more unknowns than there are knowns. And those unknowns require innovation. There has been a great deal of innovation throughout this operation. We have the very best U.S. and Japanese salvage expertise brought to bear on this project. Our prime contractor, Smit-Tak and their Haliburton team has brought unprecedented expertise and equipment to bear on a project that has never before been undertaken.

"Cooperation between the United States Navy and the Japanese Maritime Self Defense Force could not be better. We have all of the tools, the necessary personnel and the willpower to successfully execute this mission, and that is exactly what we intend to do.

"Thank you very much, and tomorrow if you will, please allow Bert Marsh to give you the specific details of the changes in the operation." This is an official U.S. Navy web site.

(END)

## **TRANSCRIPT: Update by Capt. Bert Marsh**

**CPF HOME EHIME MARU RECOVERY NEWS**

### **U.S. Pacific Fleet Public Affairs**

**Director of EHIME MARU Recovery Operation ocean engineering  
POWERPOINT SLIDES**

---

Sep 7, 2001 -- "As was just mentioned, my name is Bert Marsh, I'm the Supervisor of Salvage. For many of you that were here before, I talked about my background a little bit, but just to remind the ones that weren't here before. I work out of the Naval Sea Systems Command in Washington, D.C. I've been involved with the EHIME MARU recovery effort basically since early February, shortly after she went down. I directed the operation to come out and do the initial search for her. After we found her, I then went back and went through the feasibility study. And at that point we decided we believed we could raise the EHIME MARU. From that time on basically I've been intimately involved in the process of getting all the equipment here, all the logistics, and now I'm out on site. As was just mentioned, I've been on the ROCKWATER 2 since she arrived, and been out on the site directing from the Navy side.

What I'd like to do first is report back to you that the entire group of people out there, which is a crew of international experts in salvage and the structural side, remain fully committed to the recovery of the EHIME MARU. Lifting her from where she's currently at and bringing her into the shallow area where, as you've already met the other team of divers who will be doing the actual recovery.

We've had a couple of small issues, and where we're going has slightly changed or modified our plan. It's really an evolution of our plan from that standpoint. That's really what I'm going to show you.

Our previous efforts talked about lifting the stern and passing messenger wires. The messenger wires would be used to pass the lifting straps or plates -- they're actual plates that have wire backups to them.

Where we're at right now is we're in a position where we can and are in fact doing right now, passing the after strap into position at Frame 15. So we have gained to that point.

As a result of our efforts, however, what we've ended up with, we actually lifted the vessel for a total of almost 40 hours. In that effort, as I say, we were able to get the after messenger wire in position, but we were not able to get a messenger wire passed forward.

So her current position... To clarify messenger wires. This messenger wire, as I'll show on the next slide, is already in position, and we're currently getting the stern plate ready to put into position.

As a result of lifting the vessel for, as I said, in excess of 40 hours, we have essentially changed her attitude. As she sits currently out on the sea bottom right now, what you'll see is she is up by the stern. We had this messenger wire passed and the ROCKWATER 2 is on-site right now and will be placing a lifting plate at Frame 15. I'm going to show you that on the next one.

Her rudder is 22 feet, a little over six meters, off the bottom which makes it simple as far as passing the after strap.

The problem we're presented with now is that by lifting her and maintaining her up, we have in fact put Frame 61, which is where we want to put the other messenger, partially in the mud, so we have to overcome that. What we're going to do... Well, go back a second here.

What this really shows is a couple of things. One of those is that the back, that the vessel will now sustain itself in this position, that's caused by two things, or tells us two things. One of those is that we have more strength in the bow area than we initially anticipated.

As I talked to you about the feasibility study, when we conducted that feasibility study we were looking at initial photographs of the vessel taken by an ROV back in February that showed that there was some damage to the side shell in this area. With that we did our calculations all based for strength of the vessel, essentially the bow of the vessel, we did those calculations all based on assuming that the side shells were bad and possibly the deck above it was bad, would not take any load.

In fact because we've been able to lift her or maintain her in that angle for so long, we now believe that we have more strength in the bow area, which is why the Admiral in his comments yesterday said we were more confident in our ability to ultimately lift the vessel and transport her.

Next slide.

## **F/V EHIME MARU Recovery and Relocation Report**

Where we stand right now, as I said, the ROCKWATER 2 is on site. She is in the process of passing this after lifting plate into position. That lifting plate actually is a steel plate. It has wires underneath it as reinforcements, and that will be at Frame 15.

You see a small wire strap right there. With the vessel in this attitude we have to have a retaining strap that holds that lifting strap in place, keeps the lifting strap from sliding down the vessel.

At the same time that we are placing this, we're also going up to the bow area with our ROVs and starting the process of dredging out the bow area so that we can get at what's called the anchor hawse pipes. Those are what we're going to use to lift the bow of the EHIME MARU in order to get the forward strap in.

Once we have dredged the area of the bow in order to be able to get at the anchors and actually cut the anchor chain with the ROVs, we will then recover the anchors either back onto the ROCKWATER2 or we'll place them onto the EHIME MARU, one of the two. So that they will be recovered.

Once they are out of the way, though, we will be rigging this sling arrangement that we'll use to lift the bow of the EHIME MARU. That will allow us to place the forward strap into position. It will go on here in a couple of seconds and it will become a little more obvious how we're going to do that.

Next one.

What we are doing is taking advantage of the previous arrangements we had made as far as a lifting frame are concerned. We designed the lower lifting frame which is this part in green to be buoyant, meaning that it will in fact float. These weights right here, these blue pieces, are clumps that actually hold that down into position. We will take advantage of that buoyancy when we actually transfer a single lifting point out to the bow.

The lifting sling I showed you previously has a fitting on it, a specialized fitting called a delmar fitting. That is used to make a connection in a deep sea situation where the ROV has to make the connection. We're talking capabilities, the delmars will hold in excess of 300-400 tons easily. So it's very massive piece of equipment. They're designed specifically around the idea to make it easy for an ROV to make that connection up underwater. We've actually made that connection several times in our placing of the stern strap area.

So we will be transferring from what, this is called a delmar connection – female side and the male side, we will be transferring over and actually picking up the bow using what we've already designed. So the process really is an evolutionary one.

We've modified our previous process using the equipment we have. Obviously we had to sit down and do all the engineering calculations. I mentioned also that we have two members, two Japanese individuals on board who are structural experts. One of them, Dr. Fuji, is actually from the building yard, Kodashiba. He has evaluated our plan for us. In fact he advised us specifically in how we would design these plates. Those plates essentially are called backing plates. The size of those plates determine where you distribute the load as you're picking something up. If you're trying to pick from a single point, you can cause failure there, but if you spread that load out, so the design of those plates was something that in fact Dr. Fuji and Mr. Takamoto helped us with.

Next one.

Once that's done we will then be in a configuration where we have a single lifting line. This is actually one of our linear winches coming down to lift the bow. We'll have a doubled up linear winch on the stern. We will be pulling from the hawse pipe area, lifting the bow up, lifting the stern. Initially it will be to lift the bow. As you saw, her attitude is like this. We will initially start lifting with the bow. As she starts to come up we will start picking up loads in the stern area. At that point we will start lifting on the stern.

The entire purpose of this is to get it out of the hole that she's currently in so that the bow is open and acceptable to pass the actual permanent forward lifting strap.

Next slide.

As the bow line that you saw here is depicted here, it's really a temporary measure in order to be able to get the bow up far enough so that we can pass the permanent lifting strap into place. That process will mean that we will ultimately pull up on the bow once we... We're going to move her out of the hole she's in, set her in a level part of the sea bed close to where she's at -- we're not going to move her very far. Then we will lift the bow again and place that forward lifting plate.

The rationale for picking it up twice is very simple. That forward lifting plate has to be exactly positioned. We have to put it in the right orientation perpendicular to the hull and at the right position as far as the frame spacing is concerned.

## F/V EHIME MARU Recovery and Relocation Report

So what we will do is set her down, put in place clump weights on either side of the EHIME MARU. This is part of the original plan. Those clump weights will be used to guide that plate through. But they will be put down in precise locations. One clump weight allows you to pull with the crane; the other clump weight actually allows you to have a backing strap that helps you position it exactly where you want to.

That's the process that will go on. We'll go ahead and put this sling in place, then we will set it back down.

At that point we'll be ready to disconnect the bow. ROCKWATER2 will then proceed back into the shallow water area where we will re-rig this top frame. If you noted in the earlier pictures, we were talking that we were actually rigged correctly in the stern one for the after part of the top frame with the double wire. We now have to come back into port. The shivs right there, those [shivs], you saw them on the barge earlier. Those shivs are about two times the size of a man from that standpoint, so they have to be handled very... They're very difficult to handle. So we will be pulling back into the shallow water area. We will actually suspend this beam below the ROCKWATER 2 and then proceed back out to the site.

At that point we're back into our planned evolution of bringing down the top frame into the bottom frame.

Now we have confidence in the fact that we can move the vessel that short distance with the bow because we have been able to lift her and maintain her up using what is called the dynamic positioning system on the ROCKWATER 2. What that means is, it is a system that takes input from the GPS system, the satellite up above. It takes that into consideration as to figuring out where the ship is on the ocean. It also reads wind effects on the ship, the current effects on the ship. Those are all put into a computer. The computer turns it around a little bit, and the next thing you know the thrusters are acting to null out or cancel out the effects of the wind and the current.

What we've actually been able to do in this situation is with the dynamic positioning system of the ROCKWATER 2, while we had it lifted for almost 40 hours, we were able to maintain position. So we have added another variable to the dynamic positioning system. You don't normally end up with a dynamic positioning system operating while you are essentially moored in 2000 foot of water which is what we were when we were tied into the EHIME MARU.

So we're confident that when we lift we'll be able to safely move her over, set her down on a level portion of the sea bed close to where she's at, then relift the bow just enough to be able to pass the forward strap. The reason we're doing that is to have those... Those are the

permanent lifting arrangements. Those are what will be used to both lift her, transport her into the shallow water site. They remain with her throughout the time the divers are conducting their searches. And at that point basically they will be used again to lift the vessel and take her to her deep water site. So that's the permanent arrangement.

What we're doing is a temporary arrangement of lifting the bow enough to get it out of the mud so that we can pass that strap and then move to the beach.

With that, I think that's about all I have. I'll go ahead and take questions for about 15, 20 minutes if you'd like.

Q: How many (inaudible) new (inaudible), how many (inaudible) new vessel?

Marsh: We have incurred some additional timeframe in the fact that we have to do some dredging. That shouldn't be a major delay. To try to get too specific with you, I really can't do that right now.

We have purposely described this event as a milestone-driven event rather than a schedule-driven event, and we need to stay at that pace from that standpoint.

We have safety as our paramount concern out there, so weather effects and other things can fall into it, but trying to give you an exact date is really a little too premature on my side.

What we will do is inform you as we reach the major milestones.

Our next major milestone will be when we have dredged and are ready to lift the bow

Q: Given that you had (inaudible), are you able to give us, I know this might be difficult, a kind of rough percentage, a success rate (inaudible)?

Marsh: This remains a very difficult operation. I don't mean to make it appear like it's just simple, we just switched plans and we can move on from there. However, we do have flexibility in our plans and that's allowed us to move on to this method where we are, because that, as I mentioned, the top or bottom lifting frame is buoyant, if that hadn't been we would have a major problem on our hands. But we don't from that standpoint.

So I still remain very, very confident. I think we will lift here. I don't really want to change the numbers from that standpoint because...

## F/V EHIME MARU Recovery and Relocation Report

What we've learned is a major factor. We've learned that the bow is much stronger. We've proved that, actually. You make assumptions when you do your engineering based on what you can see, and you always engineer from a conservative standpoint. If you look at any of the rigging or anything else we have out there, we are normally putting in safety factors. That's part of an engineering design.

So we will continue with what we've got right now.

Q: What obstruction did you find at Frame 41 that forced you to make the switch?

Marsh: Basically when we lifted, in the first diagram, we had it up far enough that we felt that we could run a wire through, but we in fact caught repeatedly in the Frame 41 area. My estimate would be that that may be part of the keel of the ship of the EHIME MARU.

Q: How are these recent modifications affecting the budget for this operation?

Marsh: When you, if you go back and look at the initial estimates, we labeled them just as that, as initial estimates, based on our assumptions of how long we would be here. So we will reevaluate as we go.

I don't know exactly how long it's going to add to the process yet. I can't answer you in real dollar...

Q: ...costing more than \$40 million?

Marsh: There's that possibility. I can't give you any specific numbers right now.

Q: I had a question on the dredging. Is the dredging to free up the anchor holes? I got the impression...

Marsh: No, the dredging, as you mentioned, is in fact designed to get ourselves in a position where we can rig the lifting sling up in the bow, which means we have to get at the anchor hawse pipes. They are currently buried in the mud.

Now what we are doing is we have the capability to dredge with the ROVs as they are set up. They basically use the impellers on the ROVs to suck the silt away. But that's inefficient, so we are flying in from the mainland some extra pumps. I didn't mention it in here, but one of the reasons we're confident in what we're doing is we used a piece of gear we call the hydraulic power unit and that was very effective when we were doing the coil tube drilling effort. We proved to ourselves that we were capable of making that up, those hydraulic



fittings, at 2,000 feet safely, and the pumps all worked perfectly from that standpoint for the coil tube drilling. So we think we can do the same thing, lower the hydraulic power unit down through what's called a moon pool on the ship itself. She has holes in her deck that allow us to lower things. We will lower down the HPU, the hydraulic power unit, to the bottom, connect it up to some dredge pumps that are coming in, being flown in from the mainland, and that will increase the speed of the dredging operation.

Q: How much (inaudible) is there? The (inaudible)?

Marsh: As the picture depicts, the mud line is just about even with the focus. However what you have is, somebody was asking me this question earlier, as you look at it through the ROV, depending on the angle you look at it, the ROV could be up here looking or it could be sitting down here. What you see is it's mounded up a little bit on the sides, but when you get in close you find out that this is pretty accurate. That you're only talking a meter, meter and a half of clearance right there, which means that the anchors which are down in here, we can't get at right now.

Q: How deep are the anchors then from the top? Do you know how deep they are?

Marsh: I don't know that answer off the top of my head. I'll have somebody get back to you with them.

Q: Can you give us your best estimate of what day you think you'll be able to lift the ship again? And you gave yourself a two month window when this process began because of weather considerations. Where does that stand?

Marsh: As I mentioned, we're looking at this as a milestone event, rather than laying out a schedule and saying if I'm not meeting that schedule I have a problem.

We will report as we get close to those milestones. No, I can't give you a specific date for that just yet. It depends on how long the dredging takes and how long the connection to the bow takes. So we'll let you know when we're getting close and advise everybody.

Part of the environmental assessment was that we advise whenever we move the vessel herself, so we will be advising the public basically when we get into that position again.

Q: What happens if this method fails?

Marsh: We try to always have something in the back pocket to step on to something else. There are multiple variables that you have to deal with.

## **F/V EHIME MARU Recovery and Relocation Report**

Up to now we've been in a position where we've been able to move on, first reassess where we're at, and then move on to another method if necessary. It's really evolution. So if we have a problem, I think we will be able to evolve into another solution for it.

The team out there is really a very determined group. It's become a real challenge to them. And I don't see anybody giving up, and I don't plan to.

Q: Why do you think the stern lifting strap failed and what makes you think that the lifting plate is strong enough to hold the ship?

Marsh: The difference being, if you'd go to the first slide, I'll show you some differences there in the way that they are loaded, is what it boils down to.

As we used those straps initially to lift the stern, what you have happening here is you purposely are putting an angle on the vessel. As that angle increases, what happens is this strap right here comes up against this post so it actually deforms. That deformation means that it is not as strong as it normally would be.

In the situation that we found ourselves in, was basically that we lifted the first time without reinforcement wires behind, and in that case we actually parted the straps. It was a controlled evolution. Nothing was harmed on the EHIME MARU or anything else. We made the decision to lift her. We actually had her up for eight hours. At that point we thought we had passed the wires forward and in fact they were not as far forward as we thought.

You must understand that while we have the vessel up in the air, she is moving very slightly, but that is creating a continual dust cloud. Silt cloud. It's not dust down there, but it's silt. That is spilling out continuously. So the ROVs in their working around there basically lose visibility.

I gave an analogy awhile back about the ROVs trying to do something down there as take one eye and cover it and work with your hands, but remember you have no feeling whatever with the ROVs. So when you lose visibility with that one eye, you can't tell whether you have ahold of anything at all. You have no idea. So you have to wait for the visibility to clear.

So that visibility issue caused us the difficulty that first caused us to set it down the first time, thinking that we had actually passed the messenger far enough forward. We were confident with the after one that in fact it was in the position that we wanted it. The first time we lifted it we got that after stern wire messenger in the position we wanted it.

That's sort of a long-winded answer, but when we pass these underneath they will not be coming up against anything solid moving back and forth. The vessel, the whole idea of the plan is to lift the vessel level and keep her level throughout the lift. So we will not be loading the plates from the side like we were in the stern.

When we went out the second time with that second plate, in fact it did not part. The steel part of it, the steel plate parted, but the wires still held.

Q: Are you using the same type of steel on both the strap and the plates?

Marsh: Yes. When I said the steel plate in that case actually parted, it stayed in position, though. So even though it wasn't helping in maintaining the load of the vessel, it was providing chafing gear for the wires. The wires were capable of holding the vessel up.

Q: An environmental question. At one point you said there was 45,000 gallons of diesel fuel. Yesterday the Admiral said it. Why did you change that figure?

Marsh: I'm not really totally involved with the environmental side. I'll pass that question on if I can to the CINCPAC Fleet people. They have been tracking with the regulators on any oil releases that have happened. I sort of had my head glued to the actual lifting process itself.

Q: Have you taken samples of the sediment and performed assessments on them? And if you have, what were the conclusions?

Marsh: We actually took samples back long before we came out to see, we had those analyzed at a couple of different universities. What they told us at that time really was that what we thought would be very effective was the coil tube drilling arrangement. That proved not to be quite... In fact it didn't work like we had planned. But what we did was take those samples and compare them to shore-based testing that we did. And the shore-based testing we did with the coil tube drilling actually was much tougher, much more solid soil. So that's why we felt confident that the coil tube drilling would work.

Q: Can you describe, you're talking about lifting the bow with the strap in front. I guess I'm a little...

Marsh: It's a lifting sling, I would call it that because it is not strapped around, it is strapped through the hawse pipe, but there's no plates or anything that is continuous around the bow.

## **F/V EHIME MARU Recovery and Relocation Report**

Q: I guess my question is if you have that sling in place it will be teetering (inaudible) what you were talking about when you lift up the stern.

Marsh: Not quite. The answer to that is as you pick... Probably this one. As you begin the pick or the raising of the bow, what you will see is you are initially, she's down in the mud and you start raising the bow you will simply be lifting the bow area weight. She's supported back here where she will actually lever. So we are taking advantage of the weight of the ship itself.

We're going to take advantage of this weight right here on almost, most all commercial ships and a lot of warships are the same. You actually look at it from the midships area which is Frame 45 on this vessel. Aft you normally have 60, maybe 65 percent of the weight of the entire vessel. It comes about simply because most of the major machinery is back there, so you have very beefy, a good term I guess from that standpoint, support system back there. So therefore the weight distribution of this ship is skewed to the stern.

So as we start lifting on the bow we will take advantage of this to help coming up. So we won't be pulling nearly as much as it may seem. It's basically a teeter-totter from that standpoint.

Q: Is the hawse pipe strong enough as opposed to lift the stern? (inaudible) anchor was.

Marsh: The anchor hawse pipe? Yes.

Q: (inaudible)

Marsh: Yes. And as I mentioned, our Japanese experts on board confirm that with it. They helped us design the size of those backing plates that will be coming up. So you are not, the picture may be, or the thought pattern may be that you're actually lifting with this shackle pulling up through that hawse pipe, but the shackle will come up against a large plate. That large plate will distribute the load over, in fact, three frames worth of the ship. Frames on the ship are essentially like your ribs, really, from that standpoint. They're major structural members.

Q: How big is...

Q: I think that was about it.

Marsh: I've got to get back out...

Q: ...the plates?

Marsh: I think right now the design is 1.3 square meters.

(END)

# TRANSCRIPT Rear Adm. William Klemm: EHIME MARU Relocation Brief

CPF HOME EHIME MARU RECOVERY NEWS

## U.S. Pacific Fleet Public Affairs

### PRESENTATION SLIDES

---

Oct 9, 2001 -- Rear Adm. William Klemm: Thank you all for coming again. We're here today to update the status of the EHIME MARU recovery operation.

I want to pick up basically where we left off last time. The last briefing that we had we discussed the current condition of the ship at that time which was the configuration that you see here in this drawing down by the bow, and with a messenger line passed under the stern. Basically we took advantage of the fact that the stern was off the bottom to install a lifting plate. We pulled the lifting plate underneath the stern and installed that and then began an operation which included dredging out around the anchor hawse pipe that you see here and cutting the anchor chains, and I think most of you realize that we've already removed the anchors and brought them ashore. The status at this time was the beginning of the rigging of the bow so that we could lift the bow up out of that hole that it sits in. The remainder of these slides will show you how we accomplished that feat and what our current status is.

We passed a large bridle assembly down through the haws pipe, on one side and up the other, and connected it to one of the linear winches up on ROCKWATER2. We took the other linear winch from ROCKWATER2 and attached it to the stern. We made up the lifting strap aft, and then lifted the entire ship by the stern strap and by this forward lifting bridle.

We were very much concerned, of course, that the damage the ship in this area would give way or potentially deflect. That did not occur. The structural integrity of the ship was greater than anticipated as we had said in previous briefings, and as a consequence, this lift went without a hitch.

We placed the ship down on top of the forward lifting strap and that strap then was adjusted to center it and was then made up to the spreader assembly. And the bottom line configuration of the ship as it sits today is with the full lifting frame and both lifting straps installed. It is ready to be lifted.

The top frame assembly was raised back up to ROCKWATER. They came back in port on Sunday to re-rig the forward sheave to the linear winch. That rigging has been done, and at noon today ROCKWATER got underway to return to the deep water site.

What we anticipate now is once ROCKWATER is over the site they will lower that top lifting frame, interlock into the spreader assembly, and EHIME MARU will be ready for its final transit.

This status, if you will, is a projected status, obviously. We have not lifted the ship yet. And I wanted to point out that there are a number of conditions that will permit us to safely make this lift and transport the ship into the shallow water site.

The first is the sea state. We're seeing anywhere from eight to ten foot seas out in between the islands right now. We have very strong tradewinds, 30 knots and gusts higher than that. Wind-driven seas are pushing our total combined sea state, so we expect that somewhere around Wednesday night or Thursday this front will pass north of us and as the high pulls out it will leave behind a reduced tradewind. It won't go down as low as it did a week ago. We still expect 15 to 20 knot winds. But that should get the sea state down into a range where we can make the lift safely.

It's important for everyone to understand that just the size of the waves is not the only controlling factor. The period or the time between the waves is extremely important. As a consequence, the on-scene commander, the folks that are out on the ship will actually make the call when it is safe to lift the EHIME MARU and begin the movement operation. Right now we would not expect that to happen before very late Wednesday night or Thursday morning at the earliest.

Once we have in fact lifted the EHIME MARU in this configuration we will go through a series of checks. There will actually be three ROVs involved. One of the ROVs will do an under-body structural examination; one will maintain a watch on the lifting equipment above the ship; the other one will do a quick survey of the ship and then precede the ship as it moves into the shallow water site. So there's a complicated affair here that's orchestrated to ensure that the ship and the lifting equipment is stable and prepared to make the move. That will take several hours.

Once we start moving the ship to the shallow water site the expected speed when we start will be as low as .2 knots. That's very, very slow. It will be almost imperceptible to the eye. It will take hours and hours to travel a mile at that rate. So no one should expect that we're going to see a wake following behind this ship. In fact ROCKWATER will probably be backing in with its bow into the seas, and depending on where the seas come from in the

## **F/V EHIME MARU Recovery and Relocation Report**

period may rotate itself so that it's traveling sideways as it comes in. When it transitted from the deep water site into port on Sunday it did transit sideways all the way through the downtown channel into Honolulu. That's because the lifting equipment is oriented perpendicular to the hull. So in order to reduce the drag and in fact make the ship, the EHIME MARU ride smoother underneath, we need to keep the orientation of ROCKWATER into the most prominent sea state. So you may see it backing in, you may see it coming in sideways, but again, you'll need a micrometer to measure the speed. It's going to be very slow, intentionally so, and we expect that that could take as long as three to four days to make that transit, about 14.5 miles from the deep water site to the shallow water site.

Once we're at the shallow water site the ROCKWATER will disconnect and leave. She will come downtown, offload equipment, and then depart. We will, the following day move the 450, Crowley 450 dive barge over the top of EHIME MARU and we'll do some survey type dives on the second day and begin dives on the ship on the third day after it's set down.

So again getting an appreciation, three to four day transit time, two to three days on the shelf before we begin our internal diving operations. So a week after we have announced the lift before any serious operations begin.

Once we have begun the diving operations we expect to be diving for about 33 days. That is very dependent upon the internal condition of the ship, which is unknown at this time. But at this point anticipating that we will have access to those spaces, we will anticipate a 33-day dive plan.

I'd like to emphasize, as we have done at all the previous briefings, that this is an unprecedented evolution. There is still risk involved. I think we have reduced a considerable amount of the risk as we have seen in the lifting of the ship and the placement on the forward lifting strap. However, it's never going to be zero. So as a consequence, we should understand the potential for equipment failure or ship failure during this move is still there.

Further, after we get to the shallow water site, recognize that there may not be nine sets of remains on board as has been discussed in the past, so our expectations should be realistic. We will find some of those and probably not all of them. I will emphasize that everything we do and have done from the very beginning has been predicated upon safety. We've had a tragic event here. We've lost some lives. And we cannot justify any further loss of life in this operation. So the people in charge on board ROCKWATER as well as the divers in port have not only the responsibility, but are charged with maintaining safety above all other criteria. That means if they have to set the ship down, if they have to stop the operation, if



they have to put it on hold, or they have to remove people from the hull after diving has started, they have the authority and the responsibility to do so.

I think we have very high confidence in this operation and we expect to succeed. Expectations what they are, you also have to recognize there are some potential downfalls here.

A little bit later on today we should be providing some footage from the bow lift evolution itself, probably around 5:00 o'clock, between 4:00 and 5:00 o'clock this afternoon, I believe. That film footage is, unfortunately, largely obstructed by the amount of sediment that was disturbed in the move itself, but you can clearly see the lifting equipment as we began to take a strain on it, and we can see the bow completely up out of the silt, sitting high with the lifting gear under it. So there are some at least short clips of video there that would provide some additional information for you.

With that, that concludes my formal comments. We'll take some questions at this time if you have any.

Q: How many bodies do you expect to find?

A: I think we've said in the past that the number is probably in the five to seven range, based on where the folks were last seen.

Q: How high will the EHIME MARU be off the ocean bottom as they transport it into shallow water?

A: We expect it to be about 90 feet. As I explained this before, I guess probably not in this environment, but let me just give you a quick picture here.

Remember that we've got the ROCKWATER perpendicular to the EHIME MARU so what you're seeing here is these lines rigged over the side of ROCKWATER. If either one of these lines fails, the winch fails, or this lifting equipment fails on one side, then all the load is shifted to the ROCKWATER on one side and it will cause ROCKWATER to take a very significant roll. If that occurs, then obviously we have the potential for not only injury to personnel but equipment flying all over the place and some real nasty things could happen. In order to avoid that we need to keep the ship close to the bottom so if there's a failure then the EHIME MARU comes to rest on the bottom before it does serious damage topside.

## F/V EHIME MARU Recovery and Relocation Report

So we will transit with probably about 90 feet under the EHIME MARU. As we come up the incline and the shelf into the shallow water site. So one of the ROVs will be preceding the ship. We have a regular convoy, if you will, of ships that will be escorting. Sumner will be in front. USNS Sumner is an oceanographic research vessel with a lot of the bathymetry equipment on board. They will be keeping a bottom profile, depth, and current information which they feed the ROCKWATER. As that incline, as it climbs, they will be passing that information to ROCKWATER, continually raising EHIME MARU to match the bottom profile.

Following along behind will be SALVOR, USS SALVOR, which will be used in one of several different roles. The primary role is to provide an ROV which does deep ocean search in the event that we have something come off of the EHIME MARU during the course of the transit. They'll also stand by for security and recovery operations if someone should go over the side. ROCKWATER would be unable to recover anyone that fell off of their own ship, so we have to provide that.

JDS CHIHAYA will also be out there in escort. She is currently out doing bridge surveys of the underwater area where the EHIME MARU had been located and she'll be following in as well. So there will be a small convoy of ships including the Coast Guard. Clean Island Council, the oil recovery vessel will be out there as well. So a fairly significant number of ships all providing a different piece of input to the movement operation.

Q: Have your resources been affected at all by the air strikes and the current situation?

A: Not really. Let me explain that.

Most of this effort up to this point is contracted so Smit and Crowley, the prime contractors in this evolution, have continued to work. The Navy folks that are involved in this process are divers right now who have not been tasked for other missions so we do not expect to stop this mission at this point. It's unaffected.

Q: Is it possible that the relocation (inaudible) may [charge] Wednesday night, late Wednesday night? Will it be a continuous night and day operation once (inaudible)?

A: Generally speaking, it would be. We have some very specific criteria for crossing the shelf and into the shallow water sites that are specified in the environmental assessment. They include our ability to control any oil releases that might take place, for example. There will be an armada of oil skimmer equipment out there booming in place and so on. That is all designed through the EA to deal with that problem should it occur. Our expectation that it will occur is fairly low at this point, so we don't expect that to be a problem.

But to get to the heart of your question, the transit portion is kind of continuous. But once we reach the shelf we have to have a confluence of wind, current, sea state, and tide in order to cross that shelf and go into the shallow water site and that gives us the maximum protection under the environmental [potentials].

Q: Are there any more difficulties working through the night than there would be during the daylight hours?

A: Not really. As you probably know, we've been working 24 hours a day on this project since it started. The darkness at the depth that they're working at now is the same in the day time as it is at night. ROVs provide their own light, and this entire operation right up to the point where the ship is set down in shallow water will be an ROV evolution.

So the day light is really for us humans to be able to see the oil release if they occur in that last couple of miles.

Q: Admiral, have you ever had an operation where you dragged something across the ocean at this depth?

A: I would not characterize it as dragging it, because that implies contact.

Q: How would you characterize it?

A: I don't think we have any precedent for movement of a vessel of this size from that depth period. We've recovered much larger ships from much shallower depths, but the movement itself is very unique. I'm sure you realize that the KURSK for example was lifted earlier this week -- a much larger vessel from a much shallower depth. There is lots of experience in that environment -- very little in this environment.

Q: Without getting too technical, how do you keep the ship directly under the ROCKWATER? Assuming that's the way you move it.

A: Yes. Basically what it amounts to is at this depth these wires which are 4.5 inch diameter, 115 millimeter, so a two-part lift with very heavy cable acts almost as a solid rod. And so the things that affect the EHIME MARU at that depth are primarily the current and the speed of the ROCKWATER. That's why the speed will be greatly limited, because we do not want to encounter current which will cause EHIME MARU to depart from a straight path in.

## F/V EHIME MARU Recovery and Relocation Report

As I mentioned, the orientation of the ship as it travels, when we back in with the ROCKWATER, this is the profile that you will see coming at you. So ROCKWATER would literally have to turn sideways and move towards the shore sideways in order for EHIME MARU to be aligned bow first in the transit. If the conditions call for that that's what they do. The ROCKWATER has the capability of moving in any direction up to several knots in speed, so if she has to move in sideways and that's the best configuration, that's what we'll do.

Q: Do you have any idea how long it will take from the deep water to shallow water?

A: About three to four days. Very slow. Probably, my best guess right now is between .2 and .5 knots. I don't think we will exceed .5 knots, a half a knot, half a nautical mile in an hour. Fourteen miles, you can figure it out, it takes a long time to transit as well as lifting. The lifting operation will be done fairly slowly. We can raise about one meter a minute. We have to come up 600 meters. So you can do some calculations there and figure out there's a number of hours involved in raising this thing. We will be incrementally raising it as we move, but if the incline becomes too steep, we'll have to stop to continue to raise it.

Q: (inaudible)

Q: Admiral, what is the greatest risk at this point? Is it equipment failure? Is it...

A: I would say probably the greatest risk, given weather. If we have adequate weather the greatest risk is probably equipment. We think the EHIME MARU is sound. We won't be 100 percent certain of that until we have an opportunity to survey the bottom with ROVs, but that will be the first step before we actually start moving. So assuming we verify that the structural conditions are sound, then primarily the risk is in the lifting equipment.

Q: What are the maximum sea states that you'll be able to do this in?

A: I was afraid you were going to ask that. This has more moving parts than anything you can imagine. There are six degrees of motion in Rockwater, six degrees of motion in EHIME MARU, and a computer program that ten years ago would have been too complicated to run.

We calculate dynamic amplification factors which tell us what the shock loading on this ship is. If you can imagine this thing is on a wire that is essentially solid. As the ship on the surface moves up and down and heaves, then it's raising and lowering the EHIME MARU against the resistance of water on the hull. If you jerk it, then you impart tremendous energy

and the potential for breaking the ship exists. So the dynamic amplification factor is how we measure that.

The sea state by itself is not the only criteria. There's about 20 variables involved in this thing. So we could have a four foot sea state and not be able to move based on other criteria. But the bottom line is we think if we get down to in the six foot range with the right period of waves that we probably can lift the ship safely. That's not a rule of thumb, that's just kind of a statement. We have some empirical data now from our experience of lifting the bow of how it reacted in a sea state, and we have those calculations. So we have kind of validated what our expectations were.

Q: Is there any new plans or subsequent plans that would help in preventing additional mishaps during the transit period that have now come into play that wouldn't have been in play three or four weeks ago?

A: I don't think so. We have, as I mentioned, probably the most difficult challenge we face in lifting the ship successfully is in the wave height and the period. If we look at where waves come from this time of the season, we get sea swells from the south that have a longer period, and we get wind-driven seas that come primarily out of the east and in between the islands. So these two seas are running perpendicular to each other. Where they cross, they make a combined sea state which is what the ship sees in terms of motion.

For the first six miles or so of this transit the ship will be exposed to both of those sea states -- swells and seas driven by the wind. We will not move unless we have a window that will allow us to travel that first six miles. Once we pass that six mile point or approximately six mile point, we reach the lee that Oahu provides between the islands. That knocks down that wind-driven sea dramatically. So the condition continues to improve the closer into the shallow water site we get. So our immediate criteria is we need to have a window of time that allows us to make that transit uninterrupted. We don't want to have to set the ship back down.

Q: At the same time we're fighting against perhaps greater impact the further we go...

A: Yes, there's no doubt. And every month... We've had this plotted out fairly accurately for a long time. We've known that the risks of weather, the later we get in the year are higher and higher. That doesn't mean you won't have a window, it just means that historically there's a longer period of time between windows.

So what we're looking at right now is if this opportunity presents itself then we're going to pick it up and go.

## **F/V EHIME MARU Recovery and Relocation Report**

Q: How successful do you expect the Navy will be to take the EHIME MARU to shallow water, and (recover) five or seven more (crewmembers)? How successful and (inaudible)? Please provide the reason why.

A: When we initially set out to undertake this operation we concluded that based on our calculations we had about an 80 percent probability of success. We think that based on the experience of this past weekend that we're probably up in the ball park of 90 percent success rate right now.

Once we have the ship in shallow water I have no doubt that we will be able to enter the ship. We have the equipment to do that and to remove, recover the remains. So I have a very high confidence that once we're in the shallow water site we'll recover remains and personal effects.

There is a probability and a possibility that the inside of the ship is so severely disrupted that we would endanger the lives of our divers to go in there. In that eventuality we have a very small ROV, literally the size of a bread box, that will be used to go into those compartments to do the survey for us. And if we then have to go into those compartments we'll determine what the course is at that point.

So I think we have a very high probability of success once we're up there, and I would guess close to 90 percent probability of success in moving the ship.

Thank you all very much.

(END)



